

WILL ROGERS REMEMBERED

1879-1979

the
Elks
magazine
November 1979



No. 87 New York, N. Y., Lodge No. 1,
B. P. O. ELKS



THIS IS TO
CERTIFY THAT
WILL P. ROGERS
IS A LIFE MEMBER
in said Lodge since the 29th day of March 1945
Member's Number 4235
Will P. Rogers
1925-26

Not valid unless signed by the member to whom this card is issued

The Greatest Executive Shoe Value In America!

100% MAN-MADE
IN U.S.A.!

**\$90 LOOK
ALLIGATOR
GRAIN
LUXURY
SHOES**

2 PAIRS
FOR
ONLY
29⁹⁵

**IF YOU ACT
PROMPTLY!**



NAVY

BLACK

BROWN

**NOT \$90
FOR THESE EXECUTIVE
DRESS SHOES!**

Here is the great new look being worn by the nation's top young executives. But in fact, many of the best dressed men you see around are not shelling out \$90 or \$100 per pair for genuine reptile skin shoes! Instead they deal direct with Haband, the mail order people from Paterson, N.J. They get the style they want, save big money on the purchase price, and save expensive wear and tear on their costly leather shoes as well!

It's true! Haband's remarkable man made reproductions are soft and supple, give extremely long wear, and never need a shine! And you can order them direct from home or office without using even a drop of gasoline for shopping.

With more than two million active customers, we keep a huge stock of fine shoes on hand for immediate service. And we will be proud to send you any two pair on No Risk money-back approval. For a thoroughly satisfying and efficient transaction, just fill in this easy order form.



HABAND 265 N. 9th St.
Paterson, N.J.

TO KEEP THIS COVER INTACT
USE COUPON ON PAGE 60

START ENJOYING IT SOONER—
VISA and Master Charge Card Holders can order by phone,
Call Toll Free 800-621-5809
(In Illinois call 800-972-5858)
24 Hours a Day—7 Days a Week

Haband's remarkable 100% man-made reproductions
ORDER DIRECT! **2** PAIRS FOR ONLY **29⁹⁵**

HABAND COMPANY
265 N. 9 St. Paterson, NJ 07530

GENTLEMEN: Please send me pairs of the deluxe executive dress shoes as specified hereon, for which I enclose my \$..... plus \$1.30 to help toward postage and handling.

GUARANTEE: I understand that if I am not 100% pleased I may return the shoes within 30 days for full refund of every penny I paid you.

PRODUCT NUMBER: 72L-464

IS YOUR SIZE ON THIS CHART?

	5½	6	6½	7	7½	8	8½	9	9½	10	10½	11	12	13
A														
B						✓	✓	✓	✓	✓	✓	✓	✓	✓
C														
D	✓	✓	✓	✓	✓	✓	✓	✓	✓	✓	✓	✓	✓	✓
E														
EEE														

Take All Three — Only \$44.75

Color	Size	Width
Black	1	
Brown	2	
Dark Navy	3	

Name _____

Street _____ Apt. # _____

City _____

State _____ Zip _____

Or Charge VISA MasterCharge } Acct # _____

Exp. / / _____

(We need your opinion)

A system with remote for less than the other people charge for just a telephone answering machine

This ad's a test. A kind of consumer survey. With a special Free Offer. To see if the low price of the new Call Jotter remote telephone answering system can turn one of the biggest selling business items into one that's successful with consumers, too.

Ordinarily, information like this comes from a consumer panel. Focus groups. But the manufacturer wasn't about to commit for the enormous sum required based on talk. He wanted facts. And came to us, as one of the largest mail merchandisers, for help. Because orders are facts he could act on.

Quality Features

For our part, we tested the Call Jotter thoroughly. And can tell you it's exceptionally well made. (It has to be to get our guarantee.) With solid state, microprocessor technology and plug-in simplicity. It's F.C.C. approved. And delivers the freedom and convenience you get with systems selling for \$299.95—which is the going price, as you know, for remote telephone answering machines.

One thing we did tell the manufacturer: something extra should be given to those who participate in this test. He agreed. So, you'll receive with your order a FREE professionally recorded tape that answers and records 30 messages... a FREE blank tape for recording your own messages or for when you're using the machine as a cassette recorder and player... plus a FREE adapter for connecting the Call Jotter to your telephone jack.

An Extraordinary Convenience

Now, we ask you, how much would it be worth to you, to your wife, even your teen-age children to never miss or worry about a phone call again? And to get your messages without having to wait until you get home—from any phone, anywhere in the world. Resetting the machine to take 30 more messages by touching a button on the Tele-Key remote control.

Of course, you'll use your Call Jotter to answer the phone when you're working outside and when you're in a part of the house where there's no telephone.

How much would you spend for an answering machine when the phone rings and you're up on a ladder painting the house? It's true—isn't it—the phone always seems to ring at exactly the wrong time. Like the critical moment in your favorite show and whenever you're taking a nap.



Get your message from any phone anywhere in the world.



Think of the time you've spent just waiting for someone who's promised to call. And what value do you place on your privacy... on working without interruption?

Because your Call Jotter has a monitoring system that lets you listen without answering, you can go back to what you were doing the instant you know it's a nuisance call or for someone who's out of the house. Naturally, you can take any call that's important.

Two For The Price of One

For additional value, Call Jotter works with a single cassette, like a pocket recorder or dictating machine, so you'll use it to listen to your favorite tapes and for recording your own tapes, for dictating letters and memos to be transcribed at the office.

Save \$130.00!

You'll use your Call Jotter, then, when you're away—whether it's running to the corner store or spending a month in Europe.

Still—we agree, you probably wouldn't want to spend \$299.95 for something that isn't business related. With Call Jotter, though, you save \$130.00! And that's a different story.

At **\$169.95** (plus \$4.35 shipping and handling) Call Jotter's the lowest priced remote telephone answering machine you can get. (Without the remote, it's even less, only \$99.95 plus \$4.35 shipping and handling.)

Now, we invite you to discover the convenience and freedom it brings—especially if you're an active family—without risking one cent.

You can order either model with any national credit card simply by calling the toll free number below at any time. If you prefer, send your check to Douglas Dunhill at the address below. (Illinois residents are required to add the sales tax.)

Call 800-621-5554

Illinois Residents Call 800-972-5858
In operation 24 hours, 7 days a week

Remember, the low, down-to-earth price includes the Tele-Key remote control and the two FREE tapes plus the FREE adapter that fits your telephone jack. (If you don't have a phone on a jack, the telephone company will install one for a modest, one time charge when your system arrives.)

You Must Be Satisfied

Use your Call Jotter for 30 days. If you're not completely satisfied return it to us for a complete refund, no questions asked. Simply use the carton it comes in and follow the simple procedure in the directions we send you.

If this test is successful, the manufacturer will go into full production and you'll be seeing the unit in stores everywhere in six to nine months. You'll have played a part in this success—for which we thank you. Meanwhile, we'll be filling orders while we can from the supply on hand.

- Approved for connection in accordance with telephone company filed F.C.C. regulations
- Uses standard 60-minute cassettes
- Plugs into any phone on a jack with adapter supplied free
- Dynamic microphone, full fidelity speaker, push-button tape controls, call light, recorder-player operates on standard A.C. current
- Tele-Key complete with 9V battery for remote control from any phone anywhere in the world (2" x 3" x 1"—4 oz.)
- Hi-fi styling. Black and walnut color. Just 9½" x 10½" x 2¾"

The convenience and freedom you want... At the price you've been waiting for.

Douglas Dunhill
INC. AFFORDABLE QUALITY

Dept. 50-1611
Ten Douglas Dunhill Drive, Oak Forest, IL 60452
© Douglas Dunhill Inc. 1979

"I am determined to carry the true message of Elkdom into every corner of every state in this great country."

UNITE AND EDUCATE



A
MESSAGE
FROM THE
GRAND
EXALTED RULER

Dear Friends:

I HAVE TWO items on my mind this month—first, of course, is to wish everyone a happy, relaxed Thanksgiving. This short holiday has always been one of the most enjoyable, with the traditional family gathering while offering our "thanks" for the wonderful things we enjoyed during this past year. The thought of turkey, dressing, mashed potatoes and gravy, pumpkin and mincemeat pies makes my mouth water while I write.

MY OTHER TOPIC concerns something which occurred at our recent Grand Lodge Convention in Dallas, which, I have been told, was one of the most enjoyable in recent years. The people of Dallas went out of their way to extend a warm Texas greeting to all Elks. Those attending enjoyed the business sessions, visiting neighboring lodges and the general camaraderie associated with such an event.

THERE WAS only one incident that marred an otherwise most enjoyable convention. A newspaper reporter approached several Elks, who were "trading" various insignia badges and lapel stick-ons, and wrote a story quoting those Elks concerning their reason for attending the convention and, in addition, relating their view of our Order.

IF THEY were quoted accurately, they indicated the Elks were simply a fun organization, and it was obvious they had little appreciation for what Elkdom really means. It brought home to me the point that a very, very small minority of our members can project a greatly distorted public image.

THIS KIND of lack of understanding does our Order irreparable harm wherever it occurs, and reminds me that we have an internal educational process which must be pursued with vigor.

THOSE OF US who work in Elkdom and are intimately familiar with its tremendous humanitarian efforts, which are producing untold benefits for the dependent-elderly, the handicapped, the children of America, and for mankind in general, lose sight of the fact that not all of our members realize the basic reason for Elkdom.

I AM DETERMINED to carry the true message of Elkdom into every corner of every state in this great country. We shall not allow the misconceptions of a few undermine our work. Rather, we shall educate them into an understanding of our Order, and soon have them working along with us.

I CANNOT achieve that objective by myself, and I will close by respectfully asking for your help in this endeavor.

A handwritten signature in dark ink that reads "Robert Grafton". The signature is written in a cursive, flowing style.

Robert Grafton



The Funeral

*It helps you remember the yesterdays.
And move on to tomorrow.*

The funeral fulfills people's age-old wish and need to honor their departed through a dignified ceremony. Determined by custom and culture, the funeral symbolizes the beliefs and hopes of society. For many, it is firmly rooted in religious concepts. But, more importantly, the funeral is a service for the living, helping persons prepare for the future.

Your funeral director is the sensitive and conscientious professional who will assist you in planning the appropriate service to meet your needs.

As America's foremost manufacturer of

quality burial vaults, Wilbert is also a vital part in the funeral, providing families the very finest in underground protection. For this enduring protection, Wilbert brand name burial vaults are selected by most families nationwide. Because you care, we care, too.

Wilbert offers a free booklet called "FACTS every family should know", which has information you will find helpful at the time of a death in the family or of a friend. Ask your funeral director for a copy . . . or simply send in the coupon below.

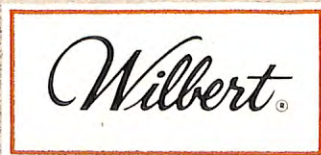

Providing quality when it is needed most



YES! Please send me a free copy of "FACTS every family should know"

Name _____

Address _____

City _____ State _____ Zip _____

WILBERT
P.O. Box 147E
Forest Park, IL 60130



Haggars® slacks... proportioned for Tall and Big Men. 100% Dacron® Polyester for machine wash and dry. Belt loop model with quarter top front pockets. Add \$1.50 for Finished Bottom. No. 8516 Grey Heather.

QTY.	STYLE & DESCRIPTION	WAIST & INSEAM	PRICE
	Even Sizes 34 to 40 Inseam to 38 (Flares)		
	Size 42 - Inseam to 36 (Flares)		
	Even Sizes 44 to 52 Inseam to 34 (Straight Legs)		

Check enclosed
 Charge my Credit Card

Shipping & insurance \$2.50
TOTAL AMOUNT

AMERICAN EXPRESS VISA MASTER CHARGE

CARD NO. _____

4-Digit Interbank No. _____ Month Year _____
 _____ Expiration Date _____

Signature (as it appears on your card)

My Telephone Number _____

Name _____

Address _____

City _____ State _____ Zip _____

CHECK HERE FOR FREE CATALOG

King-Size 4489 King Size Bldg.
 Brockton, Mass. 02402



WOOD BURNERS!

AVOID DISASTER!

IF YOU BURN WOOD YOU OWE IT TO YOURSELF TO KNOW EVERYTHING POSSIBLE ABOUT CHIMNEY CLEANING AND SAFETY.

NEW MANUAL gives inside scoop on • how to know when to clean your chimney • creosote buildup • what to do about a chimney fire • cleaning fireplaces, stoves, stovepipes, and chimneys from inside or out.

Also includes advice on hiring a sweep, chimney sweeping as a lucrative home business, best woods to burn, insurance protection for woodburners, new safety standards, and personal anecdotes.

"An important manual that should be in every wood-burner's reference library."

BE YOUR OWN CHIMNEY SWEEP—At leading book and hardware stores nationwide or direct from publisher. Mail \$4.95 plus 60c postage and handling to:

GARDEN WAY PUBLISHING CO.
 Dept. 9012N, Charlotte VT 05445

NATIONAL PUBLICATION OF THE BENEVOLENT AND PROTECTIVE ORDER OF ELKS OF THE UNITED STATES OF AMERICA. PUBLISHED UNDER THE DIRECTION OF THE GRAND LODGE BY THE NATIONAL MEMORIAL AND PUBLICATION COMMISSION.

THE ELKS NATIONAL MEMORIAL AND PUBLICATION COMMISSION

WADE H. KEPNER/Chairman
 R. LEONARD BUSH/Vice-Chairman
 RAYMOND C. DOBSON/Secretary
 EDWARD W. McCABE/Treasurer
 ROBERT E. BONEY/Asst. Secretary and Asst. Treasurer

JOHN R. RYAN/Publisher/General Manager
 DONALD STAHL/Managing Editor
 SUSAN ALBERT/Fraternal News Editor
 SHIRLEY STERLING/Advertising Manager
 MALCOLM B. CROFFORD/Circulation Manager
 EDITORIAL OFFICES, 425 W. Diversey Parkway, Chicago, IL 60614

6 Lady Luck

Jean E. Laird

"Throw a lucky man into the sea and he will come out with a fish in his mouth."

12 Will Rogers Remembered

On the centennial year of his birth, we pay tribute to Will Rogers, a true Elk who loved his fellowman.

16 The Cadre Noir: France's Brilliant Equestrians

King Harris

The Cadre Noir has often been called the French equivalent of Austria's famed Spanish Riding School.

34 Mass Mayhem: The Early Years of College Football

Stewart Marsh

In football's early days, players slugged opponents with their fists, jumped on fallen foes, and kicked each other more often than they kicked the football.

Departments

- 2 Message
- 8 Elks National Service Commission
- 10 It's Your Business: Young Workers
- 19 Letters
- 20 You and Retirement: Keeping Fit
- 22 Elks National Foundation Scholarship Awards
- 23 News of the Lodges
- 28 Medicine and You: Salt
- 38 News of the State Associations
- 41 Grand Lodge Officers and Committees
- 46 Visits of Robert Grafton
- 47 Travel: Fantasy Land
- 50 Elks Family Shopper
- 68 Did You Know?

ADVERTISING OFFICES



CHICAGO 60614 425 W. Diversey Parkway (312) 528-4500
 NEW YORK 10017 50 East 42nd (212) 682-2810
 ROCHESTER, MI 48063 (Detroit Area), P. O. Box 508, (313) 651-2545

THE ELKS MAGAZINE, Circulation Dept., 425 Diversey Parkway, Chicago, IL 60614

MEMBERS: Changes of address should be made through your lodge Secretary. Give him advance notice of at least 30 days. Remember that the day you write, your next copy is already in the mails. Before you move, file your new address at the post office to have mail forwarded. In writing to us regarding an address change, please give: Full name, lodge number, membership number, address to which copy is being mailed, and complete new address. Attach label from recent issue if available. Please show ZIP Code numbers in both old and new address.

THE ELKS MAGAZINE, Volume 58, No. 6, November, 1979 (ISSN 0013-6263). Published monthly at 425 W. Diversey Pkwy., Chicago, IL 60614 by the Benevolent and Protective Order of Elks of the United States of America. Second class postage paid at Chicago, IL, and at additional mailing office. Acceptance for mailing at special rate of postage provided for in Section 1103, Act of October 3, 1917, authorized May 20, 1922. Single copy price is 25 cents. Subscription price in the United States and its Possessions, for Elks, \$1.25 a year, for non-Elks, \$2.50 a year; for Canadian and Foreign postage, add \$1.50 a year. Subscriptions are payable in advance. Manuscripts must be typewritten and accompanied by sufficient postage for their return via first class mail. They will be handled with care but this magazine assumes no responsibility for their safety.

The word, **Elks**, is a registered trademark of The Benevolent and Protective Order of Elks of the United States of America. Copyright, 1979, by the Benevolent and Protective Order of Elks of the United States of America

Raise as much money as you need!

**Sell a Pen-Pac for \$1
Keep 50¢ PROFIT!**

Make Big Profits for your school, church, team or civic organization. Here's the easiest fund-raising program around:

- Full 50% profit!
- Free step-by-step manual for fund raising leader!
- No call backs, no order taking no paperwork!
- Nothing to spoil!
- No heavy bulky packages to carry!
- No hidden costs — we even pay postage!
- NO RISK — Pay only after your fund raising drive is over AND return any leftover Pen-Pacs for full credit!

Pen-Pacs are a real value!

5 high quality ball-point pens with long-lasting ink supplies and effective ink erasers make up a Pen-Pac. Outside, its handsome blue & white design states, "Thank You for your generous help." It would sell for \$1.95 in any store. You sell a Pen-Pac for \$1.00 and keep 50¢ profit. Since everyone needs and uses pens, your funds really add up fast!

You Don't Risk a CENT!

There is no risk because you don't have to invest a penny. You have a full 60 days after you receive your Pen-Pacs before payment is due. That gives you plenty of time to complete your drive before you owe us a penny. And you can return any leftover Pen-Pacs at our expense. There are no hidden charges or extra costs. Ever.



**Full
50%
Profit**

...and we ship free

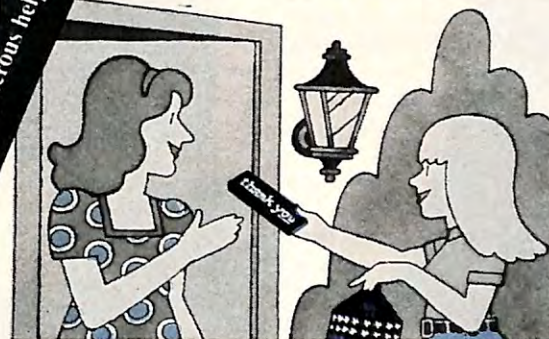

Friends and neighbors will gladly buy

Everything You Need is Included!

25 Pen-Pacs come packaged in a lightweight carrying carton. Order 1 carton per member. Also included are contribution envelopes, a "how-to" manual, record-keeping forms, even press releases...all designed to guarantee your success.



**Call Toll Free
800-631-1068**

Monday through Saturday
from anywhere in the continental U.S.A.

In New Jersey call collect 201-227-7920
In Canada call 1-800-268-5534

CALL TODAY or MAIL THIS COUPON now!

There are 25 Pen Pacs to each carry carton. Order at least one carton per member.

We need to raise: \$100 \$200 \$300 \$500 \$ _____

Please send Pen Pacs 200 400 600 1000 We'll send the quantity you need.

Ship to:

Your name _____ Organization _____

Street address _____ Your title _____ (Age if under 21)

City _____ State _____ Zip _____

The above shipping address is a School Church Business Home Apartment

Area code () _____ Area code () _____

Home telephone number _____ Other telephone number where you can be reached, _____

Our drive will start _____ Number of members _____

(X) Sign Here Before I order, please send more information.

U.S. PEN COMPANY
A subsidiary of Cadence Industries Corporation
Dept. FR646, W. Caldwell, N.J. 07006

All orders will be confirmed by telephone

Our 59th Year

2APP07
© 1979 U.S. Pen Company

WADY TUCK



by Jean E. Laird

What is it that makes a person lucky or unlucky? How much of our luck do we actually create ourselves? A well-known, successful businessman is repeatedly told, "My, you are lucky. Everything you touch seems to turn out well."

He usually answers, "The funny thing about it is, the harder I work, the luckier I seem to get." Is he being cynical? Doesn't "Lady Luck" really have anything to do with success?

Science today is finding out some amazing things about "Lady Luck." Is bad luck caused by the same things that make a person accident-prone? Do some people actually court bad luck? Do poor judgment and bad luck go hand-in-hand? Does a person's luck tend to mirror his attitude and general outlook on life? Is there such a thing as a "run of luck?" Does your ability to communicate, as well as your mental attitude, determine whether you will be lucky or unlucky?

Actually, what is luck? Robert Lyle, who, at the age of 24, had turned a \$1,500 family grant and a few small loans into a \$1 million profit in the stock market, says he is not so sure

what "luck" really means any more. He says, "In high school, I knew a winner was the guy who got a B without trying, had the fastest Chevy in town and scored with the cheerleader. Well, I'm getting all A's now, I'm happily married and I've got the fastest Bentley in town. But, I'm not so sure that constitutes a winner anymore."

Psychological studies show that *chance* really has very little to do with determining how lucky or unlucky we are. However, luck is frequently referred to as a kind of "sixth sense" or intuition—which all of us possess in varying degrees.

Psychologists know that this "sixth sense" or intuition cannot operate at its peak if your conscious mind is all tied up in knots. Recent tests at Duke University indicate that although intuition is innate in all of us, the extent to which it functions depends wholly on a person's mental attitude. These tests showed that mental states which produce tension, such as worry, anxiety, fear, self-doubt, paralyze intuition. On the other hand, when we are calm and self-confident, that delicate sixth sense functions at peak efficiency.

These same psychological studies also indicate that a person's "luck"—the good or bad fortune which comes to him—is influenced to a very large extent by his state of mind. The ancient Chinese had a saying for it—as they seem to have had a saying for almost everything: "Throw a lucky man into the sea and he will come out with a fish in his mouth."

Tests show a negative attitude attracts bad luck, and a pessimistic outlook cuts down your chances for succeeding in anything you try. At Harvard University, a series of experiments were performed with the subject being assigned to specific tasks. Half of the subjects were told the odds were against their completing the job successfully. Psychologists told the other half that they would most likely succeed.

Those with the negative attitude appeared to have slower reflexes and dull perception, causing them to misjudge situations and overlook opportunities to succeed at the experiment. The report says those who expected to do poorly, "took steps to make errors or oversights designed to reaffirm this negative performance expectancy." In effect, they were saying, "You see, I didn't think I would be able to do it—and I was right."

Positive attitude versus "luck" is also

depicted in the following happening. When Charles Lindberg completed his first transatlantic flight, a newspaperman in Paris called out, "Did you ever have any doubts that you might not be lucky enough to reach Europe?" Lindberg grinned and answered, "Do you think I would have started if I thought I might make it only part way?"

By the same token, "You are only lucky enough to win if you aren't afraid to lose," says Rocky Aoki, founder of the Benihana of Tokyo Restaurant chain. Aoki should know. He lost \$250,000 on two Broadway plays and almost \$1 million on a private club in New York. But he was willing to take a chance—just as he had taken a chance at the age of 24, when he opened his first Benihana. He now has 22, and it isn't unusual for them to make \$16 million per year.

Max Gunther says, "If you spend a lot of time fretting about what possible misfortunes may occur and worry about the future as though it won't be anything but a time filled with death, accidents, poverty and other such unpleasant events, why not look at the other side of the coin and realize that good luck is just as possible as bad luck." He adds, "Sure, you could get sick tomorrow, or fall and break your leg, but the odds are equally high that you could be visited by some unexpected stroke of good fortune. Thus, 'unworrying' makes as much sense, statistically speaking, as does worrying. What's more, unworrying is a lot more fun. Since you can't know what will happen to you tomorrow, you might as well contemplate the possibilities with a grin instead of a shudder."

Assuming that bad luck is caused by one's frame of mind, is this the same factor which makes a person accident-prone? Dr. Sandor S. Feldman, who has made a clinical study of self-created luck at the University of Rochester Medical Center, says, "When a non-neurotic person takes a shower and the soap slips from his hand, he will calmly retrieve it. When this happens to a person who has convinced himself that he is unlucky, he becomes agitated and thrashes around, which only makes it more difficult to retrieve the soap, and perhaps causes him to slip and hurt himself in the process." Thus, he creates his own bad luck.

And research at the University of Kentucky shows that there is a marked tendency for "unlucky" things to hap-

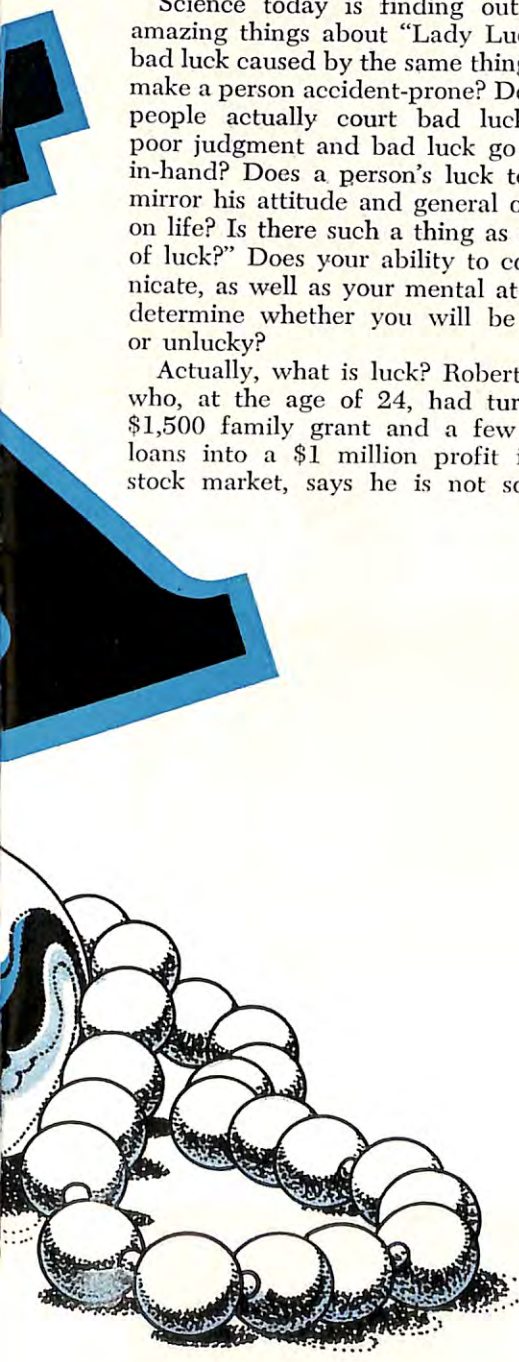

Lady Luck

pen to people who are not happy with themselves. Psychiatrist Karl Menninger has shown that accident-proneness results from a state of mind which reflects the unconscious wish to inflict self-punishment to ease a sense of guilt arising from some real or fancied transgression. He may slam his finger in a door, bump his shin or suffer other mishaps in an effort to subconsciously reconcile with his conscience.

An example is the case of Ben Jamison, an employee in a large grocery store. Jamison slipped on a newly waxed floor and broke his ankle. Six months later, he pulled a muscle in his back while lifting a carton. A few months after that, he cut himself severely on the broken glass on top of a freezer compartment. Less than two months later, he was back in the first aid office for treatment of a severe arm laceration when he walked into an open storage locker door in the furnace room.

After this last trip, Jamison was interviewed by a company psychiatrist who made routine visits to the various stores in the large food chain. It took only a few sessions to pinpoint the cause of his repeated accidents. An extremely quiet man, Jamison was married to a

very dominant woman. Before the most recent accident, he had had a breakfast table argument with his wife and came out on the losing end, as usual. Further probing showed that all his accidents had come after similar "scenes."

Jamison's case is by no means isolated. Dr. Karl Menninger, founder of the famed Menninger Clinic in Topeka, Kansas, described an endless list of "purposive accidents"—acts which, upon analysis, turn out to be subconsciously motivated.

As early as 1936, a German psychologist named Karl Harbe proved statistically that a person who has had one accident is more likely to have another than an individual who hasn't had any at all. But it wasn't until the last 20 years that researchers began to probe the problem scientifically, finding that a negative attitude slows your reflexes and dulls your perception.

Does poor judgment have any effect on your luck? Yes, according to the experts. A woman may try to carry two shopping bags at once to save an extra trip from the car to the kitchen. However, she is likely to drop one and, while attempting to retrieve some of the items, drop several more. She will probably decide that inanimate things just have a grudge against her, when the

entire episode was simply a case of poor judgment.

In the same manner, the experts tell us carelessness and bad luck go hand-in-hand. For instance, real estate swindles flourish today because unwary buyers are too careless to check into the property they are buying. They don't even bother to look at some of the land they buy! By means of attractive brochures sent through the mails, in addition to newspaper advertisements, unscrupulous promoters peddle nearly worthless land and hold it forth as suitable for homesites, retirement or investment purposes. The inducement to buy is usually the low price. Buyers are seldom near enough to the property to be personally able to inspect it carefully, without spending more for transportation than the price of the land warrants. This is all part of the scheme.

We are told about promoters in California who sold worthless building lots in the desert for a total of \$3 million before any victim realized the enormity of the swindle.

If good luck is a self-generated syndrome, how much of our luck do we actually create ourselves? For instance, do personal characteristics enable both men and women to be lucky in the stock market?

(Continued on page 32)

ELKS NATIONAL SERVICE COMMISSION

"So long as there is a disabled veteran in our hospitals, the Benevolent and Protective Order of Elks will never forget him."



A total of 28,000 pounds of paper was collected during San Mateo, CA, Lodge's paper drive recently. Committeemen (from left) Andy Stevenson, Al Celas, Jim Reilley, Herman Hansen, and Chm. Quint Bravo loaded the paper onto the truck. The proceeds from the drive were donated to local hospitalized veterans for the purchase of canteen checkbooks and to allow them to make free phone calls.

T-shirts were presented to disabled vets from Castle Point Veterans Hospital by Brothers of Monticello, NY, Lodge recently. Twenty-seven vets were treated to lunch and dinner when they visited the lodge. Entertainment for the occasion was provided by the Chicken Lips Band. ER Ambrose Yelovich and Chm. Leo Freaney welcomed the guests.



Over 1,500 square feet of cow, deer, and elk hide was presented to the Seattle VA Medical Center by the hide committees of the Washington State Elks Association. The material will be used in the center's therapy program. On hand for the contribution were (from left) Israel Rosen, chief of volunteer services, Earl Sheppard and PER Dale Orff, VAVS representatives, Assistant Director Joseph Jenkins, and Occupational Therapists Chas Frohning, Cleo Mola, and Irene Nichols.



Genuine Antique Clocks

for less than you'd pay
for a mere
replica!



**The Round-Top
Schoolhouse Clock**
\$120.00

(Approx. 22"H. 13"W. 4½"D.)

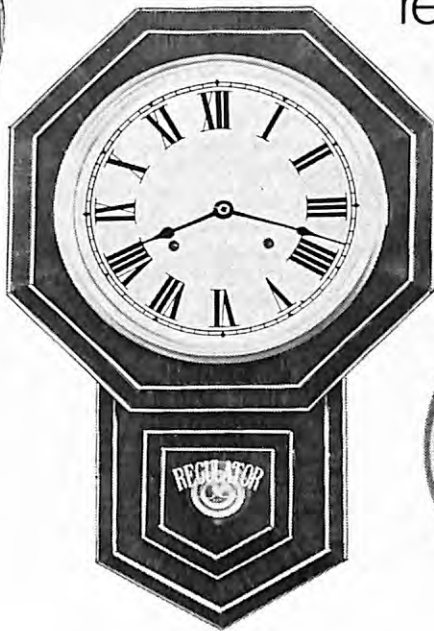

**The Large
Schoolhouse Clock**
\$135.00

(Approx. 24"H. 13¼"W. 4"D.)

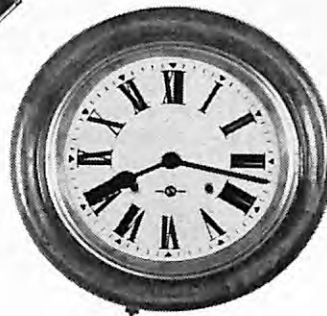

**The
Railroad Station
Gallery Clock**
\$105.00

(Approx. 14" diam., 4½"D.)



**The Ring Octagon
Schoolhouse Clock**
\$120.00

(Approx. 22"H. 13"W. 4½"D.)

We urge you to take heed while you still have the chance to obtain one of these *genuine* Antique Clocks at low, low prices you may never see again. Yes, at prices less than you'd pay for mere reproductions. Our clocks are authentic circa 1900 antique schoolroom clocks, the kind that once ticked happily away in the schoolrooms, legal offices, railroad stations, pubs, front parlours, general stores of America's childhood. Lovingly restored and in 100% running order. Each is unique—yours will be numbered, registered to your family or whomever you designate and accompanied by a handsome Certificate of Age and Ownership (suitable for framing).

these are
Circa 1900 antiques.
When they're gone,
they're gone
forever!

- Certificate of age, authenticity and ownership.
- Fully re-conditioned 8-day keywind movement, brass pendulum, key. Counts each hour in deep, melodic tones.
- Finely polished and carefully restored hardwood case. (Clocks will vary slightly in trim and wood tone.)
- Sturdily cartoned and shipped to you UPS insured. Order now to avoid disappointment. When these clock are gone, they're gone forever.

SAVE GAS AND TIME! Use our Telephone Hot line call (914)-248-7031 9 A.M. to 5 P.M. (E.S.T.) ... and shop at home with your Credit Card!

----- Visit our Showroom, just 1 hour from N.Y.C. -----



Pony Express System 2986 Navajo St., Dept. M-1120, Yorktown, N.Y. 10598

Gentlemen: Please send me the following clock(s) (state qty.):

- _____ The Round-Top Schoolhouse Clock (Style 14) @ \$120.00
 _____ The Large Schoolhouse Clock (Style 21) @ \$135.00
 _____ The Railroad Station Gallery Clock (Style 17) @ \$105.00
 _____ The Ring Octagon Schoolhouse Clock (Style 13) @ \$120.00

(Add \$8.50 for each insured delivery.)

Choice of Arabic or Roman Numerals.

If these clocks are to be Gift orders, please attach a separate sheet of paper stating the name the clock is to be registered to, and name and address for shipment. We will enclose a gift card at your request. On multiple orders, be sure to specify who gets which clock.

My check is enclosed for \$_____ (N.Y. State residents add 5% tax.)

I prefer to charge my (check one)

American Express Bank Americard Master Charge

Account No. _____ Expiration Date _____

Signature _____

Mr./Ms. _____

Address _____

City _____ State _____ Zip _____

Satisfaction Guaranteed

Planer Molder Saw

3 Power TOOLS in 1
Feed



Now you can use this ONE power-feed shop to turn rough lumber into moldings, trim, flooring, furniture—ALL popular patterns. RIP-PLANE-MOLD . . . separately or all at once with a single motor. Low Cost . . . You can own this power tool for only \$50 down.

30-Day FREE Trial! SEND FOR
NO OBLIGATION—NO SALESMAN WILL CALL
RUSH COUPON BELSAW POWER TOOLS CO.
TODAY! 9072 Field Bldg.
Kansas City, Mo. 64111

BELSAW POWER TOOLS
9072 Field Bldg., Kansas City, Mo. 64111

YES Please send me complete facts about
PLANER—MOLDER—SAW and
details about 30-day trial offer.

Name _____
Address _____
City _____
State _____ Zip _____

GREAT ELK GIFTS
Elk styled gifts, all unconditionally guaranteed. Watch band & bolo tie available in silver or gold plate.
Watch band \$21.95 Bolo tie \$14.95
Price includes shipping and handling. Please allow 3 weeks delivery from order date. When ordering, specify gold or silver. BankAmericard Visa Master Charge
Fill in card numbers and expiration date below. Date _____

Mail to J&L Ent., P.O. Box 486, Mtb., CA 90640 (213) 724-6407

ELKS RITUAL CLOCKS
No initiation or lodge ceremony is truly complete without our Emblem Model (as shown) or a Custom Ritual Clock. A Portable Model suitable for funeral services is also available. Optional features may be selected. Over 40 years of satisfied customers.
11th HOUR MFG. CO.
P.O. Box 3100
Aurora, Ill. 60505
312-851-7353

WANTED
Old Saloon Bars and Back Bars.
Stained Glass Windows.
Top Prices Paid.
Send description, Price, Photos, To:
SHEFFIELD'S
5977 Delmar, Saint Louis, MO 63112
OR CALL: 314-727-2411

IT'S YOUR BUSINESS

by John C. Behrens

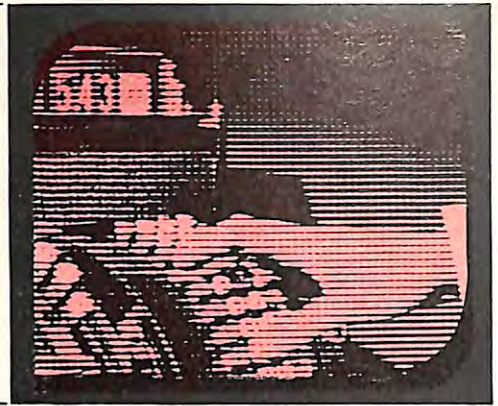

THE DIFFICULT SCHOOL-AGE WORKER, Part I

The young salesperson was idly talking with a customer while I waited. The conversation would have made me bristle if I owned the place. Yet, it wasn't the first time I've overheard employees, young and old, openly criticize their employer in front of customers.

"He thinks I'm really interested, but I could care less about selling these things. It's a living for now, until I find what I really want to do . . . I really don't know why you're buying this . . . I wouldn't!"

As several more customers joined me in line, the young lady behind the counter finished ringing up the sale, scooped up my money and mechanically fingered the register without looking at me. She pitched the change back on the counter without a glance and continued talking to her friend as I walked away. "There's nothing here I would pay for . . . strictly ripoff stuff," I heard her say.

Shocking disloyalty? To me it is. It reflects badly on the person, the store and an owner who would keep someone on the payroll with such an attitude. The problem is that many proprietors and businesspeople face such discontent. A growing amount of it, furthermore, seems to emanate from the young worker.

Do a growing number of youngsters take the line from a popular rock hit—"go on, take the money and run"—as the best course of action when they enter the labor force? More importantly, what are employers doing about such attitudes?

This is the first of two columns which will examine the difficulties that proprietors and small business owners are encountering with some young employees. In part two, we'll look at the methods and suggestions of employers and behavior scientists who believe such problems can be alleviated, if not eradicated, in years ahead.

"Is it really that serious?" a business acquaintance asked me recently. He's hired a number of high school and college students for after-school and evening work, and he's been pleased with most. "I've had super people," he adds. Others echo his comments—an indication, certainly, that the majority of working school-age youth should get our praise and support.

But other businessmen contend they haven't been so fortunate. One veteran and respected businessman told me he's hired high school and college young-

sters for years, but he won't anymore. "The jobs haven't changed; you've got to think while you're working. The kids I've hired in recent times just don't want to do either," he complains.

The problem, furthermore, isn't isolated in any region of the country. Earlier this year, an Associated Press dispatch from Boulder, CO, described the dilemma that employers in that western city were having with younger workers. A survey by the Denver Post discovered that proprietors in the Boulder area found that the under-30 worker to be woefully short on talent and reliability. A contractor told interviewers that he dropped his construction business because of his frustration with the work habits (or lack of them) of his crews. A restaurant owner reported that he loses approximately \$700 a month in broken dishes and mangled silverware because of careless young waiters and waitresses and kitchen help. Another restaurateur faces a more serious matter. "You have to lock up everything because employees steal food and liquor."

But the small enterprises aren't the only ones to suffer from indifferent and negligent workers. Ask the college work-study administrator about the valuable time consumed trying to find jobs for students who simply don't want to work.

"The problem, I find, is that kids nowadays know they need jobs to buy extras. They want things we only dreamed about years ago. This is especially true of kids from so-called better families. But the term 'work' is really meaningless to them. They believe that once they've got the job, they don't have to think, show up on time or even follow simple instructions. Yet, they still want to be paid promptly, and they sure don't hesitate to tell you what they want," said one employer.

Experts aren't really sure what's caused the shift in attitude. Most agree, however, there has been a definite change in recent years. Some lay the blame on societal problems that have come about since World War II. More and more youngsters, called the "me now generation" today, want luxuries—new cars, quality stereo units, trips overseas, fabulous apartments, fashionable clothing—and they need far more money than most parents can afford or will provide in weekly allowances. The natural answer for most

(Continued on page 14)

How to Profit From Our Continuing Inflation in Real Estate

Isn't it about time you personally took steps to cope with inflation and use it to **create** wealth for you instead of standing by helplessly while it drains your paycheck?

by Mark O. Haroldsen

Specifically What You Can Do

I'm not going to bore you with a lot of words or claims to sell you something. I want you to know right away, something you can do to profit substantially from inflation.

It's so basic and easy to do, that many investment analysts and professional consultants overlook it. It is simply this: Go out and buy a second house. It's really quite simple to do.

You're probably thinking, "What do you mean, buy a second house? I'm having enough trouble hanging on to the one I have!" I'll show you exactly how it's done and how you can do it, as I have done it many, many times, even if you don't have any extra money. People, like you, are doing it every day.

Why A Second House?

If you own a home now, you already know what inflation is doing for you. Buying a second house is one of the best ways you can profit from inflation. Why? Because of the tremendous advantages of owning property. It not only rapidly and dramatically increases your net worth because of inflation, but it produces extra income as well while actually decreasing the amount of income taxes you pay on your regular income.

Do It Now

I strongly recommend you buy at least one extra home or income property immediately, so inflation can begin to act upon the property. Get a renter to do all of the following for you: make the payments, pay the interest, taxes, insurance, and the upkeep. By increasing the rent, you'll even have money left over each month. This is usually tax-free extra income each month.

What Inflation Will Do For You

Last year houses went up in value by more than 12% on the national average.

When you buy that property with the lowest down payment possible, that 12% increase can actually increase your wealth by 40 to 50% per year, and even as high as 100%. I'm not throwing these numbers around wildly, I know what I'm talking about, because I've done it! My success in doing this, along with the accomplishments of many others, has been reported and written up in many of the country's leading newspapers and magazines.

What If Inflation Stops?

If you'll really think about it, inflation is a built-in part of our economy. It's been with us a long time and always will be. The **rate** of inflation is what politicians and business leaders are trying to control. Why not concentrate on making inflation, whatever the rate, your friend instead of your foe?

Step-By-Step

I have written down my formula that is based on my own experience, in a volume called "**How to Wake Up the Financial Genius Inside You.**" This volume is concise, easy to read, and will show you step-by-step how to do the following:

- How to buy income properties for very little or no money down
- How you can easily start in your spare time
- Why there are still bargains to be bought today
- How to find a bargain, and if you can't find one, how you can negotiate one
- How a young couple can easily buy their first and second home
- Put cash in your pocket each time you buy (without selling any property)
- Double your profits every year
- Get huge profits out of run-down properties
- The key to financing properties without going to regular lending institutions
- Legally avoid State and Federal Income Taxes, almost indefinitely
- Turn a mortgage into a tax shelter

You see, I can show you all this and show you specifically step-by-step how to do everything I've talked about, because I have actually done it all myself.

And more importantly, I am practicing what I am preaching to you this very day.

Many Others Have Done It

Let me make one thing very clear. I am not the only person that has made a fortune doing what I'm talking to you about. You probably know many people within your own town, maybe even in your own family, who are rich because of real estate.

Here are comments from a few people from around the country that have followed my formula:

- *"Your materials cost me \$19.50. From their contents I will receive a net profit within the next 18 months of about \$125,000. . . ."*
— Gary Weaver, San Gabriel, Calif.
- *"I am 27 years old, married, with one son. We have wanted a nice home for several years, but we never could seem to get out of debt, much less save up a down payment on a new house. The very day I got your book, I read it from cover to cover. Later that afternoon, I used an idea I got from your book to buy the house we had been wanting. It is a beautiful house, complete with a heated pool and all the works. The idea was so simple that I couldn't believe how well it worked. . . . I firmly believe that in a few years, I too will be worth at least \$1,000,000."*
— Emmett G. Godfrey, Bessemer, Alabama
- *"As a result of just looking around and talking to realtors I found my first house (a roughly divided duplex) at a bargain. The owner was willing to finance about 85% at 8% interest. Before I could even close I had several people call wanting to rent. I have a good positive cash flow (about \$80 over the note) and am looking for other properties and ways to finance. I suppose I knew it was possible to make this type of investment; I even had a vague idea about the tax advantages. But I just didn't realize how easy it could be until I read your book."*
— Michael E. Burford, Mississippi

If you're like most people, you're probably skeptical, especially when I'm going to ask you to make a check out for \$10.00 (\$9.50 less than Gary Weaver paid) and send it to me and receive your own copy of "**How to Wake Up the Financial Genius Inside You.**" I really don't blame you for your skepticism, because of the many people in



Mark O. Haroldsen spent four years perfecting a "wealth formula" that harnesses runaway inflation and became a millionaire in the process. More than 400,000 people have discovered how his method can lead them to total Financial Freedom.

this world trying to deceive others.

It's Guaranteed

I hope to overcome your skepticism by guaranteeing that you'll be satisfied that the \$10.00 you'll spend will give you a complete game-plan and the knowledge you need to overcome the effects of inflation, and put it to work for you, instead of against you.

To Back Up This Guarantee

To back up this satisfaction guarantee, I would like you to postdate your check and circle the postdate. I will not be able to cash or deposit your check until you have had (for at least those 30 days) a chance to look at the material I sent you. If for any reason you are not satisfied with my material, send it back and I will promptly return your own uncashed check or money order.

Your Own Financial Freedom

FIRST — I know anyone who wants to be financially independent today, **can be** if they follow the right game-plan, and I have developed a proven game-plan that has worked for me and many thousands of others. SECONDLY — I will live to the letter and spirit of my guarantee, so don't lose by procrastinating. Do something today. Start by ordering my material. Begin NOW to "capitalize" on inflation instead of being hurt by it.

If you send your order to me within 30 days of the date of this publication, I will also include additional material showing you how you can borrow from \$20,000 to \$200,000 at 2% above prime rate, using just your signature as collateral. To order "**HOW TO WAKE UP THE FINANCIAL GENIUS INSIDE YOU**", send \$10.00, check or money order to me, Mark O. Haroldsen, Inc. Dept. AA-174, Market Place Park, 2612 South 1030 West, Salt Lake City, Utah 84119.

IF-1 © Mark O. Haroldsen, Inc. 1979

Will Rogers Remembered

This year, the centennial of the birth of a great American and a great Elk, Will Rogers, is being observed. William Penn Adair Rogers was born November 4, 1879, in Indian Territory, Oklahoma. This is now Rogers County. (It was named after his father, Judge Rogers.)

Will was to become a noted entertainer, the nation's best-loved humorist, author, movie star, newspaper columnist and broadcaster. He loved to fly, and this proved to be his undoing. He met an untimely death in a plane crash in Alaska, along with his pilot, Wiley Post, on August 15, 1935.

Heading the nationwide centennial is actor Joel McCrea; and the Committee includes Bob Hope, Will Rogers, Jr., editor Gilbert Grosvenor and actor James Whitmore.

A special observance is also being scheduled at the Will Rogers Memorial on November 2-3-4. Claremore Lodge No. 1230 has invited the Grand Exalted Ruler and other Grand Lodge dignitaries to be present for the event.

Will Rogers became a member of the Benevolent and Protective Order of Elks in New York Lodge No. 1 on March 13, 1910, only a year or so before the lodge had acquired the property at 108 W. 43rd Street, just off Broadway's Great White Way. (The building has since become the Hotel Diplomat.) To help finance it, initiation fees were raised to \$100.

There was speculation in later years that Brother Rogers had been initiated by New York Lodge No. 1 for "some lodge in Oklahoma." Various members contended that they had "sat" in lodge in Oklahoma with Brother Will. Authentic records, however, disprove this. By coincidence, the Esquire of New York Lodge No. 1, who served during his initiation, was none other than Murray Hulbert, who was to become Grand Exalted Ruler in 1928-29.

Rogers became a life member of New York Lodge No. 1 in 1915; and the teachings of Elkdom must have rubbed off on Will, as his life closely paralleled the cardinal virtues of the Order.

At the time, Brother "Bill," as he was known to his friends, became an Elk, it was customary for the members to do their good deeds in silence. They "hid their light under a bushel." It wasn't until World War II that this attitude

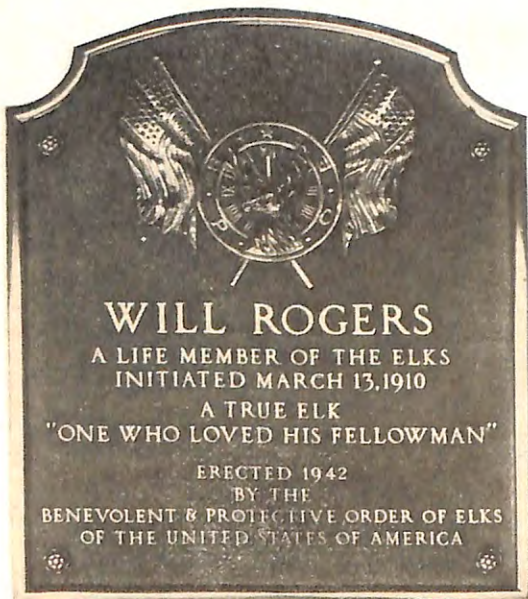

Shortly before his death in 1935, Will Rogers appeared in the movie, "Life Begins at Forty" (right). Will's disarming country mannerisms (next right) belied an uncanny ability to find the truth in the most complicated issues of the times. He launched his vaudeville career in 1905 (far right), saying, "swinging a rope is all right—when your neck ain't in it." The Elks presented a plaque (above) to the Will Rogers Memorial Museum in 1942.



began to change and the Order sought publicity for the generous things they were doing to help their fellowman. Brother Rogers appears to have followed the philosophy of giving in silence, and frequently told recipients of his generosity to "keep it quiet."

To Will Rogers, according to biographers, the greatest word in life was "Charity" (the cornerstone of every Elk structure). Two of his favorite charities were The Salvation Army and The Red Cross. Again, this parallels Elkdom. During World War I, the Elks contributed heavily to The Salvation Army activities. So did Will Rogers.

At the Grand Lodge session of 1919 in Atlantic City, Commander Evangeline Booth of The Salvation Army made an unprecedented appearance to pay tribute to the Order for its support of the Army's relief work during the war on the battlefields of France.

The work of The Red Cross has always been supported generously by the individual lodges. Brother Rogers donated one-tenth of his income to The Red Cross for the duration of World War I. Will, as did all Elks, contributed to the Elks War Relief Fund during World War I when nearly \$1 million was raised.

It has been traditional at Christmas for Elks to provide toys, baskets of food

and other necessities to the needy, as well as to make a special effort to entertain children. Will Rogers, in all probability, responded in similar fashion. Biographers say that he could not resist a benefit. The record shows, for instance, that during Christmas week in 1934, he appeared at dozens of functions for the needy in the Hollywood and Los Angeles area.

Following Will Rogers' death, the city of Santa Monica, California, held a special observance in his memory. Participating greatly in this was Santa Monica Lodge No. 906. The lodge provided a special float with Will Rogers' picture superimposed over a clock, stopped at the hour of 11. It was inscribed, "To Our Absent Brother." The lodge officers provided the honor guard and state association officers appeared in the cavalcade.

Elk members, by the way, headed the committee for the observance, and the lodge conducted an essay contest.

The Elks National Foundation Trustees, in announcing the scholarship awards for 1935-36, sought to honor Brother Rogers. They made, "Will Rogers—His Place and Influence in American Life," the theme of the essays to be submitted for awards.

In making the announcement, the Trustees said, in part: "In recognition

of Will Rogers' remarkable rise from humble circumstances to world renown, of his contributions to pleasant living by his delightful humor and his keen epitomes of men and events, and in appreciation of the high esteem in which he was held by all types and classes of his fellowmen . . . the Elks National Foundation is proud to make this announcement . . ."

Will Rogers was a true American, and an Elk, in the finest sense because he exemplified the principles of the Order through his philanthropies. His philosophy of, "I never met a man I did not like," contains the whole gospel of Brotherly Love.

It is little wonder then, that on January 18, 1942, when Judge John S. McClelland was Grand Exalted Ruler, the Order of Elks presented a bronze plaque to the Will Rogers Memorial Museum in Claremore, Oklahoma, which reads in part: "Will Rogers . . . a true Elk, one who loved his fellowman."

Our thanks to Brother Sam Fitzsimmons, Van Wert, OH, Grand Lodge Americanism Committee, for his research, and to Dr. Reba Collins, Curator of the Will Rogers Memorial, Claremore, OK, for the loan of these Will Rogers photographs. ■



Brooks Brothers

The Classic Button-Down Oxford Shirt

Our Mr. John Brooks Introduced It In 1900.
Others Have Tried To Imitate It. In Vain.



When Mr. John Brooks, in 1900, appropriated the "polo collar" from British polo players, he created the shirt that perhaps best epitomizes our craftsmanship... and is possibly the world's most imitated shirt. In 80 years, nobody has ever captured the spirit of its single-needle tailoring, its unique Brooks full-roll collar, and its generously cut body. Tailored in long staple Pima cotton oxford, woven only for us, it retains its fresh look all day. In blue, white, pink, yellow, ecru, stone, peach. Collar sizes 14½-17; sleeves 32-36. \$21.50

Name _____
Address _____
City _____
State _____ Zip _____

Oxford Button-Down Shirt @ \$21.50 **K301**

Quantity	Color	Collar Size	Sleeve Length

Charge to: Brooks Brothers VISA
 Am. Ex. MC

Account # _____

Exp. Date _____

Signature _____

Credit Card Customers Call Toll Free 800-648-5600.

Send FREE 1979 Brooks Brothers catalog.

Enclosed is check money order for \$_____. Add applicable tax and \$1.75 for shipping and handling.

BROOKS BROTHERS, Dept. E1000, 346 Madison Ave., New York, N.Y. 10017

It's Your Business

(Continued from page 10)

teenagers is to get a job. But far too many have never worked—day after day, week after week, that is—before.

Fueling this glut of young people in the labor market are growing numbers of businessmen trying to keep inflationary costs down by hiring less expensive personnel.

Immature young people are damaging their own employment prospects, however, by jumping from job to job, depending upon whims and changing needs. Frustrated employers have told me that it's not uncommon for young employees to work enough days to buy something they want and then quit without a reason or advance notice. Others, I'm told, will take days off without calling in, use company vehicles for unauthorized deliveries and purposes, damage merchandise without thinking, continually take more time than allotted other employees for lunch, and spend too much time on the telephone, unless constantly supervised.

Perhaps all of us are guilty of deceiving youngsters about the American work ethic. A parent decides to take a nice day or two off and calls in sick in front of the kids. I've heard parents boast about how they showed a teenage son or daughter how to collect twice on an accident claim. Then, of course, there's the parent who uses the company car and gas for everything but company business, and lets his offspring know the secrets of conning the corporation.

The bottom line, then, has simply become to get all you can, while you can and don't get caught. It certainly isn't new, it's merely become more widespread. What frightens employers is that they are finding more and more middle and upper class youngsters taking part in this national ripoff. It's no wonder productivity is slipping.

"Ten years ago there were a few students who did work and needed to work," said a Nashville guidance counselor. "But the majority did not work, and the few who would go to the grocery store sacked groceries. Now they do everything."

An educational counselor believes that they work to satisfy an urgent need for independence. "Once they feel they are financially independent, they become insolent and disrespectful. When a student has his own automobile and money in his pocket, it's hard to tell him anything."

Said an employer in the northeast, who now avoids hiring school-age workers if at all possible: "I have kids of my own and I'm a moderate when it comes to discipline, but I've been shocked in the last few years about the lack of respect I've seen among those who have interviewed for jobs with me. I can't afford the problems they would cause me."

What can be done to improve the attitude of the young employee? How can employers get more effort from the young workers as well? What kind of supervision works best? Next month, we'll discuss these questions and others in part two of "The Difficult School-Age Worker."

Make \$800 An Hour and MORE Sparetime or Fulltime

Sharpen Saws and other tools in Profitable Business of Your Own Be Your Own Boss!!

Turn your spare hours in the evening or weekends into extra dollars, this proven practical way—start your own money-making sharpening business—No selling or canvassing—No experience required.

You quickly learn how to sharpen these valuable tools and many others. Excellent profits! We show you how to set up a business and keep it running profitably. Part time or full time. No special skills needed.



FREE BOOK Send coupon and you'll receive, at no obligation, a booklet that describes in detail, the opportunities available to a person who owns his own saw and tool sharpening business.

There is NO Obligation



MANUFACTURING COMPANY
1836 Foley Building
Minneapolis, Minnesota 55418

Please send me the free booklet "Opportunities In A Sharpening Business Of Your Own."

Name _____
Address _____ Phone _____
City _____ State _____ Zip _____

FOLEY MANUFACTURING CO.
1836 Foley Building
Minneapolis, Minnesota 55418

Send Coupon Today or CALL TOLL FREE 1-800-328-7140

Except Hawaii or Alaska

You say you're fed up with hauling ice?

Read about the electronic portable refrigerator that has made your cooler as obsolete as grandma's kitchen icebox.

Now only \$134.00 during our off-season!

Does your family groan when it's time to empty all that yucky water out of the cooler? Are you getting tired of paying for food that goes bad? When somebody even mentions the word "ice" - do your back and shoulders ache a little?

YOU'VE COME TO THE RIGHT PAGE.

There's good news here: The Aerospace Program has spun off a portable refrigeration breakthrough!

Big Research Discovery

Space scientists at Cape Canaveral had to keep critical components in rockets and satellites cool. They needed something small and light...something that used very little power but was absolutely reliable...something that wouldn't konk out if it were tipped up, down, or sideways. The result? Solid state thermoelectric refrigeration modules that went to the Moon.

Enter Koolatron

Koolatron was quick to see the civilian-use possibilities of these modules for portable refrigeration. They worked until they developed Koolatron - a 12 volt portable electronic refrigerator that uses the same powerful solid state thermoelectric refrigeration modules used in rockets and satellites.

Saves Energy

Koolatron uses very little juice - an average of only two amps when the temperature outside is 70 degrees Fahrenheit. That's less power than it takes to light a 30 watt bulb. Once contents are cold, you can turn it off at night to save power. Contents will stay cool for at least 6 to 12 hours. Your muscle energy is conserved, too. It weighs only 15 pounds - and you'll never have to haul ice again!



Saves Inconvenience

No more driving for miles or heading into shore for ice. Plug it in a lighter socket in your car, boat or van. Or run it off a 12 volt battery charger plugged into 110 volts.

Saves Shopping Trips

Koolatron holds more - so you spend less time shopping. Although it measures no larger than most ice chests, its 36 quart capacity is not half-filled with ice and sloshing water. So there's more room for food - 40 pounds of it, or 48 large cans of soda pop!

Saves Food

This is *dry* cooling we're talking about. Not the *damp* kind that breeds mold and can turn perfectly good food bad overnight -

exposing the whole family to needless risk. Koolatron keeps your food cold and dry. With food prices so high, it's a shame to let any more meat and milk or sandwiches spoil!



SOUND FAMILIAR?... "Mary, where do you want this 50 pounds of ice?" "...Wait George, I'm not through draining the ice chest!" "...Dad-dy - you're dripping more water where I've mopped the floor!" "...Hey, Mom, these tuna salad sandwiches are soaking wet - and (phew!) they smell bad." "...Mary, quick, I'm going to drop this @#!%& ice on my toes!" "...George -!"

No Toy

Koolatron is built to *last*. The rugged case is filled with the best insulation available - rigid urethane foam. Its heavy-duty handle can take loads of 150 pounds or more. Hinges and latches are made of non-rusting polypropylene. The exterior is a handsome harvest gold with a white, easy-to-keep-clean interior. Four non-slip rubber feet keep it from marring boat or camper surfaces.

Saves Money

Ice is expensive these days. So is the gasoline you use in looking for it. Don't waste another dollar this way! Get yourself a new Koolatron 12 volt portable electronic refrigerator and LET IT PAY FOR ITSELF. That's right. The money thrown away on ice and gasoline and spoiled food - not to mention what your own time is worth - will MORE THAN PAY for your new Koolatron in a single year!

Proof: A recent survey of Koolatron owners revealed their *average* saving was \$156.03 in just nine months. Some claimed they had saved over \$500.00 on ice, gasoline, spoiled foods, and the restaurant meals made necessary when the ice ran out.

No Hassle - Ever

Koolatron was designed by engineers who are also boatowners and campers. They know you want something simple that doesn't break down and is easy to service.

Because of Koolatron's solid state construction your unit should never require any servicing unless physically damaged.

If service is ever required, it is available through our service depots in Batavia, NY, or Barrie, Ont., Canada.

So Reliable It's Guaranteed For One Full Year

Your new Koolatron comes with a written one year guarantee plus complete instructions and helpful information. If you need additional help or advice anytime, you can call or write for a personal reply.



The new Koolatron keeps over 40 lbs. of food at household refrigeration temperature but weighs only 15 lbs. Only 21" x 16" x 16" ext.

Model F1A shown.

21 Day Money-Back Trial Period

Use your Koolatron for 21 days after you receive it. If for any reason you are not totally satisfied, return it for a prompt refund in full.

Special Off Season Discount!

The Koolatron F1 has regularly been selling at \$159. (\$179 in Canada). By ordering off-season you can save a full \$25 off these prices. You save! We keep our plant at an efficient operating level off-season! But you must order now.

Adjustable Thermostat Option

For an additional \$10 you can order the Koolatron with an adjustable thermostat in place of the standard fixed temperature thermostat - order model F1A.

Optional 110 Volt Adapter.

This custom-made adaptor lets you operate anywhere on 110 volt power... home, cottage, motel, patio, pool... only \$29.95. (\$34.95 in Canada.)

Ideal Christmas Gift!

Phone your order in collect now to

(705) 737-0842

Or use this handy order coupon.

Koolatron INDUSTRIES LIMITED
 56 Harvester Avenue, Batavia, New York 14020
 Canada: 230 Bayview Drive, Barrie, Ontario
 L4N 4Y8 Dept. 885

Send me - Koolatron F1 @ \$134.00 (\$154.00 in Canada) + \$7 each for handling and delivery in USA or Canada (N.Y., Ont. and Que. residents add sales tax.)

I want model F1A and have added \$10.
 I also want the power adapter and have added \$29.95. (\$34.95 in Canada.)

I understand that if I am not satisfied, I may return it undamaged within 21 days and get a full refund.

I enclose my check money order for \$ _____
 or please charge my Visa Master Charge
 American Express

Acct. No. _____ Expiry date _____

Please send colour brochure only.

Signature _____
 (necessary to ship merchandise)

Name _____

Address _____

City _____

State/Prov _____ Zip/Postal Code _____



The Cadre Noir: France's Brilliant Equestrians

**The Cadre Noir, or Black Squadron,
has often been described as the French equivalent of
Austria's renowned Spanish Riding School.**

by King Harris

The following quotations, while seemingly contradictory, best illustrate the tradition, spirit and history of France's legendary Cadre Noir: "An organization which does not look after its past has no future," and "The cult of tradition does not exclude the love for progress." This elite group of brilliant riders has perpetuated the glory of the French Cavalry, and the squadron's fame has gone far beyond its own nation's borders.

The Cadre Noir, or Black Squadron, has often been called the French equivalent of Austria's renowned Spanish Riding School. I had seen the White Lipizzaner Stallions perform their equestrian ballet in Vienna's old Winter Riding Hall before an enthralled audience. If such brilliant horsemanship existed elsewhere in the world, I wanted to see it. I was not disappointed—although I found there were more differences than similarities between the two famous riding academies.

It is a pleasant, two-hour drive from Paris to Saumur, the home of the Cadre Noir. Located on the left bank of the Loire River, Saumur is a town of tranquil beauty, one of the most beautiful sites in France. The riding school is flanked by the Chardonnet, a large public park, and lies in the shadow of the Saumur Castle, built between the 11th and 13th centuries. The fourteenth century town hall and many other medi-

eval buildings are linked to the castle by ancient winding streets, bravely holding their own against the more modern parts of town. At night, the castle is floodlit and the older natives romantically reminisce about the days when young officers paraded in the streets in search of the beautiful ladies of Saumur, known as the Cadre Rose.

The Cadre Noir is intertwined with France's colorful military and equestrian history. From the 16th century through the 18th century, France set the equitation standards of the world. Louis XIV erected two magnificent stables at Versailles: the Grand and Petites Ecuries. In 1680 he added the celebrated Versailles Riding School, called the Manege. Here, the riding masters were able to establish the principles of their doctrines on equitation and maintain its traditions through the practice and teaching of them, thus passing on their expertise from generation to generation.

The Manege at Versailles was disrupted by the Revolution and the Napoleonic Wars. In 1825, however, the baton of French excellence in equitation was passed to the Cadre Noir at Saumur, where a cavalry school had been founded in 1785. The famed squadron has successfully weathered the changes of time, surviving some of France's most turbulent years: the invasion by Germany in 1871, two world wars, and

military involvement in Indo China and Algeria. Many of the nation's World War II heroes attended the cavalry school at Saumur, such as Generals Leyautrey, Wegand, Leclere, Lattre de Tassigny and Charles deGaulle. And as any member of the Cadre Noir will proudly point out, General George Patton took several courses at Saumur to learn the methods of the French Cavalry and French equestrian techniques.

To distinguish themselves from other military instructors who formed the Cadre Blue, or Blue Squadron, the horsemen of Saumur were called the Cadre Noir, or Black Squadron, because of their traditional uniform—black, with gold stripes and insignia, gold epaulettes, a black and gold riding whip and a two-pointed cocked hat, the kind that was worn during battle and the exclusive headdress of the Cadre Noir. It is truly an exquisite uniform.

General Blacque-Belair, *Ecuyer En Chef* of Saumur in 1909, described the uniform this way: "It has remained one of the most elegant and practical uniforms. It is dark, to give the silhouette a better profile, and black, to give a slimming appearance and keep good posture. Its quality is in its severity and its simplicity."

The public performance of the Cadre Noir is one of the most popular tourist attractions in France. The squadron has performed for heads of state all over

Europe, and offers two presentations to the public at Saumur, on the first and third Friday of each month at 11 a.m. (except in July and August).

Like its counterpart, the Spanish Riding School, both academies are built on generations of tradition and the basic, unwritten doctrines kept alive by the directors of the riding schools, exemplifying the finest horsemanship in the world. Their mounts excel in the "Haute Ecole of Equitation," meaning the ability to execute the most difficult exercises in perfect balance. These classic principles of riding have been popular in Europe for over 400 years. Neither school uses artificial gaits or unnatural movements. Both performances include the crowd pleasing, but extremely difficult, "Airs Above the Ground."

Riders of the Cadre Noir, dressed in traditional black and gold uniforms, display the horsemanship for which the French school of riding is famous. Established at Versailles in 1680 by King Louis XIV, the Black Squadron has continued the tradition of excellence in equitation for three centuries.



Combining sport with art, the French school of riding trains world-class competitors and future riding instructors. At left, below, horses and riders of the Cadre Noir enter the riding hall at Saumur, where bimonthly performances are given for the public. Below is Pierre Durand of the French Equestrian Team.



PRICE BREAK!

The What-In-Hell-Is-It Clock!

A NEW SPENCER FIND!

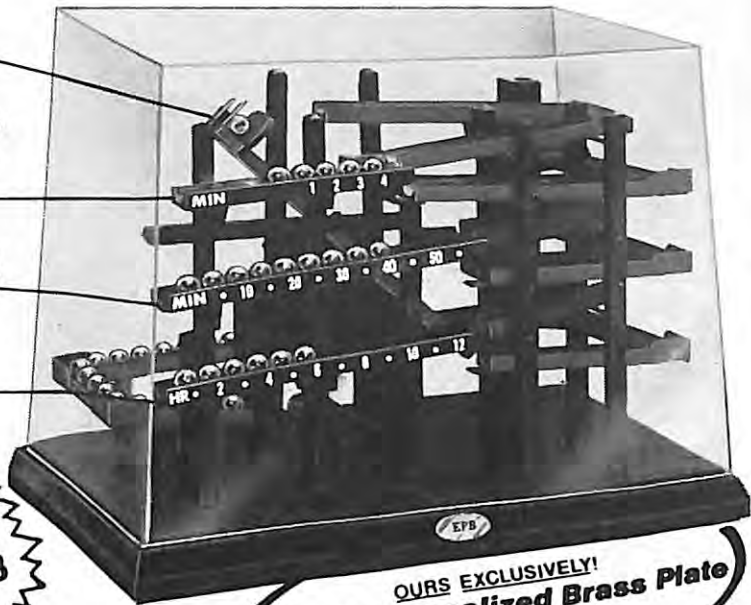
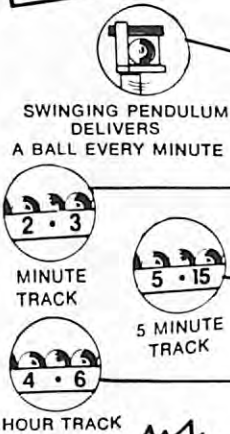

SIMILAR MODELS SELL FOR \$150.00
SALE! PRICE SMASH!
ONLY \$28.88

OURS EXCLUSIVELY!
FREE! Personalized Brass Plate With Your Initials

It has no face and no hands. But this WonderBall Electric Clock tells time with unflinching accuracy to the minute, hour after hour, day after day—year after year. And its unique continuing action is so fascinating to watch you will hardly be able to take your eyes off it!

HOW IT WORKS!

A rotating electric pendulum scoops up one of the 32 steel balls every minute, and starts it in motion down a series of precisely balanced "tracks." Each ball changes the balance of the mechanism, causing the balls to roll from one "track" down to another. And you can instantly read the time in minute, five-minute, and hourly units, by looking at the number of balls stacked on each of the three numbered time tracks.

ACCURATE RELIABLE CLOCK!

It's all utterly absorbing to watch. And your family and friends will find it hard to believe this is really an accurate, reliable clock. But it is—a unique, highly efficient timepiece that never needs re-setting. The rotating pendulum is powered by a precision-made motor. The nickel-plated steel balls roll in scientifically engineered tracks that snap-fit together. To protect your WonderBall Clock, a stylish, see-through dust cover is included. Simple illustrated instructions show you how to assemble your Clock in as little as an hour.

UL LISTED MOTOR!

The WonderBall Clock is 5½" Deep X 9½" High. It is made of rich Jet Black plastic and has a UL listed motor. Just plug it in and let WonderBall do the rest! Order this fascinating, useful timepiece for your home now! \$28.88 (Including personalized brass plate with your initials!)

spencer D-55 Spencer Bldg., Atlantic City, New Jersey 08411
 Bringing You Direct Mail Savings For Over 30 years

CREDIT CARD CUSTOMERS CALL TOLL-FREE 24 HOURS DIAL 1-800-621-5809
 Anywhere in the U.S.
 24 Hours a Day—7 Days a Week... Including Sunday!
IN ILLINOIS—DIAL 1-800-972-5858

15-DAY NO-RISK TRIAL OFFER
Spencer Gifts, Inc., D-55 Spencer Bldg. Atlantic City, N.J. 08411

- Please send me WonderBall Electric Clock P-00612 @ \$28.88 plus \$2.50 postage and handling.
- SAVE \$3.00!** Order TWO for only \$54.76 plus \$5.00 postage and handling. My initials: _____

I understand that if I am not completely satisfied, I may return within 15 days for a complete refund of the purchase price.

Cost of Clock(s) Ordered .. \$ _____
 Add Postage & Handling .. \$ _____
 Add Sales Tax (see chart) .. \$ _____
 I enclose check or, money order for total. \$ _____

Charge to American Express
 BankAmericard/Visa Diners Club
 Master Charge Exp.Date .. _____

Interbank # .. _____
 (Find above your name)

Card # .. _____

Signature .. _____

Print Name .. _____

Address .. _____

City .. _____ State .. _____ Zip .. _____

STATE SALES TAX CHART. Please add to your remittance OK 2%, AR CO GA IA KS LA ND VT 3%, MO 3¼%, NE 3½%, AL AZ FL IL IN MI MN NC NM SC VA WI 4%, OH 4¼%, KY MA MD ME MS NJ SD TX UT 5%, WA 5.2%, CA PA RI TN 6%, CT NY 7%, NYC 8%.

© Spencer Gifts, Inc., 1979



After walking through the stables, talking with the riders and watching several members of the squadron school their horses in the large, tree-lined, outdoor riding arena, the dissimilarities between the Cadre Noir and the Spanish Riding School quickly became evident.

The horses of Saumur are of different sizes, colors and breeds. The Cadre Noir trains the horses bred by the National Stud Administration at their many breeding farms throughout France, including Thoroughbreds, Anglo-Arabs, French saddle horses and mixed breeds.

The Spanish Riding School, however, maintains only one breed, the white Lippizzaners, the descendants of the noble Spanish horses, and the result of centuries of breeding. It was the Lippizzaners who were portrayed in the Walt Disney movie, *The Miracle of the White Stallions*. There is only one breeding farm located in the Styrian Village of Piber. All of the horses are approximately the same size and color, although a brown Lippizzaner is born once in every decade due to genetic laws. The Spanish Riding School traditionally keeps one such stallion as a reminder of the time, many centuries ago, when the breed consisted of horses of many colors.

The Spanish Riding School concentrates on a very pure way of riding, maintaining the riding style of their academy the same as it was done four centuries ago, exclusively toward *Dressage*, maneuvers involving changes of gait, pace, and airs in response to barely perceptible movements of the rider. The Cadre Noir orients equitation as much toward sport as toward pure art by training their horses for use in various sports: jumping, polo, hunting, steeplechasing and cross-country competition. They also, however, excel in *Dressage*, which is the French word for training. *Dressage* is the means to other forms of riding, for it puts the horse in balance and a balanced horse can do anything. This is the dual character of the Cadre Noir—academic equitation allied to outdoor riding.

The precise disciplines practiced at the Manege at Versailles and the Spanish Riding School were broken in 1850 by Count d'Aure, *Ecuyer En Chef* of the Cadre Noir from 1847 to 1857. Count d'Aure taught that the horse was to be used in the field as nature had made
 (Continued on page 30)



• Reading, "Can We Curb Violence in America's Schools?" (August, 1979) by Frank Thistle, I don't understand why our courts and public officials have allowed our society to deteriorate to such a degree. One simple, corrective measure is to bring the "woodshed" back to home and school. Our educational systems could do well to concentrate on the three R's, and to teach self respect.

Howard W. Martin
Montpelier, VT

• Articles such as, "Glaucoma: The Thief of Sight" (July, 1979) by G. R. von Kronenberger, are the reason I always look forward to *The Elks Magazine*. I would be grateful if you would print the address of the National Society for the Prevention of Blindness.

C. William Mortieau
Ennis, MT

Contact: Virginia Boyce, Exec. Dir.,
National Society for the Prevention of
Blindness, 79 Madison Ave., New York,
NY 10016.

• I thoroughly enjoyed, "Suwannee River Fever," (July, 1979) by Bill Thomas. However, just a point of historical interest: when Stephen Foster wrote, "Old Folks at Home," in 1851, he didn't write about the Suwannee River. The original lyrics in Foster's own handwriting are about the Pee Dee River, which runs through North and South Carolina. For some unknown reason, he changed the lyrics by crossing out "Pee Dee" and inserting "Swanee" (misspelling it Suwannee). Admittedly, it makes little difference, because this beautiful, timeless song is really about people, anyway, not rivers. Congratulations on a consistently fine magazine.

John Briscoe
State College, PA

• Robert E. Gilson has been a member of the Elks for years—first in Long Island at Queens Borough (Elmhurst) Lodge No. 878, then in Florida. For the past year, he's been confined to a nursing home. His mind is perfectly clear, but he can't turn over, feed himself, or do anything on his own. He doesn't want anyone feeling sorry for him—and he's a treasure to talk to. Yet, the hours in bed go by very slowly. He has no family, friends are all gone, and he is alone in the world.

Perhaps some Elks will recall Mr. Gilson and would like to write him, or even call. What a joy it would be for him to be remembered. Write: Robert E. Gilson, 2361 Slaterville Rd., Ithica, NY 14850, or call: 607-272-6575.

Bernice Zupamie
Ithica, NY

Letters must be signed and may be edited.
Address to: Letter Editor, *The Elks Magazine*,
425 West Diversey, Chicago, Illinois 60614.



Lower the Thermostat...

DAMART WILL KEEP YOU WARM!

It's 10° outside... Even getting colder. So you bundle up in layers and layers of heavy clothes. First with long underwear... then bulky, restrictive thermalwear on top.

Oh, you were warm all right. Like in a Turkish bath. Because you began to perspire from all your activity. And perspiring in that mountain of clothes is like perspiring in a plastic bag! The perspiration is locked in. So there you are. Wet and miserable.

But now, at last, Damart has solved the problem. Because Damart invented underwear that keeps you warm, dry and comfortable no matter how cold it is or how long you stay out. Underwear that's soft and light so you can move easily. Underwear knitted to let the perspiration evaporate through so you always stay warm and dry next to your skin.

Damart does this with a new miracle fabric—Thermolactyl. No other underwear does this! You can wear Damart indoors too, and turn your thermostat into the 60's. You'll feel perfectly comfortable and enjoy dramatic savings in home heating costs.

Damart will be supplying *The 1980 U.S. Winter Olympic Team* with Thermolactyl underwear! Damart is so comfortable that the Mt. Everest climbing expedition wears it. So does the Chicago



Bears Football Club, New England Patriots and Philadelphia Eagles.

Our free catalog tells the full Damart Thermolactyl story and displays the whole Damart line for men and women, including tall sizes. Send for your FREE copy now!

THE PROOF IS IN THE WEARING

Damart Thermawear, Inc.
WHEN IN THE BOSTON AREA, VISIT OUR
PORTSMOUTH, N.H. STORE. (603) 431-4700



SUPPLIER 1980 U.S.
WINTER OLYMPIC TEAM

THERE IS NO WARMER UNDERWEAR MADE!

Fill out and send to:
DAMART, INC. Dept. 10709
1811 Woodbury Ave.
Portsmouth, N.H. 03805

YES! Rush me your **FREE DAMART** Catalog... I want to enjoy the fantastic warmth of Thermolactyl Underwear, a DAMART® exclusive. (I understand there is no obligation.)



PRINT NAME _____

ADDRESS _____

CITY _____

STATE _____

ZIP _____

© 1979, Damart, Inc.

Let Belsaw prove **YOU** can

Earn Up To
\$800 an
Hour



In
**YOUR
OWN
SPARE
TIME** or
FULLTIME

SHARPENING BUSINESS!

On our
**30-DAY
FREE
TRIAL
OFFER**

You risk nothing by accepting this offer to see how easily you can turn your spare time into big Cash Profits with your own Complete Sharpening Shop. No selling... no previous experience needed. Our famous Sharp-All and show-how instruction set you up to make \$200, \$500, \$700 a month CASH sharpening Saws, Knives, Scissors, Lawnmowers, Shop and Garden Tools... all cutting edges.



FREE BOOK! Send for all the facts! Our Free Book tells how to start a profitable, lifetime home sharpening business, how we help you grow, how we'll finance you.

Send for FREE details—mail coupon below or postcard TODAY!
BELSAW SHARP-ALL CO., 6071 Field Bldg., Kansas City, Mo. 64111

No Obligation... No Salesman Will Call

YES, BELSAW, 6071 Field Bldg., Kansas City, Mo. 64111 please send me the **FREE BOOK** that gives full details.

Name _____ Please Print _____
Address _____
City-State _____ Zip _____

Put Your Fund-Raising Program in the Winner's Circle

CINEMA RACES is a fascinating fund-raising formula used successfully by organizations throughout the U.S.A. The CINEMA RACES complete package includes: Authentic full-color-and-sound 16mm horserace films, programs, tickets, play money and easy-to-follow instructions. CINEMA RACES will make the most rewarding Game Night you've ever sponsored. Call or write for details.

CINEMA RACES
Dept. E9
A General Instrument Company
383 Hillen Rd. / Towson, Md. 21204
301-321-8166



RUPTURE AGONY

DISAPPEARS..... WHEN you slip into a Brooks Appliance! Your reducible rupture will be held firmly, yet gently, night and day, at work or play. Send for our FREE illustrated booklet.
BROOKS CO., Box 370-B, Marshall, Mich. 49068



REMBRANDT DID IT IN OILS...
Let us do it in **BRONZE PLAQUES** FOR ALL OCCASIONS
Write for Free Catalog E23
Engraved Plaques E21
INTERNATIONAL BRONZE TABLET CO., INC.
150 W. 22nd St., N.Y., N.Y. 10011 212-WA 4-2323



YOU AND RETIREMENT

by Grace W. Weinstein



KEEPING FIT

Exercise is one key to a longer and healthier life—but the kind of exercise is critically important. Strenuous and infrequent exertion is frequently more hazardous than a life of no exertion at all. This is true at any age, and is even more true for the over-fifty.

The right kind of exercise, however, tones the muscles, reduces fatigue, improves the cardiovascular system, and contributes to an overall sense of well-being. The right kind of exercise can be almost any form of exercise if it is tailored to your individual needs and capacities.

A new book, *Enjoying the Active Life After Fifty*, by Ralph H. Hopp (Stephen Greene Press, \$5.95), describes 18 outdoor activities, from the most gentle to the most strenuous, with specific guidelines for older people. The first and most basic guideline, however, is this: If you haven't exercised recently and regularly, have a medical examination before you begin any new exercise program. Plan to make your new routine a regular habit; a minimum investment in good health requires 30 minutes of exercise three times a week. Start slowly and build your exercise program gradually. Combine exercise with sensible nutrition.

You won't want to start a brand-new exercise program at the level of vigorous downhill skiing—not unless you build up your strength and endurance first. And you may not want to plan on jogging at all. But you also don't have to stick to calisthenics within your own four walls.

One of the best all-round exercises, at any age, is swimming. Water is buoyant, which helps. Swimming engages the entire body. And swimming is both inexpensive and widely available, at Ys and community centers, as well as lakes and ponds. Perhaps one of the best things about swimming, too, is that it is non-competitive; you can set your own goals—to get back and forth five or ten or twenty times, for instance—and set your own pace. Instruction, if necessary, will help you develop proper technique so that you will get the most out of the exercise. The staff at your local pool can probably arrange lessons.

Tennis and golf are enjoyed by many people of all ages. But what about taking up these sports, for the first time, after fifty? With tennis, a vigorous activity, warmup exercises are especially advised. Doubles are a lot less strenuous than

singles play. Good sense is most important, recognizing that you needn't chase an out-of-reach ball, or play in the heat of the day, or keep playing after you know that you're tired.

Golf can be indulged in on many levels, from riding the fairways in a motorized cart to walking and carrying your own clubs. On an 18-hole course, the walker will generally cover four to six miles. The ground may be uneven and hard on your legs. Swinging the club may put a strain on your back. So, again, preconditioning and warmup are the key to success and pleasure.

Perhaps the perfect form of exercise, however, is walking. Yes, walking. Many people, especially older people, don't want to take up the currently popular running and jogging. Many others, including increasing numbers of medical authorities, see health hazards in running and jogging, ranging from pulled muscles to sudden heart attacks. More attention is now being paid to that basic of all human activities: walking. Several new books focus on walking in great detail; one of the best is Raymond Dreyfack's *The Complete Book of Walking* (available from Farnsworth Publishing Co., 78 Randall Ave., Rockville Centre, NY 11570, for \$9.95 plus \$1 postage and handling).

Dreyfack describes "pace walking," a technique of brisk, vigorous, regulated walking tailored to individual ability. We all walk, of course, but we seldom walk briskly or consistently. Many of us, in fact, hop into our cars for the slightest errand, instead of walking at all. A considerable amount of exercise can be gotten (and gasoline saved) if you try to do some errands on foot, climb stairs wherever possible and, when you must take your car, park some distance from your destination. One man lost 14 pounds in several months by parking his car a mile from his office and walking that mile each morning and evening.

Walking is good, but pace walking, according to Dreyfack, is even better. Because pace walking is individually designed, it does not specify any particular rate of speed applicable to all. Instead, it tells you to walk at a moderate and comfortable rate, and time yourself as you walk. If you use a watch with a sweep-second hand, you can see how many steps you complete in a minute. Repeat the timing a few times to be

(Continued on page 45)

You worked hard most of your life. Now your age can work for you.

AARP is an organization created exclusively for people 55 or over. Its main purpose is to keep vital people in the forefront of life, participating and contributing. Profitably.

AARP stands for the American Association of Retired Persons. It is non-profit and non-partisan. For people retired or not, active or not, healthy or not so healthy. There are now more than 11 million members across the country who are taking advantage of their age. Through AARP.

For only \$3.00 a year, you and your spouse can join AARP and take advantage of all its unique benefits and services.

Meet with people your own age.

At over 3,000 Local AARP Chapters across the U.S. people are meeting to improve the quality of their lives, to make new friends and get involved.

Travel Discounts

Whether you want to travel around the world or across the country, AARP membership helps you do it right. AARP members can get significant discounts at most locations of these famous hotel and motel chains; Holiday Inns, Howard Johnson Motor Lodges, Rodeway Inns, Sheraton Hotels and Inns, Scottish Inns, and Treadway Inns. Car Rental discounts are also available to members from Hertz and Avis.

Pharmacy Discounts and Service.

AARP's more than 11 million members provide the buying power that gets you prescriptions and over-the-counter medicine at discount prices. Also they're mailed to your home, postage paid.

Health Insurance.

Unfortunately, there are certain health care expenses which Medicare does not cover. One of AARP's important benefits is eligibility for group health insurance coverages that provide extra protection.

Community Involvement

At Local AARP Chapters you can find ways to help your community and yourself through Defensive Driving Courses, Consumer Information Desk and The Tax Aide Program.

"AARP showed David and me that being over 55 had advantages we never dreamed of."



Important Reading

AARP provides new members with a series of booklets that guide retired people through areas of particular concern. And when you join AARP you automatically receive two subscriptions. One to Modern Maturity, a full color bi-monthly magazine and one to AARP News Bulletin. Exclusive AARP publications with a variety of news and features of special interest to you.

How to Join AARP

Just fill out the coupon below and send \$3.00* for one year's dues. It's that simple. The coupon immediately enrolls you to take full advantage of all the AARP benefits and services. There's only one requirement. You must be 55 or over, retired or not. If you are, welcome to the club.

Motoring Club

If you own a car, you might be interested in the security that comes from 24-hour emergency road and towing service, personalized trip planning, and lock-out or lost key protection. As an AARP member you can get these benefits and many more by taking advantage of your eligibility to join the AARP Motoring Plan provided by the Amoco Motor Club at a special low membership fee of only \$19.95 a year.

Government Representation.

AARP's legislative program represents the interests of people age 55 and over before state legislatures and Congress. Over 11 million AARP members make their voices heard for all those 55 and over.

*Membership dues include \$1.40 for annual subscription to Modern Maturity and \$.60 for the AARP News Bulletin.

JOIN AARP

1909 K Street, N.W., Washington, D.C. 20049

I am 55 or older:

Please enroll me as a member of AARP. I understand that it makes me eligible for all AARP benefits and privileges.

Enclosed find \$3 (one year dues) \$8 (3 years dues) Bill me later.

Name _____

Address _____ PMRBN

City _____ State _____

Zip _____ Birthdate _____

One membership makes both member and spouse eligible for all AARP benefits and privileges, however, only one may vote. Please allow 30 days for delivery of your membership kit.



SCHOLARSHIPS for STUDENTS

BASED ON SCHOLARSHIP, LEADERSHIP AND FINANCIAL NEED

ELKS NATIONAL FOUNDATION

TRUSTEES OFFER \$880,000 IN 1980 AWARDS

FOR THE ACADEMIC YEAR 1980-1981 the Elks National Foundation Trustees are offering 1,223 college scholarships ranging from \$600 to \$3,000 and totaling \$880,000.00.

During the many years in which this annual scholarship assistance competition has been in existence, the Elks National Foundation has helped thousands of worthy American students of good character and behavior patterns, and with superior scholastic attainments and leadership qualities, to begin their college education under favorable circumstances.

The 1980 Schedule of Awards includes 500 "Most Valuable Student" Scholarships awarded in nationwide competition, and 723 scholarships each for \$600 allocated on a state-quota basis. Six special four-year scholarships are to be awarded to the three highest rated boys and girls in the 1980 competition.

Applications may be made by students in the graduating class of a high school, or its equivalent, who are citizens of the United States of America and residents within the jurisdiction of the B.P.O. Elks.

Scholarship, leadership and financial need are the criteria by which applicants are judged. Experience shows that students who qualify for final consideration usually have a scholarship rating of 90% or better and stand in the upper 5% of their classes.

All scholarships are in the form of certificates of award conditioned upon the enrollment of the winners in an undergraduate course in an accredited college or university.

Application must be made on an official form furnished by the Elks National Foundation and entitled "Memorandum of Required Facts," which will be available at Elks lodges after December 1, 1979. Applications, properly executed, must be filed not later than February 11, 1980 with the Scholarship Chairman or Secretary of the Elks lodge in whose jurisdiction the applicant resides.

Lodge officers are requested to noti-

fy school principals of this scholarship offer, to publish it in lodge bulletins and make every effort to bring it to the attention of qualified students.

Applications will be reviewed by lodge and district scholarship committees and then judged by the scholarship committee of the State Elks Association for inclusion in the state's quota of entries in the national competition. Names of winners will be an-

nounced about May 1, 1980.

Requests for additional information should be addressed to the Scholarship Chairman of the State Elks Association of the state in which the applicant is resident.

The National Association of Secondary School Principals has placed this contest on the Advisory List of National Contests and Activities for 1979-1980.

Trustees of the Elks National Foundation are the following Past Grand Exalted Rulers:

John L. Walker, Chairman
William A. Wall, Vice-Chairman
Horace R. Wisely, Secretary

E. Gene Fournace, Treasurer
Glenn L. Miller, Assistant Treasurer
Robert A. Yothers, Assistant Secretary
Willis C. McDonald, Member

SCHEDULE of "MOST VALUABLE STUDENT" AWARDS for FEBRUARY-1980 CONTEST

For high school seniors only. College students are not eligible to enter this competition. Identical awards for boys and girls, competing separately.

	BOY/GIRL (each)	TOTAL AWARDS
STATE FINALISTS		
"MOST VALUABLE STUDENT"		
SPECIAL FOUR-YEAR AWARDS		
for the 1980-81, 1981-82, 1982-83, 1983-84 academic years		
First Award—Two for each academic year.....	\$3,000.00	\$ 24,000.00
Second Award—Two for each academic year.....	2,500.00	20,000.00
Third Award—Two for each academic year.....	2,000.00	16,000.00
FOR THE 1980-81 ACADEMIC YEAR		
Two Awards for one academic year.....	1,750.00	3,500.00
Two Awards for one academic year.....	1,500.00	3,000.00
Two Awards for one academic year.....	1,250.00	2,500.00
Two Awards for one academic year.....	1,100.00	2,200.00
Twenty-six Awards for one academic year.....	1,000.00	26,000.00
Sixty Awards for one academic year.....	900.00	54,000.00
One Hundred Fifty Awards for one academic year.....	800.00	120,000.00
Two Hundred Fifty Awards for one academic year.....	700.00	175,000.00
500 STATE FINALIST AWARDS.....		446,200.00
STATE ALTERNATES		
ALLOCATED AWARDS		
for the 1980-81 Academic Year		
723 STATE ALTERNATE AWARDS at \$600.00 each.....		433,800.00
1,223 AWARDS for a GRAND TOTAL of.....		<u>880,000.00</u>



NEWS OF THE LODGES

The American flag served a special purpose at three lodges recently. Then-DDGER Jerry Wieber and ER Donald Wright of **Homer, AK, Lodge** presented flags to 90 Russian immigrants who became U.S. citizens. **Santa Barbara, CA, Elks** presented a flag, a flag staff, and a granite memorial plaque to their city in honor of veterans. Mayor David Shiffman was joined by ER Cecil Whetstone and PERs D. W. Merrow and Anthony Jimenez. At **Natchez, MS, Lodge**, Tim McGivaren and Lt. Cmdr. John McGivaren Jr., sons of deceased Brother John McGivaren, presented an American flag, which had belonged to their father, to Natchez Brothers.

The success of **Escondido, CA, Lodge's Children of 1687**, a program which includes vision screening for preschool children, was shown through a letter of thanks sent by a mother of a child who had been tested. Symptoms of amblyopia were detected when Curtis Marsh had his eyes examined. The early detection and a visit to an ophthalmologist facilitated effective corrective measures.

Eleven-year-old Todd Harris received a motorized wheelchair from **Tacoma, WA, Lodge**. The presentation of the gift was made by Brothers Tom Murphy, Mike Saltvick, H. Smith, and Tiler Frank Roach. Todd and his par-

ents thanked the Elks for their generosity.

Students were honored by two lodges recently. Chm. and PER Ronald Creel presented a certificate and a \$500 college scholarship from **Montgomery, AL, Lodge** to Amy Brantley, who was selected Teenager of the Year. The Elks of **Charleston, WV, Lodge** combined their presentations with the annual awards ceremony of Clendenin Junior High School. At the school's recognition assembly, Secy. Larry Baker presented Student of the Year certificates to Bobby Huffman, Tammy Huffman, and Brad Barnhouse.

A giant garage sale netted \$1,100 for the Elks' ladies of **Canton, OH, Lodge**. Mrs. Robert Long, chairwoman, and ER James Cooper presented checks to the National Foundation, the Ohio Elks Cerebral Palsy Fund, which is the state major project, and the Stark County Handicapped Associates, an organized group of independent handicapped persons. The Brothers of Canton Lodge joined the recipients in thanking the ladies for their generous donations.

A recent initiation at **Hampton, VA, Lodge** was held in honor of PDD Francis Howard. Brother Howard presided over the class of 21 initiates and was

joined by his sons-in-law Paul Culotta and Robert Hall and grandsons Steven Saunders and John Shatto, all of whom are Elks.

Concerts at **Florida's** Stuart-Jensen, Jupiter, and Lake Worth lodges were scheduled to raise money for the state major project, the Harry-Anna Crippled Children's Hospital. Brother Woody Martens, who has given the benefit performances for over 13 years, and Brother Ed Slater, who joined the act three years ago, have raised over \$115,000 for the major project.

Fifteen cyclists helped to raise money for New Hampshire's major project, the Copper Cannon Lodge summer camp for underprivileged children. Participants of the bike-a-thon ranged in age from 11-51 and covered 13 miles to earn pledge contributions from local donors. Sponsoring **Laconia, NH, Lodge's** Chm. Barry Beede was among those to complete the course.

After three years of raising funds, the Elks of **California's** North Central District combined their total of \$40,-837.93 with \$40,000 contributed by the Swing at Cancer, Inc. to purchase a mobile blood bank for the local citizens. Chm. John Chubon of Carmichael Lodge headed the fund-raising program, which included a \$3,000 donation from the Carmichael Elks' ladies.

Fraternal News Flash

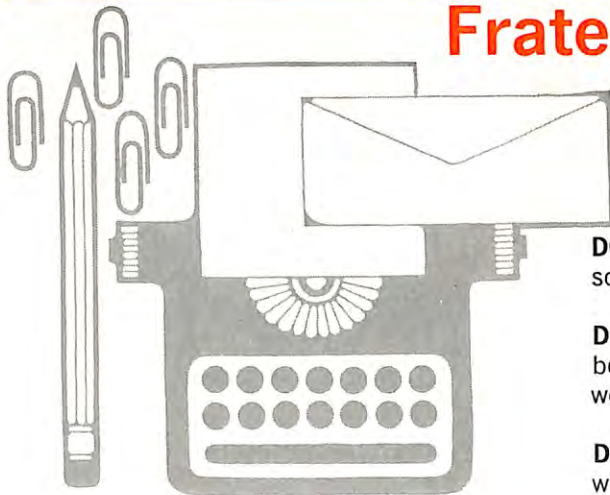

The *Elks Magazine* is your means of communication with Brothers throughout the nation. Let us help you spread the news of your lodge's activities. When you submit items for publication, keep these tips in mind:

• **DO** select clear, good quality prints. Check photos and negatives for scratches, spots, and fuzziness before you submit them.

• **DO** send your news in as soon as possible. If you send in an item at the beginning of March, the earliest it can appear is in the May issue. Three weeks after the event is the deadline.

• **DO** be sure to include all the pertinent information—who, what, where, why, and when.

• **DON'T** send polaroids, color photos, color negatives, photos of more than 20 people, or items concerning mandatory activities.

A complete list of the news department's criteria for publication may be obtained by sending a self-addressed, stamped envelope to:

**Editor of Fraternal News
The Elks Magazine
425 West Diversey Parkway
Chicago, Illinois 60614**



We'll look forward to hearing from you.

A DINNER party was held at Jersey City, NJ, Lodge to celebrate the lodge's anniversary recently. During the evening, a \$100 savings bond was presented to Richard Kabrt (third from right), who also received a \$100 savings bond from the state association and \$600 from the Grand Lodge in the Most Valuable Student Contest. (From left) Chm. Robert Bell, ER Edward Meehan, PDD Frank Brinkofski, and Mr. and Mrs. Kabrt congratulated Richard.



AMERICAN flags which were tattered, soiled, or otherwise unserviceable were disposed of in a ceremony conducted by Connecticut Elks at Westbrook Lodge. State Americanism Chm. Gordon Benedict (second from left) supervised the burning of 450 American flags. The ceremony was attended by 300 Elks and their guests, including (from left) VP Joseph Palmer, Dist. Chm. Charles Nelson, SP Francis Reinholz, and Dist. Chm. Chester Bedell.



THE CHAMPIONSHIP trophy for victory in the 18th Annual Elks National Golf Tournament sponsored by Southern Pines, NC, Lodge was presented to Arman Fletcher (second from left) of Princeton, WV, Lodge. Brother Fletcher captured the trophy for the ninth time and had a three-round total of 223, one stroke over Wilbur Jerles of Cambridge, OH, Lodge and two strokes over Rev. Michael Garber (second from right) of Southern Pines, NC, Lodge. ER Gurney Bracey (left) of hosting Southern Pines Lodge and Russ McGuiney (right), tournament director, presented the awards. Brother Garber also was honored as medalist over the Southern Pines course and was the captain of the champion Southern Pines Lodge team. There were 460 participants in the tournament. The golfers played on three courses, Southern Pines "Elk", Pinehurst No. Five, and Whispering Pines East.

Other awards were proffered to fourth-place winner Jere Hilburn of Goldsboro, NC, Lodge, fifth-place winner Vincent Tritch of Middletown, PA, Lodge, daily medalist Richard Walter Jr. of Charleston, WV, Lodge, and Billy Dillworth III of Rockville, CT, Lodge, who won the hole-in-one prize. A two-day Ladies' Tourney was held in conjunction with the men's contest and was conducted by Chairwoman Babs Scott. Nearly 65 women competed for six silver prizes. Next year's tournament will be held May 22-24, and plans to expand the women's contest were considered.



A BLOCK party, including a barbecue and a street dance, was sponsored by Fort Pierce, FL, Lodge recently. Special guests for the event were Beverly Aycock (right) and Kenny Frampton, who were once patients of the Harry-Anna Crippled Children's Hospital, the state major project. ER Martin Folan (left) welcomed the guests to the festivities, the proceeds of which amounted to \$2,000 and were contributed to the major project.



A SPECIAL visit was paid to the residents of the Riverview Nursing Home in Coventry, RI, by Coventry-West Greenwich, RI, Brothers recently. Flowers and candy were presented as gifts to the senior citizens. Magdaline Syldo and Gertrude Myers thanked (from left) Est. Loyal Kt. Leroy Craig Sr., Esq. Leroy Craig Jr., ER David Downey, Est. Lect. Kt. Richard Provencher, and Est. Lead. Kt. Jerry Bussiere for the presents.



AN OPEN house was held at Saginaw, MI, Lodge recently in celebration of PER William Humes's (left) 89th birthday. ER Lauren Mertz (right) extended best wishes to the PER. The two gentlemen viewed a portrait of Brother Humes, which will be placed on permanent display in the lodge.



THE ELKS little league championship was captured by the Cardinals recently. Sponsored by Mountain Home, AR, Lodge, the league competition culminated with the contest between two leading teams, the Cardinals and the Twins. Coaches David Osmon (right) and David Sumpter (left) congratulated the young athletes for their 14-0 record and season victory.



A GOLDEN anniversary was celebrated by Cedar City, UT, Lodge recently. The officers of Las Vegas, NV, Lodge, which originally sponsored Cedar City Lodge, were special guests for the dinner, meeting, and dance. ER Charles Edwin Harp of Las Vegas Lodge presented \$100 for charity programs and a commemorative plaque to hosting ER James Hale and charter members and PERs John Beal and Warren Bulloch.



AS THE RIBBON was cut at Wilkes-Barre, PA, Lodge, the new facilities were officially opened. On hand for the ceremony were (from left) Brother Robert Prawdzik, Committeeman Tom Jones, Trustee Franklin Hillard, Committeeman Nicholas Prokopchak,

PER Charles Sennick, Chm. Loren Sickler, Joseph Tirpak, chairman of the board of trustees, ER Edward Myers, Secy. Thomas Dugan, Brothers Bill Ashton, Stanley Penkalla, and John and Mrs. Holowiak, Mrs. Charles Sennick, and Mrs. Stella Pudlosky.



BROWSING in an antique shop in Florida led to the discovery of a World War I era Elks membership diploma. The framed document, which had been issued to Warren Harding of Marion, OH, Lodge, was recently presented by ER Donald Cameron Jr. of Palatka, FL, Lodge to then-GER Leonard Bristol (center). The Archives Room in the National Memorial Building in Chicago now houses the certificate, while a copy was presented to ER Donald Hensel (right) of Marion Lodge.

THE TERM of office came to a close for Michigan's SP William Murray (right) at the state conclave held in Muskegon. Brother Murray passed the responsibilities of heading the state association to incoming SP James Varenhorst (left). On hand to offer congratulations were PGERs E. Gene Fournace (second from left), state sponsor, and Frank Hise.



FLORIDA'S VP David Riley (fourth from left) of the Southeast District visited Jupiter, FL, Lodge recently. Greetings were extended by (from left) Est. Lect. Kt. Don Sheldon, Est. Loyal Kt. Pat Patchnin, ER Eugene Hall, and Est. Lead. Kt. Bob Smith. During a meeting and dinner held at the lodge, VP Riley delivered a speech in which he urged support of the National Foundation.

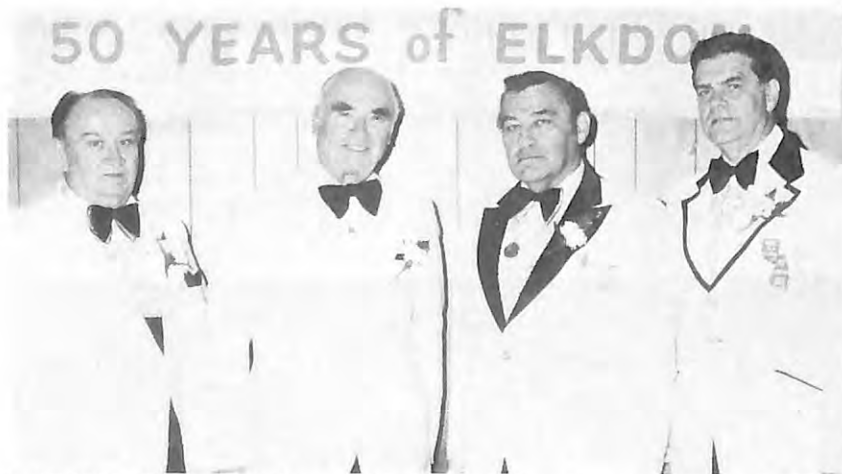

A DINNER-DANCE was held at Clifton, NJ, Lodge to commemorate its 50th anniversary. There were 200 people attending the affair. ER Thomas Henry (second from right) welcomed PGER William Jernick (second from left), who is celebrating 50 years in Elkdom, PDD Andrew Chambers (left) and DDGER Thomas Cox Jr.



THE IDAHO Elk of the Year Award was presented to Brother Arlo Giles (left) of Lewiston Lodge at the state convention. Secy. Donald Rainville (center), convention chairman, proffered the award to the honored Brother. Outgoing SP Sherman Akers (right) was on hand to offer his congratulations.

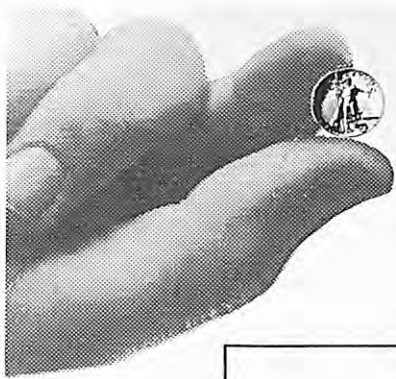

Actual Size!

The World's First Miniature \$20 Gold Piece



SOLID 14 KARAT GOLD - ONLY \$19.95

The Historic Providence Mint proudly announces the minting of the world's first miniature \$20 Gold Piece - in solid 14 karat gold

You have a rare opportunity to possess the world's first miniature \$20.00 Gold Piece in solid 14 karat gold. This coin is an exquisite duplicate - minted in exactly the same manner as the first Saint Gaudens \$20.00 Gold Piece struck at the U.S. Mint in 1907. Every detail - even the delicate sculpture of the tiny wing feathers is boldly defined. Carefully die struck in deep dimension, this truly magnificent coin highlights the unique Roman Numeral dates and the lustrous gold, mirror-like finish of Saint Gaudens original. Each of these magnificent \$20.00 gold pieces is protectively housed in a plush collector's case. And every one is accompanied by an individually numbered Certificate of Authenticity and a 30 day money-back guarantee.

AVAILABLE FOR A LIMITED TIME!

This fabulous \$20.00 Gold Piece in solid 14 karat gold is available exclusively from the Historic Providence Mint. The price - for a limited time only - is \$19.95. This price is

guaranteed until December 31, 1979. However, due to the rising gold market, we urge you to act promptly. Send for your coin TODAY!

Due to fluctuations of gold and silver prices on the world market, we reserve the right to withdraw this offer at any time. Current price is guaranteed only until December 31, 1979.

The Historic Providence Mint

Dept. M EL-3, 222 Harrison St., Providence, R.I. 02901

Please send:

..... G1 14 Kt. Miniature \$20 Gold Piece(s) at \$19.95 each plus 75¢ Postage and Handling.

Enclosed find check or M.O. for total amount due \$

Please charge: Bankamericard/Visa Mastercharge

No. Exp. Date

Signature

Send to

Address

City State Zip

RUSH my order. I enclose an extra \$1.00 for First Class Mail.

WITHIN 2 OR 3 YEARS OF RETIREMENT?



ENJOY an Arizona Vacation in a lovely apartment in

Sun City West
STANDARD OF THE WORLD IN RESORT-RETIREMENT LIVING

A FABULOUS RESORT VACATION \$150*
FOR ONE OR TWO PEOPLE JUST

Golf, tennis, swimming and special parties are just a few of the things you'll be invited to enjoy. Plus you'll stay in a beautiful air conditioned apartment with a completely equipped kitchen, color TV, attached carport and private patio. Just 15 miles from exciting Phoenix. Easy drive to the Grand Canyon, Mexico or Las Vegas.

*INTRODUCTORY RATE:

For 1 week: Oct. 16, 1979-May 31, 1980
For 2 weeks: June 1, 1980-Oct. 15, 1980
Rates subject to change without notice

MAIL THIS COUPON TODAY!

DEL E. WEBB DEVELOPMENT CO. DEPT. EM-119
P.O. BOX 1725, SUN CITY, ARIZONA 85372

Send all details on the \$150 Vacation Special plus full-color brochure to:

Name _____

Address _____

City _____ State _____ Zip _____

*One guest to be 50 or over, none under 18. Reservations limited to available dates. Return visit Rate: \$200

13601 Meeker Blvd., Sun City West, AZ

Equal Housing Opportunity Employer

Sun City West is not a lot sales development

PROSTATE RELIEF

Banish prostate misery! Relieve problems like pain, dribbling, urgency, retention, and getting up nights. Send now for FREE report! **Relief.** Dept. EK-3, Box 23181, Wash., DC 20024

FREE REPORT

Rush FREE report on prostate relief.

Name _____ Age _____

Address _____

City _____ St _____ Zip _____

Relief, Dept. EK-3, Box 23181, Wash., DC 20024

TRY A CAREY PIPE
FREE FOR 30 DAYS

Top grade selected briar with exclusive innovation. Guaranteed best smoke you've ever had—or smash pipe with a hammer! Write for free brochure of styles and shapes... or Call toll-free **800/621-5809** (In Illinois: 800/972-5858)

E. A. CAREY CO. Dept. 204T

639 Academy Drive, Northbrook, IL 60062

Amazing Magic Inch smokes like no other pipe



HYDRAULIC JACK REPAIRS

Earn While You Learn In Your Spare Time

Trained and qualified mechanics needed NOW to service inoperative hydraulic jacks. BIG opportunity for ambitious men. We show you HOW—in your basement or garage to earn spare time cash in an expanding industry. Don't wait, ACT NOW! Get the facts.

Write for folder E11 and free bonus offer

Hydraulic Jack Repair Manual Co., Inc.

G. P. O. BOX 3 • STATEN ISLAND, N. Y. 10314



MEDICINE AND YOU

by Larry Holden

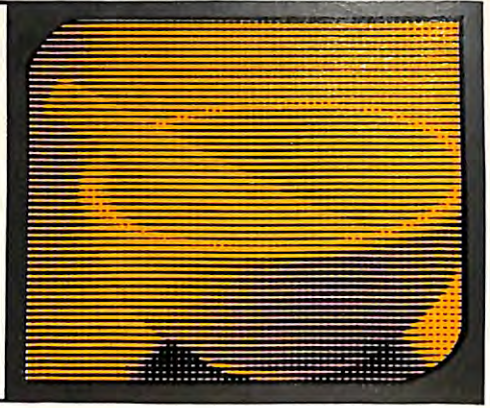

PUTTING THE PINCH ON SALT

A couple of months ago, this column sampled the sweetness of fructose. Now it's time to give salt a fair shake, no matter if we learn the bitter truth...

Salt (sodium chloride) is a versatile flavoring, acceptable to most people and far simpler to use than a suitable combination of herbs, spices and lemon juice. A small amount of sodium is essential for cellular processes. But in the long run, the body needs very little salt.

Our earliest ancestors, who were mostly hunters, probably found more than enough salt in meat from the animals they killed. But with the dawn of agriculture and the development of a new type of diet several thousand years ago, people had to work hard to make salt, usually evaporating it slowly out of sea water or naturally brackish springs.

Today, most salt is extracted from the ground by complex machinery. Manufacturers add small amounts of magnesium carbonate and silicate to keep it from clumping in humid weather. "Sea salt," evaporated from sea water, is favored by some people who mistakenly consider it more healthy. In actuality, sea salt hardly differs from the ordinary kind, except that it contains some additional impurities, which sometimes give the salt a better flavor, but its biochemical effect on the body is the same.

No matter what kind of salt we use, the question is not whether we need it (we do), but how much we should consume. According to most experts, we consume ten to twenty-five times as much salt as we need. In health circles in recent years, salt has become *persona non grata*.

Some doctors refer to it as a killer, since the sodium it contains appears to be a major precipitating cause of potentially fatal high blood pressure, or hypertension. This insidious disorder, which afflicts some 25 million Americans and often produces no symptoms until it has done irreparable damage, can lead to kidney failure, stroke and heart disease.

There is no question now that salt is important in the production of hypertension. In fact, the percentage of the population developing hypertension in any country is directly proportional to the salt intake among its people. Throughout the world, current populations that live on low-salt diets never develop hypertension. In fact, their blood pressure

does not rise with age as it does in the typical American: If anything, it drops.

Other hazards of a high-salt diet include edema, or swelling of body tissues, and extreme symptoms of premenstrual tension. One headache specialist has found that salt restriction reduces the frequency and severity of migraines.

For athletes and others who indulge in vigorous exercise, a large dose of salt, to replace salt lost through sweating, can be harmful and even fatal, causing a loss of potassium (needed for muscle contraction, including the heart muscle) and thickening of the blood. Salt tablets are unnecessary and dangerous. In fact, athletes have been shown to perform better in hot weather if they reduce their salt intake; over a period of weeks the body learns to conserve salt and less is lost through sweating.

Actually, our taste for salt is an acquired one. No salt needs to be added to the diet to meet the body's need for sodium, which amounts to only 220 milligrams a day. The Senate Select Committee on Nutrition and Human Needs recommended that, instead of the 10 to 24 grams of salt consumed per person each day, Americans should eat at most 5 grams (which supplies 2,000 milligrams of sodium, more than enough for practically everyone under all circumstances). Others recommended even less salt.

Once high blood pressure develops, salt restriction should be the first line of treatment. It is cheaper and less hazardous than taking blood pressure-lowering drugs for the rest of your life, and a Melbourne, Australia, research team has shown that salt restriction can be as effective as drug therapy.

You expect a lot of sodium in salty foods. But you might be surprised to discover that a one-ounce serving of Kellogg's Corn Flakes contains nearly twice as much sodium as an ounce of Planter's Cocktail Peanuts. You know potato chips are salty. But would you guess that two slices of Pepperidge Farm White Bread contain more sodium than a one-ounce bag of Lay's Potato Chips?

One bite tells you that bacon is salty. But how about a sweet pudding? One-half cup of Jello-O Chocolate Flavor Instant Pudding contains almost four times the sodium in a three-slice serving of Oscar Mayer Bacon. In fact, there's

(Continued on page 45)

THE \$150.00 SHINE.

MILLIONS ARE ALREADY SOLD.

Millions and millions see our \$150.00 Shine Power Gloss ads in Car & Driver, Motor Trend, Mechanics Illustrated, Popular Science, Road & Track, Popular Mechanics – and 20 other top magazines – to help make this business opportunity a real success for you.

NO COMPETITION.

Power Gloss is not available in retail stores, so all of those thousands of prospects in your area are yours – that's why it's urgent to act on this opportunity now. "My firm is sharing



Bob Lancaster, President, Torco Oil Company, Member Society of Automotive Engineers

its exclusive worldwide Power Gloss franchise with independent direct sales distributors all over America. Torco Oil Company owns the Power Gloss manufacturing rights and trademark rights registered in the U.S. Patent Office – to protect everyone participating in this money making opportunity."

IMMEDIATE PROFITS.

You make money right from the beginning – without the usual franchise fees, start-up costs, royalties or dues of any kind – your first sale makes a profit – and because Power Gloss is a utilitarian product, you will benefit from repeat profits, over and over again – year around.

NO FRANCHISE FEES, ROYALTIES OR DUES.

Very rarely is a nationally advertised product reserved for independent direct sales distributors – and not very often is an exclusive franchise shared with distributors without a fee, royalty, or dues of any kind. That's why you should act on this opportunity right now, and be first in your area.

Order a bottle of Power Gloss from this ad – get acquainted with its surface sealing and protective properties – its brilliant shine – and the facts of how to become a successful Power Gloss distributor.

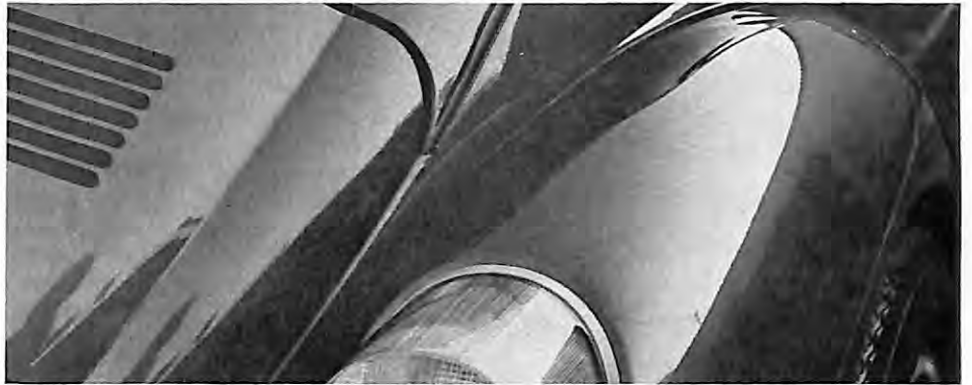

Dealers bring their Rolls, Mercedes, Jaguars, etc., into our shop and pay up to \$150.00 for a Power Gloss application because the Power Gloss brilliant shine and protection is the finest they can find. And, we guarantee it for 18 months.

THAT SAME SHINE IS YOURS FOR \$15.00.

Now even your bug can wear the Rolls Royce \$150.00 shine for only \$15.00. Your shine and protection also carries our written, registered 18 month guarantee.

Power Gloss is a catalytically hardened silicone that forms a clear, tough, transparent shield. Once applied, this shield seals the surface against the sun, smog, detergent, gasoline, saltwater air, road oils and just about everything else.

NOTHING STICKS.

Power Gloss dries so hard and slippery that nothing gets a grip on your finish. Grit, tar, grease, bugs, tree sap and ever-present bird droppings slide off the surface with just a soap and water washing. Then the diamond bright shine reappears with no rubbing or buffing.

SHINES AND PROTECTS ANY NON-POROUS SURFACE.

Power Gloss resists scratches, restores sparkle and cuts maintenance on paint, fiberglass, procelain, plastic, chrome, glass, brass, stainless steel, aluminum and practically anything you can think of.

One easy hand application of Power Gloss covers 200 square feet, that's two coats on a full size station wagon. Power Gloss is immune to temperature extremes. The shine and protection is so crystal clear you can apply Power Gloss to your windshield and forget about bugs, birds and hard-water stains. Pilots treat their planes with Power Gloss to cut wind resistance and boat engines have picked up as many as 200 rpms after Power Gloss was applied to the prop and rudder.

If all this sounds amazing, remember we've got to give people something special when we charge them \$150 to polish their car.



MAIL IN THIS COUPON AND GET STARTED IN YOUR OWN PROFITABLE BUSINESS TODAY.

POWER GLOSS • BOX 2566 • DEPT. EM119 • SANTA FE SPRINGS, CA 90670

Send me a "Business Opportunity Kit" only.
Send me a "Business Opportunity Kit" and find enclosed \$_____ check or money order for the following:

- 1 pint – Power Gloss at \$15.00 (include \$2.00 for postage and handling).
 3 pints – Power Gloss at \$39.95.



We pay postage and handling on orders of 3 or more.

NAME _____ AGE _____

ADDRESS _____

CITY/STATE _____ ZIP _____

BANKAMERICARD, VISA AND MASTER CHARGE ACCEPTED

Acct. No. _____

Exp. Date _____

Signature _____

California residents add 6% sales tax. No C.O.D.

Torco Oil Company, 12247 Lakeland Road, Santa Fe Springs, CA 90670

WORLD FAMOUS
BLACK HILLS
GOLD
 ORIGINAL JEWELRY

FREE
Christmas
Gift
Catalog

Call Toll Free
1-800-843-9874

or Write:

The Golden Knight
 Box 47 Sioux Falls, S.D. 57101

No paste or powder
holds dentures
comfortably tight
for weeks like Snug
 Denture Cushions

Not a messy paste, powder, cream or wax pad—but an amazing soft plastic adhesive cushion. Snug® Brand Denture Cushions hold loose, wobbly dentures comfortably tight for weeks. With Snug there's no need to bother with messy daily "fixing." It lasts for weeks, sticks to your plate not to your gums, so easy to clean or remove. Get Snug Denture Cushions to hold your dentures tight and firm for weeks...in comfort. At all drug counters.

GAME ROOM EQUIPMENT

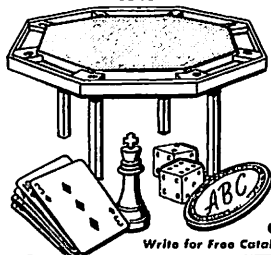

The Biggest Selection
 of Finest Quality

- POKER TABLES
- Non-Duplicate
 Manogrammed
 POKER CHIPS
- Imprinted
 PLAYING CARDS
- Manogrammed
 PERFECT DICE
- DICE CUPS

at the right price!

Write for Free Catalog Today!

GEORGE & CO., 615 Main St. Dept. E, Buffalo, N.Y. 14203

SPECIAL OFFER
GET A 1909 V.D.B.
LINCOLN CENT
ONLY \$2.00

Designer's initials (VDB) appear on a limited number of 1909 cents. Full story plus wonderful price lists. Limit 1. ADULTS ONLY. Send \$2.00 to: LITTLETON COIN CO., DEPT. LC-42 Littleton New Hampshire, 03561



The Cadre Noir

(Continued from page 18)

him, thus placing himself squarely in opposition to the most rigid adherents, many of whom never rode their mounts outside of the Manege. Count d'Aure put up an obstacle course in the countryside surrounding Saumur, called the Chermin Vert. This was the forerunner of today's cross-country competition. In 1902, France again took the lead, holding the first real combined training event, the most exciting of all equestrian sports—and a sport that is now dominated by the United States, thanks to a former member of the Cadre Noir.

Combined Training, also called Three Day Eventing, is the most complete and demanding test of the qualities and talents which go to make up the truly all-around horse and rider. Eventing is a difficult form of equestrian competition, similar to the decathlon, as the horse must have all-around athletic ability. Combined Training originated

as a competition for cavalry horses. In the days when each country depended upon the cavalry in battle, horses were a vital part of any army, and a soldier's life often depended upon the courage, speed and stamina of his horse. Thus, a competition then known as "the military" was devised. In France, the combined training competition is referred to as the *concours complet*, the complete competition.

The *Dressage* test is held on the first day of the Three Day Trials to show that the horse possesses the obedience, suppleness and free forward movement to perform with ease. The second day, the speed and endurance of the cross-country phase is the heart of eventing. Horse and rider must survive ten miles of road and tracks, two miles of 4'6" steeplechase jumps and six miles of cross-country jumping. Here the horse must jump 36 extremely difficult obstacles of the most frightening proportions, within a prescribed time. Stadium jumping on the third day is to

(Continued on page 46)

ELKS MEMORIAL SUNDAY

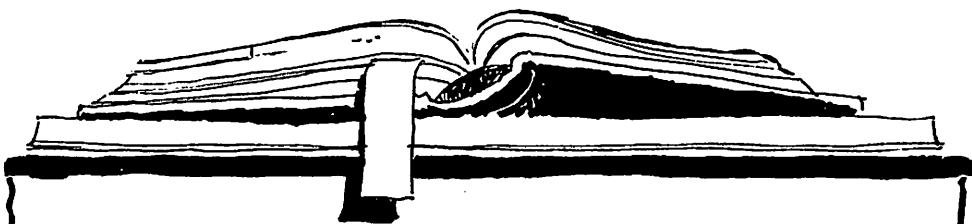

Please reserve Sunday, December 2, 1979, to attend the Memorial Service at your lodge to recall the memories of our departed Brothers. These programs are open to every member of your family, and they are a rewarding experience for all who attend. Every Brother should attend at least one of these services, as the programs are short and inspiring. They include some of the finest artistry your community has available and offer a spiritual message for everyone. Plan now to attend.

Maybe you would like to be part of this program. If so, contact your Exalted Ruler and tell him that you would like to be involved. There are many ways that you can help. As an artist, you may help with decorations, or you may escort one of the widows to the service or act as an usher. Maybe you can help on the buffet. The Exalted Ruler will be most appreciative of your help. Every Brother should make an effort to make this year's program the most outstanding in his lodge's history.

Each lodge is urged to enter the Brochure Contest for Memorial Sunday Observance. Those Brothers who have prepared a brochure of their program have improved their presentation each year. The brochure should be of standard size, 8½ by 11 inches, with all phases of the program properly documented with pictures and newspaper clippings. Entries will be judged on the program, attendance, decorations, publicity, and appearance. All entries are to be sent to Jack L. Riordan, 634 Vista Oro, Palm Springs, CA 92262 on or before February 1, 1980.

Plan now to attend, and the chimes of memory will peal forth the friendly message, "to our absent Brothers."

Jack L. Riordan, Member
 GL Lodge Activities Committee

GIANT MEMO CALENDAR

**YOUR
SPECIAL
PHOTO
ENLARGED
400%
IN FULL COLOR
NEW FOR 1980**
only **\$2.99**



TO
THIS

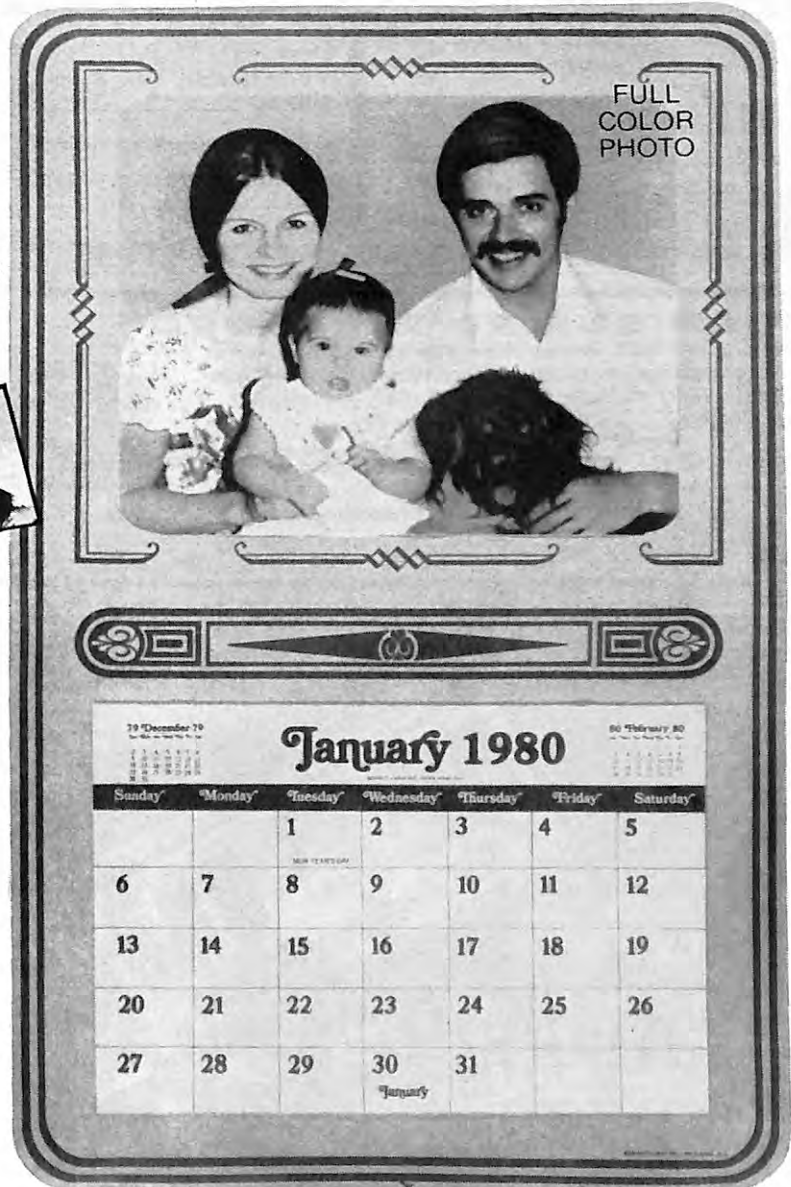

□ Now your favorite photo can become a superb, lasting and beautiful wall calendar — to hang all the year long where it will bring you pleasure every day. Or, as a gift to remind a special person of your thoughtfulness and love.

A new scientific breakthrough makes it possible to *enlarge*, with absolute fidelity and clarity, any color photo and reproduce it in GIANT size. You get all the tones, all the beauty, all the vibrant live colors, so exactly that the giant photo seems actually **better than the original!**

Any photo — color or black and white — can be used, and will be returned to you in perfect condition. Even a tiny 3" x 4" snapshot becomes a giant 8" x 10" printed on a fine quality linen-look calendar that is 14" x 22" overall. And the calendar is a year-round aide, with plenty of room for notes, reminders, appointments, red-letter days, etc.

The price is super, too. Only \$2.99! An incomparable value these days. Just send your favorite photo or slide. We'll even mail calendars for you to any list of people you want to send us.

Use handy order coupon. Prompt service and satisfaction guaranteed.

BENNETT-GRAF, Inc.
1450 N.E. 123 Street, Miami, Fla. 33161

BENNETT-GRAF, Inc. Dept. 4041
1450 N.E. 123 Street, Miami, Fla. 33161

Please rush _____ Giant Photo Calendar(s) enlarged from the photo(s) enclosed. (When ordering calendars to be sent to more than one person, enclose list of names and addresses on separate sheet).

For each calendar I enclose payment of \$2.99 plus 50¢ to help defray postage and handling charges.

Total Payment enclosed \$ _____
(Fla. residents, add sales tax)

SEND TO (NAME) _____
STREET _____
CITY _____
STATE _____ ZIP _____

**We use
Kodak paper...
for a good look.**

RETIRE IN FLORIDA'S

FINEST MOBILE HOME COMMUNITY

From only \$24,900 on Florida's Atlantic Coast there is beautiful lake country where you can retire on a sensible budget in an adult community of doublewide mobile homes.

Phone toll free 1-800/237-9494 for more information on how to get full enjoyment out of Florida retirement living. Or fill out the coupon. →

VILLAGE GREEN

at Vero Beach / A Lakefront Community of Distinctive Mobile Homes



MAIL TO: VILLAGE GREEN
Dept. 3703 P.O. Box 6037
Vero Beach, FL. 32960.

Name _____
Address _____
City _____
State _____ Zip _____
Phone _____

FIND BURIED TREASURE

Find buried gold, silver, coins, treasures with powerful new electronic detector. Ultra sensitive. Penetrates deep into earth. Works through mud, beach sand, rock, wood, etc. Signals _____ when object is detected.



Write for Free Catalog

RELCO Dept. DD29. Box 10839, Houston, Tex. 77018

Lady Luck

(Continued from page 8)

One broker tells us of a dentist who buys stock only in those companies he has discussed with businessmen who are his patients. And a housewife in Detroit has advised her broker of her pet superstition—"Never on Monday." She has ordered him never to buy stocks for her—or sell—on Monday. Both of these individuals have made very profitable investments. Is their success due to "lady luck?"

There is nothing wrong with discussing stocks with businessmen, whether in the dentist chair or anywhere else. We are told this knowledge could considerably add to your wise investment procedures. As far as Mondays go, the market has been known to fluctuate more on Monday than on other days because of the backlog of Friday buy-and-sell orders, as well as favorable or adverse weekend news. Such investment practices, although based on personal characteristics, undoubtedly owe their success to underlying facts as well as "lady luck."

Is there such a thing as a "run of luck" or bad luck? Science has not yet been able to answer all the questions about luck, but many studies show that for most people, good luck—or bad luck—tends to go in cycles. In tabulating the results of various games of chance, for instance, it was found that subjects who were lucky tended to remain lucky for a given period of time. Then their luck changed, and they began to lose.

The important thing is to learn to limit your losses—the lucky people discard bad luck before it becomes worse luck. It is always hard to say, "I was wrong," but how much better to get out from under a loss while it still doesn't hurt you very much. A minor loss is better than sticking it out until the cement hardens around your feet and you are stuck for life. A self-made millionaire and Swiss banker recently summed it up this way: "If you are losing a tug-of-war with a tiger, give him the rope before he gets your arm. You can always buy a new rope."

Inevitably, when you start something new, there is always the possibility that you may fall flat on your face. However, when failures occur as the result of calculated risk-taking, they are seldom the total disasters we fear they are going to be. As Aldous Huxley once said, "Experience isn't what happens to you. It's what you do with it." And after making every possible preparation, you will most likely find that the odds are still not 100 percent in your favor—there is always an element of risk.

Dr. Natalie Shainess, well-know psy-

Traveling Companion

The nicest little clock radio available anywhere... that goes anywhere.

CALL 800-621-5554

Illinois Residents call 800-972-5858



It's light. Small. Extremely practical. With all the features and conveniences of the clock radio by your bed—shuts itself off so you can fall asleep to your favorite music... wakes you to music or buzzer tone alarm... with snooze button and night light.

Try it on 15 day money back guarantee. Call toll-free to charge it to your national credit card or send just \$39.95 plus \$3.30 for shipping (\$49.95 for AM/FM model) to Douglas Dunhill. (Ill. add sales tax.) In rich black and anodized silver. Complete with penlight batteries and carrying case. You'll never worry about or miss a wake up call again.

Douglas Dunhill
INC. AFFORDABLE QUALITY

DEPT. 64 - 1614
TEN DOUGLAS DUNHILL DR., OAK FOREST, ILL. 60452
© Douglas Dunhill Inc. 1979



Actual Size: 5 1/2" Long x 2 1/2" High x 2" Deep.

chiatrist, believes the more we act to change our luck, the more we take charge and the more secure we feel.

If you begin to see a pattern of things going wrong, or a rash of bad luck, ask yourself—"What is my role in this? Why do I feel trapped in this situation? What makes me complain about it instead of doing something about it?" In other words, be self-critical.

History is full of people who succeeded in accomplishing their goals after having had many failures and runs of bad luck. For instance, did you know that when Thomas Edison was looking for a substitute for lead in the manufacture of storage batteries, he was unsuccessful in the first 20,000 experiments? When asked if he were discouraged and pessimistic, he said that his efforts had not been wasted because he had found 20,000 things that wouldn't work.

Intelligent risk-taking has nothing to do with foolhardiness or bravado, or with impulse and dumb luck. The constructive risk is always based on fact and preparation, and guided by reason. And this does not diminish the courage required to take the risk. For instance, Sir Edmund Hillary made the most painstaking preparation before his historic conquest of Mt. Everest, but it still took dauntless courage to brave the

face of the world's highest mountain.

Do some people actually enjoy bad luck? "Yes," say the behavioral experts. "There are some people who derive a perverse kind of pleasure from recounting their bouts with bad luck. These hard-luck story artists, who are constantly complaining and unloading their troubles and misfortunes whenever they can capture a willing audience, are termed psychic masochists." We have all, at some time or other, met this type of person. As the old saying goes, "He could be planted in a bed of roses and they would be the wrong color."

"Some people," wrote the Britisher Douglas Jerrold, "are so fond of ill luck that they run halfway to meet it."

As they recount their misfortunes, look closely. You might be amazed by the expression of pleasure on the face of the speaker.

Then again, some people don't actually "court" bad luck, they have a communication problem.

Luck is largely the result of taking appropriate action. When we are passive, when we don't take sufficient charge of our affairs, we are victims of all kinds of bad luck.

What is the basic "secret" that motivates much of our good luck? The possessor of a self-starting personality seizes opportunities that are actually

ignored by most people. This is true of the fellow who ends up being a corporation president, right down to the little grammar school boy who wins the trophy because he outran all his competitors. This makes good the old adage, "Even if the world owes you a living, you must be your own collector."

Strong self-motivation can flare up in a person at any time during his life, say the psychiatrists. They scoff at the person who insists that a man must be born with inner drive.

O. William Battalia, an executive who brings "luck" to people by giving them fantastic job offers, says: "Lucky people are gregarious. They talk to strangers and go out of their way to be friendly. They are the joiners, the meeters and the greeters. If they sit next to somebody on an airplane, they start a conversation."

All evidence seems to point to the fact that "Lady Luck" is, to a large extent, self-generated. If you want your luck to change...change your attitude. This maneuver can do much to guide your own destiny, making you one of the "lucky" ones.

And, no matter what has happened to you today, something unexpected and delightful—and maybe even glorious—could come blundering into your life tomorrow. ■



"It's happened! A bird in the hand is now worth only one-and-a-half in the bush."

Help!

The Elks Magazine postage fees have skyrocketed!

Help us cut costs by reporting any address change to your lodge secretary and The Elks Magazine Circulation Department.

Be sure to include lodge and membership number or an address label from the magazine. **Notice should be sent 6 to 8 weeks before your move.**

ATTACH ADDRESS LABEL HERE

New Address:

Name _____

Address _____

City _____

State _____ Zip _____

Lodge No. _____

Member No. _____

Mail to: Circulation Manager
The Elks Magazine
425 W. Diversey Pwy.
Chicago, IL 60614

11-9

the early

Mass Mayhem

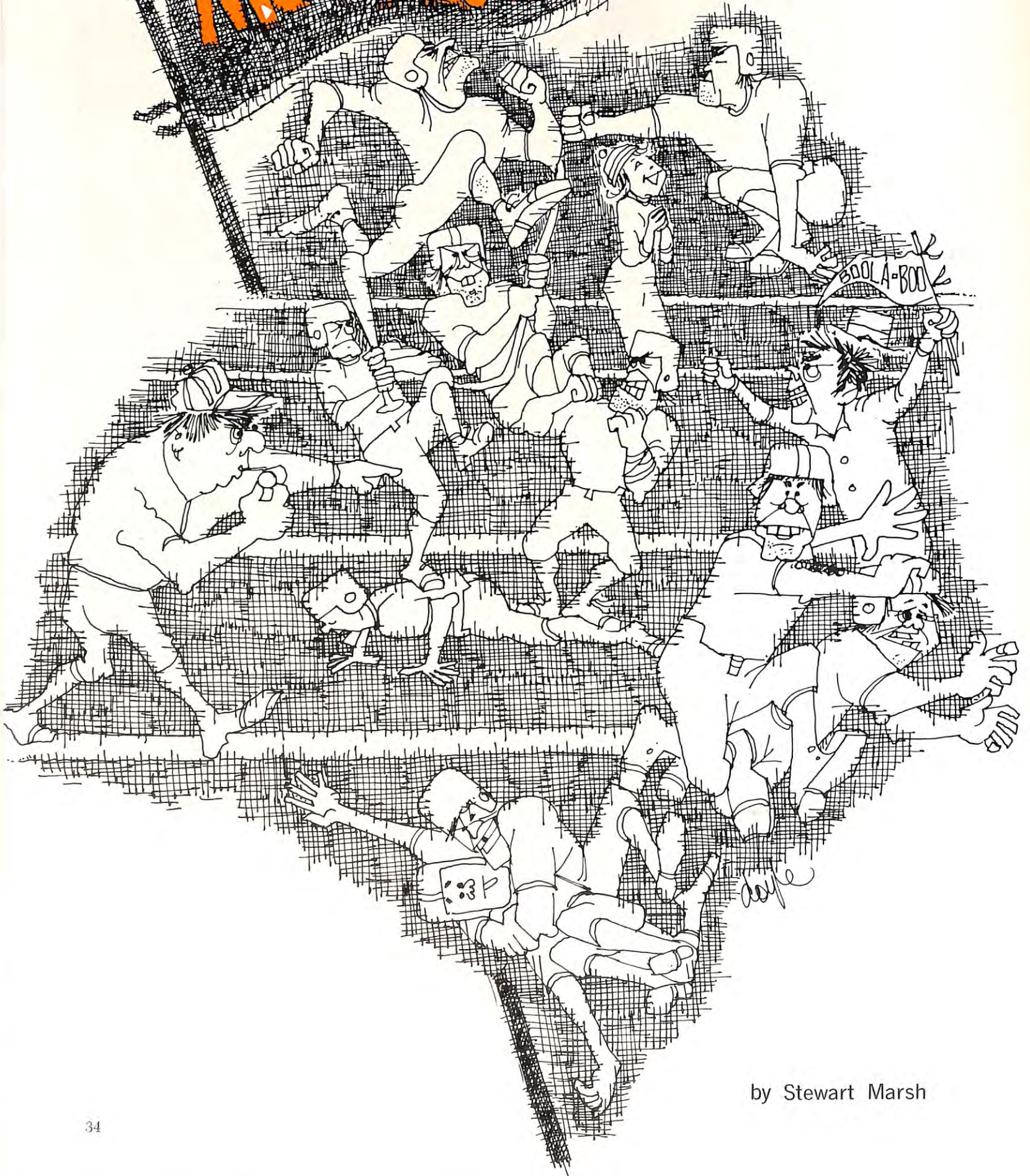

by Stewart Marsh

years of college football

Football players would slug opponents, jump on fallen foes, and kick each other more often than they kicked the football.

Long ago, when Michigan University sought to arrange a football game with Cornell University to be played at Cleveland, President Andrew D. White of Cornell put a stop to it. He is said to have fired off a reply, "I will not permit 30 men to travel 400 miles merely to agitate a bag of wind."

Although some took a dim view of it, intercollegiate football caught on rapidly. Youth fancied the sport and so did many alumni. The latter often became more rabid rooters than the students.

In 1969, the United States Postal Service issued a 6¢ stamp commemorating the 100th anniversary of intercollegiate football. The first game was between Princeton and Rutgers at New Brunswick, New Jersey, on November 6, 1869. However, it little resembled the game today. Similar to soccer, a round ball was advanced by kicking it.

A professor viewing the game admonished the players, "You will come to no Christian end." But dire prophecies did not quell youthful enthusiasm. Rutgers won the first game, and Princeton won the second a week later.

McGill University of Montreal, Canada, introduced intercollegiate Rugby football to the United States in a game played with Harvard University at Cambridge, Massachusetts, in 1874. The new running game, which featured an oval ball, soon became popular among the Eastern universities and spread to the colleges and universities throughout our country. Many changes were made over the years until, very slowly, it grew into modern-day football.

Playing conditions were often far from ideal. According to an old-timer, some of the early teams used a play which involved the dust formation. When asked what in the world this might be, he explained that the lines-

men picked up handfuls of dust on the sly. When the play began, they threw the dust into the eyes of the opposing linesmen!

A bit of moisture seemed the best defense against the dust formation. But if it rained too much, the field became a quagmire.

There was often a shortage of equipment, including footballs. A dog is said to have gotten hold of the football in one old-time game, biting so hard that the pigskin exploded. The game was interrupted while the home coach went into town to buy a new one.

When Purdue played Wabash in 1891, the score by the middle of the second half was Purdue 44, Wabash 0. Apparently having had it up to the teeth, a Wabash player grabbed the ball and ran off the field. Neither the player nor the ball could be found.

Drop-kicking had an important part in many of the old-time games. A tremendous dropkicker, Princeton's Alexander Moffat could kick with either foot. He kicked four goals against Harvard in 1882, two with each foot at difficult angles for an average of forty yards.

The "wedge" and the "turtle" or "turtleback" are said to have made their appearance in the 1880s. The ball carrier was hidden within a wedge of moving players, who formed the two-sided, V-shaped wedge; or he was hidden within the oval turtle.

William Walter "Pudge" Heffelfinger, who entered Yale in 1888, was able to cope with the flying wedge. Six-foot three and weighing over 200 pounds, he would take off like a long-jumper, double up his knees, and bang into the leader of the wedge full on. It is related that often the others in the wedge went down like bowling pins. A line destroyer, Heffelfinger seemed practically indestructible himself.

Frank Hinkey was another colorful Yale player. Scrawny, consumptive, and weighing only about 160 pounds, he played end like a demon. On defense, he seemed to glide through the opponent's line, tackling the ball carrier viciously. He was nicknamed the "Shadowy End" and the "Living Flame." Walter Camp was quoted as saying that Hinkey had more explosive energy than any athlete he ever saw.

Padded pants, cleats and helmets came into usage as the game grew older. In the 1890s, some linesmen had leather handles attached to their backs for the ball carrier to grasp and hang onto. If the thrust was stopped, two of the runner's teammates might pick him up and throw him skyward over the opposing linesmen. Sometimes the poor fellow lit on his head.

Some of the colleges played very rigorous schedules. The football team of the University of the South or Sewanee—a small Episcopal college in the mountains of Tennessee—traveled 2,500 miles, played and beat five major teams in 1899, all in the span of six days. They won 12 games that year, scoring 322 points to their opponents' 10, obviously giving their all for old Sewanee. In spite of this remarkable feat, the team was largely ignored by Eastern football experts.

Coaches, not uncommonly, had a number of tricks up their respective sleeves. When the Carlisle Indians, coached by Glen "Pop" Warner, played against Harvard in 1903, the Indians executed the notorious trick of stuffing the ball into the back of the runner's sweater.

Five years later, Harvard's new coach, Percy Haughton, learned that, when the Indians played against Syracuse, each Indian end and back had pads sewn to the front of their jerseys which were the color and shape of a football.

Free Details SUCCESS Breakthrough

An astonishing new system can help you acquire more wealth than you've ever dreamed of — with no risk on your part whatsoever. You need no capital to put this *dynamic new system* to work for you — nor must you give up your present job.

Developed by Ted Nicholas, one of America's most successful entrepreneurs, this system is guaranteed to work for you or its valuable secrets won't cost you a dime. Many users of Ted Nicholas' techniques are now making in excess of \$50,000 yearly, just by following these easy-to-understand guidelines.

Details are absolutely free. We'll even send along a FREE bonus worth \$6.00 when you ask to examine the system for 30 days without risk. Send no money! Simply write the words **Opportunities Unlimited** on a piece of paper, along with your name and address, and send it to: ENTERPRISE INSTITUTE, Dept. EK-9YU, 1300 Market Street, Wilmington, Delaware 19801. *Don't Wait — Mail Today!*

© Enterprise Institute, 1978

**Enterprise
Institute**

The University for Entrepreneurs

A non-profit organization

U-6001



Ride
up
and
down
stairs.

Install an Inclinette

Inclinette is the safe and easy way for the handicapped or elderly to ride up and down stairs with just a push of the button. And . . . it's tax deductible when recommended by a doctor.

SEND FOR FREE LITERATURE

Describes and illustrates Inclinette. Also, StairLIFT, the economy model, and "Elevette", the modern home elevator.

INCLINATOR COMPANY OF AMERICA

2222 Paxton St., Harrisburg, Pa. 17105
In business for over 50 years

PARTS for CHAIN SAWS

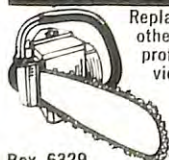

Replacement chain, guidebars, sprockets, other parts at substantial savings. Also professional sharpening equipment, service tools. All first quality. Guaranteed. FREE CATALOG. Stores, shops give sales tax number for special dealer information.

REPAIR PARTS
Erie, PA 16512

Box 6329

Dept. K-106



Before the Harvard game with the Indians, Warner was offered the conventional choice of one of three footballs. All three had been dyed a deep crimson to match the Harvard jerseys. "You win," said Warner; and on that occasion Harvard did.

The immortal James Francis "Jim" Thorpe played halfback at Carlisle early in the present century. On the football field, he did almost everything well. He was also an all-around athlete—some feel the greatest in recent memory.

Eligibility rules were a bit loose in old-time football, to say the least. One season's football coach at Syracuse is said to have become next season's captain at Cornell. In games played one year in the 1890s, the team members of the University of Oregon must have felt that they were seeing double, or rather triple. In three successive games with three different colleges, they found themselves competing against the same young man.

A University of Wisconsin player who graduated in 1892, is said to have still been playing in 1896, while a member of the faculty. Big colleges recruited players from small colleges. The use of professionals was not uncommon.

Gradually, the eligibility rules became stricter as time went along. Walter Camp (1859-1925) is often referred to as the "father of American football." He played halfback at Yale and later served as coach and athletic director. He became a member of the Rules Committee of Intercollegiate Football. An innovator, he suggested many of the playing and eligibility rules which came to be adopted.

In *Highlights of College Football*, Durand and Etter state: "Football in the Gay Nineties became a push-and-pull, strain-and-groan game, with accent on power rather than speed and deception. Open field playing was almost non-existent. Slugging with the fist was rampant. Broken jaws and noses, cracked ribs, limb fractures, and severe concussions were common. Players jumped on fallen foes. They kicked each other more often than they kicked the football. . ."

Describing the rough action which took place in one game, a newspaper reported that a player had kneed an opponent in his "epigastric region." It wasn't unusual to jump on the exposed

stomach of a fallen opponent with both feet. Violence seemed epidemic.

In spite of the brutality, however, football attracted increasing crowds and gate receipts. The first Tournament of Roses game was played in Pasadena on New Year's Day, 1902. Fielding H. "Hurry Up" Yost's great Michigan team demolished Stanford 49 to 0. From then on, post season and bowl games increased in number.

The growing football casualty lists became a national scandal. Public outcry by the *Nation* and the *New York Evening Post* led to the cancellation of the Army-Navy game in 1893. The Columbia University team of 1899 suffered so many injuries that its scheduled game with the Navy had to be cancelled. In 1903, 44 players were said to have died of football injuries. It became apparent to town and gown that something had to be done.

From 1901 to 1909, the White House was occupied by that strenuous American, Theodore "Teddy" Roosevelt. He professed that he didn't object to rough games, and he certainly didn't want to see colleges and universities molley-coddle young men. But he made it perfectly clear that he was very much opposed to brutality and foul play.

With typical energy, Roosevelt called a group of leading football coaches to the White House for a conference in 1905. They agreed that methods must be found to reduce the brutality in play.

Some of the coaches were afraid that, unless they took speedy action, Roosevelt might even seek to abolish intercollegiate football by executive decree.

Departed Brothers

PAST DISTRICT DEPUTY Sydney Flisser died recently. A member of Kingston, NY, Lodge, Brother Flisser served as District Deputy Grand Exalted Ruler for the East Central District in 1950-1951.

PAST DISTRICT DEPUTY Warren W. Strom of Miami, AZ, Lodge died August 24, 1979. Brother Strom served as District Deputy Grand Exalted Ruler for the South District in 1953-1954.

PAST SPECIAL DEPUTY Homer Wright of Oklahoma City, OK, Lodge died July 17, 1979. Brother Wright was District Deputy Grand Exalted Ruler for the Southwest District in 1968-1969. The following year, he served as Special Deputy Grand Exalted Ruler.

PAST SPECIAL DEPUTY John D. Quinn died September 10, 1979. A member of Sydney, OH, Lodge, Brother Quinn served as Special Deputy Grand Exalted Ruler from 1970 to 1972.

Playing rules were revised toward less violence. And the forward pass and inside kick were introduced, thus loosening up the game.

As the 20th century wore on, there were fewer outcries against intercollegiate football. But a number of academically-minded members of the faculty and the public continued to point out that colleges and universities ought to be in the business of providing a higher education for students, not promoting the "hoopla" of big-time football.

Among other things, critics charged that academic standards were often relaxed for football players. Thus, there was the story about the star halfback who was failing chemistry. The coach told the chemistry professor that the player was desperately needed to win the big game, and pleaded with him to give the halfback a special examination so that, hopefully, he would become academically eligible to play.

The professor agreed to give the special examination. There were two questions. The first was, "What color is blue vitriol?" The pigskin hero answered "Pink," which was incorrect. The second question was, "Do you know what H₂O means?" He answered "No," which was correct because he actually didn't know. So the professor gave him 50% credit and a passing mark on the examination.

Defenders of football cried "foul" to such tactics, stating that the relaxation of academic standards was the exception and not the rule. They maintained that football is good training for life, since it stresses teamwork as well as competitiveness.

Many college administrators found the gate receipts and the fame of football to be welcome, and these were enhanced, of course, by a winning team. It was also noted that football apparently helped to reduce the number of student riots and rebellions. Too, the game served to develop college spirit, and it was unquestionably exciting to watch or play.

A minority of people, however, held that overemphasis on intercollegiate football, and the commercialism of great stadiums and huge gate receipts, was a bad mistake. Because of it, colleges and universities had lost their moral leadership.

Early in the present century, many considered intercollegiate football, like the horseless carriage, to be a doubtful bet. For weal or for woe, however, the game has become more popular over the years. But with increasing demands by college women today for equal treatment in their sports—something the old-timers would have found incredible—fat football budgets may be in for a bit of shrinking. ■

Your Friends Just Won't Believe You're Not Wearing Real Diamonds!



Imagine! Gem stones so brilliant even expert jewelers have to study them to be sure they aren't real!

Crown Collection's incredible Magic Fire gems are that dazzling—that alive with flashing radiance and splendor. But they are yours for just a fraction of the cost of diamonds that can sell for \$1,000 per carat or more!

All Magic Fire stones are cut and polished by fine jewelry craftsmen to a full 58 facets like the best natural diamonds. And they're all magnificently set in 14 carat white or yellow gold.

Magic Fire gems are sold with a risk-free money back guarantee. Wear yours for 15 days. Hear the compliments. See how envious and impressed your friends are. If you're not absolutely delighted and satisfied in every way, return your Magic Fire jewelry. There's no obligation, no questions asked.

© 1979, The Crown Collection

Send for your FREE catalog of pendants, earrings, men's and women's rings. They all have the impact of fiery diamonds, the richness of solid 14 kt. gold at a cost that will amaze you. Mail the coupon below today and see the splendor of Magic Fire gems for yourself. EASY PAYMENT PLAN AVAILABLE.

CROWN COLLECTION, DEPT. EL11
509 Madison Avenue
New York, New York 10022

YES! I want to know more about saving hundreds of dollars on gems that are as brilliant and beautiful as diamonds. Send my FREE Magic Fire jewelry catalog today.

Print Name _____

Address _____

City _____

State _____

Zip _____

Now! Trim Tough Toenails - Even Ingrown Nails - Quick, Safe, Easy!



only \$3.99

These special toenail scissors have extra long shank for extra leverage... so you can cut the toughest toenails easily and safely.

Tough surgical-quality steel and narrow blade design lets you get to sensitive spots without irritating skin, even get in under ingrown toenails to remove them quickly.

Use these toenail scissors for regular trimmings, and you may never be bothered by painful ingrown toenails again. Great for pedicure, manicure, other household uses. Tough steel won't bend or break, blades stay keen for years. 4" long. Made in Germany. Order yours today. Only \$3.99.

90-DAY MONEY-BACK GUARANTEE

You must be delighted with your Toenail Scissors, or return them anytime within 90 days for prompt refund of purchase price (except shipping and handling).

mass marketing Assn.

10850 Riverside Dr., Dept. 105-32, N. Hollywood, Ca. 91602

MASS MARKETING ASSN., Dept. 105-32
10850 Riverside Dr., N. Hollywood, Ca. 91602

Please RUSH me _____ Pair(s) of Toenail Scissors #88986 at purchase price of just \$3.99 plus 75¢ shipping and handling.

SAVE! Send TWO pair at just \$6.99 plus \$1.00 shipping and handling.

Enclosed is my check or

money order for \$ _____
(Sorry, no C.O.D.'s - Ca. res. add sales tax.)

Print Name _____

Address _____

City _____

State _____

Zip _____

NEWS OF THE STATE ASSOCIATIONS

One important proposal approved by Georgia Brothers during their state conclave was the increase of membership dues. Over 600 people met at Jekyll Island for the June 6-9 convention. A major event of the business session was the installation of new officers. SP William Whaley of Atlanta-Buckhead Lodge will head the state association for the new lodge year. Brother Whaley's assisting officers include President-Elect G. Doug Whitaker, Griffin; Vice Presidents Walter Campbelle, Augusta; Robert Carter, Valdosta; James Nalley, Columbus-Fort Benning; Edwin Samuelson, Atlanta-Buckhead; and Secy.-Treas. Roy Jaeckel, Albany.

PGER Robert Pruitt delivered a speech during the meeting. He challenged the conventioners to work for increased membership for the coming year. The PGER commended Georgia Brothers for the enthusiasm they have exhibited for the Elks Aidmore Children's Home, the state major project.

Various awards were presented to lodges and individuals. Dalton Lodge earned the ritualistic award, and the Guy Tyler Award for ritualistic high score went to J. D. Hagen of Dalton Lodge. The Secretary of the Year Award was proffered to Secy. Charles Foster Jr. of Albany Lodge, and the Americanism trophy was bestowed upon Atlanta-Buckhead Brothers. Youth Chm. Alex McFadden and Scholarship Chm. Andreas Olsen presented scholarships and awards to the winning youngsters. In-

coming VP Edwin Samuelson delivered the eulogy for the memorial service.

Two mid-winter meetings, one January 12-13 in Augusta and another March 8-9 in Atlanta, were planned. Jekyll Island was again selected as the location of the June 11-14, 1980, conclave.

Prizes and gifts were presented during Monte Carlo Night held on the opening day of the Virginia State Elks Association 70th Annual Convention. Other activities arranged for the 434 conventioners were the annual golf tournament played at Winton Country Club, a breakfast for ERs and PERs as well as one for state officers and guests. The President's Ball was a semi-formal event held Saturday evening.

Then-GER Leonard Bristol, PGER John Walker, Grand Trustee Alex Harman Jr., SDGER B. M. Scott, PDD William Goodwyn Jr. of North Carolina, and Mayor Elliott Shearer of Lynchburg were all on hand for the June 8-10 conclave. Outgoing SP Robert Pannell welcomed the dignitaries to the meeting hosted by Lynchburg Lodge. SP Pannell presided over the business sessions and introduced the new officers. The slate of state officials includes SP Donald Netschke Jr., Alexandria; Vice Presidents Walter Edmonds, Portsmouth; Henry Self, Martinsville; Raymond Orndorff Jr., Manassas; Secy. Charles Curtice, Petersburg; and Treas. C. T. Duffee, Norfolk.

Reports made during the conclave included one presented by Brother Charles Ebert, treasurer of the Virginia Elks Boy's Camp Trust Fund, who informed the conventioners that there is \$14,230.77 in the major project fund. Major Projects Chm. Paul Kelly reported that renovation of the camp neared completion. The season opened with 109 campers. Chm. H. Danny O'Donnell reported on the success of the "Hoop Shoot" program.

Rev. Thomas Mabe was the orator for the memorial service. The ritualistic contest was won by Arlington-Fairfax Lodge, and the awards were presented by SDGER B. M. Scott. Among the resolutions presented by Brother Benjamin Campbell was one altering the format of the ritualistic contest. It was reported that the Scholarship Committee had a successful year. Nineteen students will receive National Foundation Scholarships, and two students will receive state association scholarships of \$500 and \$250. Reports of the charity programs indicated a gain over the past year.

A ritualistic clinic was scheduled for March 9, 1980. Virginia Brothers plan to hold their 71st state conclave June 27-29, 1980, in Arlington-Fairfax.

Thirty-four lodges were represented at the 50th Connecticut Elks Association Convention held in East Hartford, June 8-11. More than 400 Elks and Elks' ladies were joined by SDGER Arthur Roy, past GL committeeman, GL Committeeman Edwin Maley, and New Hampshire's SDGER Ronald Simpson, past GL committeeman.

The Standing Committee and the state officers presented reports of the year's accomplishments during Saturday's business session. The new budget was approved, and amendments to the bylaws were adopted. A program to expand participation in the major project, support of Newington Children's Hospital, was implemented and includes a commitment to raise \$450,000 for the hospital. Consideration was given to a plan for redistricting the state. Once agreed upon by all the districts, the plan will be presented to the Board of Grand Trustees.

VP Douglas Murray delivered an address for the memorial service observed by the conventioners. Congratulations were offered to the new officers, includ-

Georgia's incoming SP William Whaley (front, center) joined newly installed officers (from left) Tiler Eugene Coughlin, Chap. Keith Wortman, Pres.-Elect Douglas Whitaker, VPs Bobby Carter, James Nalley, and Edwin Samuelson, and Sgt.-at-Arms Curtis Melton during a break in the convention proceedings.



ing SP Fran Reinholz, East Hartford; Vice Presidents Alan Lyon, Willimantic; Joseph Palmer, Naugatuck; John Goodman Jr., Wethersfield-Rocky Hill; Douglas Murray Jr., Milford; Secy. Thaddeus Pawlowski, Norwich; and Treas. Edward Szewczyk, Enfield. Brother Reinholz was honored at the President's Ball, which included a dinner enjoyed by all the conventioners.

The winner of the ritualistic contest held during the June 7-10 Pennsylvania Elks State Association Convention was the Bangor Lodge team. Congratulations were offered to Bangor Brothers by PGERs Willis McDonald and Homer Huhn, Jr. Over 1,000 Elks and Elks' ladies joined the dignitaries for the conclave held in Philadelphia.

Elected to head the state association was SP Robert Mitchell of Johnstown Lodge. Brother Mitchell's assisting officers are Vice President Harold Sweeney, Lock Haven; Secy. Howard Schran, Etna; and Treas. Harry Stoops, Apollo. The officers will conclude their terms when Pennsylvania Brothers reconvene June 12-15, 1980, at the Seven Springs Mountain Resort in Champion. A fall workshop in Hershey precedes the summer conclave.

The business session included reports of the state major project, the Cerebral Palsy Home Service Program, and of the National Foundation Committee. Pennsylvania Brothers raised \$288,935.83 for the major project. This amount surpassed their goal. A total of \$90,525.46 was raised for the National Foundation this year.

Thousands of local residents watched the 4½-hour Elks parade through Wildwood, New Jersey, where the state convention was held. The parade included more than 15,000 marchers, bands, and floats. Over 7,000 Brothers were joined by their wives and friends at the June 7-10 conclave.

PGER William Jernick, who is celebrating his 50th year as an Elk, 40 years as a PSP, and 25 years as a PGER, was a special guest at the meeting. Brother Jernick led the installation of state officers. Congratulations were offered to SP Sol Goldberg, Watchung Hills; Vice Presidents Glen Utley, Jack DeVries, Edward Lyons, David Carswell, Louis Szabo, Lawrence Forgas, Richard Fitzgeorge, Matthew Cornelisse, Kenneth Sommers, William Schwalenberg, Leo Grossman, and Joseph Morris; Secy. Obert Stetter, Asbury Park; and Treas. Fred Stevens, Colonia.

Reports were made by all the state committees during Friday's business session. The Brothers approved a budget of \$33,200, and 60,000 is the membership goal set for the coming year.



PGER William Jernick (left) and SP Sol Goldberg were among the New Jersey conventioners who viewed the 4½-hour parade through Wildwood.

It was reported that Elks' Camp Moore, the state major project, was ready for a full summer schedule and 600 campers who registered for the season. Changes in the bylaws concerning the method of electing the state president were confirmed. Scholarships were presented, and the Poster Children were introduced.

The conventioners enjoyed the President's Reception Party and a formal dinner. They also observed the presentation of various awards for participation in the state programs. New Jersey Brothers selected Wildwood once again for the site of next year's June 6-9 convention.

The ritualistic team members of Champaign-Urbana Lodge were congratulated for their victory in the ritualistic contest held during the Illinois Elks Association Convention. Over 800 conventioners attended the May 18-20 conclave held in Springfield. Among the social events enjoyed by the Elks and Elks' ladies were the President's Banquet, a ladies party, and a social hour.

The convention business sessions included the Past State Presidents' Dinner Meeting, during which the Advisory Committee convened. Organizational meetings were held for the Athletic, Crippled Children, and Publications commissions. The highlight of the business meetings was the installation

New state officers of Illinois were congratulated by the conventioners, including their wives. On hand after the installation ceremonies were (from left) Treas. William and Wanda Grimes, VP William and Betty Leas, Marian and SP George Schanzle, VP Robert Sabin, and Milly and Secy. Irwin Stipp, GL committeeman.

of new officers. Illinois's new SP is George Schanzle of Carmi Lodge. Other state officials are Vice Presidents William Leas, Decatur; Robert Sabin, Arlington Heights; Secy. Irwin Stipp, Springfield; and Treas. William Grimes, Mattoon.

The Brothers voted to hold only two meetings per year as of 1980. These sessions will be an annual and a fall conclave; other gatherings may be scheduled by the state president when necessary. Incoming SP George Schanzle plans to stress the importance of membership gain and the prevention of lapsation during his term as head of the state association. Peoria was selected as the location for next year's May 23-25 conclave, and a mid-winter meeting was planned for February 1-3 in Champaign.

Massachusetts Brothers decided upon some important new steps to be taken towards an increase in membership when they met at Bretton Woods Resort in New Hampshire. They also resolved to increase their activity in the National Foundation program. Grand Trustee Alfred Mattei encouraged the Exalted Rulers and District Deputy Grand Exalted Rulers present at the conclave to expand their involvement in the state association and Grand Lodge programs.

The June 8-10 state convention was attended by 1,100 people, including GL Committeeman Arthur Kochakian and Dominic Dululio, chairman of the GL Americanism Committee. The conventioners had the opportunity to play mini-golf and to win awards presented by outgoing SP Edward Lynch. Tours and games were also available for the enjoyment of the Elks' ladies and guests. Competitors in swimming and

(Continued on next page)

News Of The State Associations

diving contests took advantage of the resort's facilities, which also included a nightclub with entertainment and music for dancing in the evenings. The Billerica Lodge Color Guard and Springfield Lodge's band paraded through the resort grounds. The President's Social Hour was a reception held for all the Brothers and guests.

The business sessions included a report of the *Massachusetts Elks News*, which is published every two months and has a circulation of 57,000, and the planning of regional meetings. A report was delivered concerning the state major project, the Massachusetts Elks Scholarship Fund and Charity Awards. Scholarships amounting to \$63,000 were awarded to students, and \$78,000 was donated to various organizations in the form of Charity Awards.

SP William Kerrigan of Hudson Lodge will lead Massachusetts Brothers in the business of the state association for the 1979-1980 lodge year. Also installed during the conclave were Vice Presidents Angelo Themes, Beverly; Joseph Silvia Jr., Taunton; James Consolmagno, Worcester; Robert Blomquist, Arlington; Secy. James Colbert, Somerville; and Treas. Donald Podgurski, Norwood.

Bretton Woods, NH, was again chosen for the site of next year's June convention.

The honored guest at the Vermont Elks Association Convention was Grand Trustee Alfred Mattei. Brother Mattei addressed 176 Vermont Elks during the June 15-17 conclave held in Bretton Woods, NH. Other dignitaries who attended the convention were SDGER Raymond Quesnel, then-GL Committeeman Carl Quesnel, and then-DDGERs Kenneth Kiser and Stephen Kendrick.

Recognition was given to various lodges and individuals for their accomplishments of the past year. The Past President's Plaque went to outgoing SP Walter Barcomb, and a plaque was awarded to Bert Fraser of Montpelier Lodge for organizing the Annual State Sports Award Banquet, the proceeds of which go to the major project, for 14 years. Then-DDGERs Kenneth Kiser and Stephen Kendrick received plaques of appreciation, and Bennington Brothers were awarded a membership plaque. The Ray Quesnel Rotating National Foundation Trophy was earned by St. Johnsbury Lodge. Sports awards were proffered to Bellows Falls Lodge for their championships in golf and cribbage, to Windsor Lodge for their

wins in candlepin bowling and eight ball pool, and to St. Johnsbury Brothers for their tenpin bowling accomplishments.

During the business sessions, it was reported that the state major project, Silver Towers Camp for Retarded Children, had a successful year. Vermont Brothers' goal of raising \$20,000 for the National Foundation was reached. A motion to increase the per capita tax by five cents was proposed and seconded. If approved at the next state conclave, the increased income will benefit the ritualistic program. A short speech was given by Brother Joseph Brady, who has attended all of the 52 state conventions.

Rutland Lodge's Allan Merritt heads the slate of new officers, which includes Vice Presidents Larry Beswick, Bellows Falls; Charles Lavalla, Brattleboro; John Carroll, St. Johnsbury; Secy. Roger Sheridan, Montpelier; and Treas. Owen Williams, Bellows Falls. The new state officers will conclude their terms in May of next year when Vermont Elks meet in the Catskill Mountains for their 53rd convention, which will be hosted by Rutland Lodge.

Among the highlights of the Florida State Elks Association Convention was the report on the major project, the Harry-Anna Crippled Children's Hospital in Umatilla. Administrator James Oliver reported that 260 children were treated this past year at an average cost of \$4,600 per child. In addition to the hospital, several outpatient clinics served more than 1,600 youngsters. The Harry-Anna Trust Fund was augmented by \$654,000 in contributions.

Over 1,700 people registered for the May 18-19 conclave held at the Orlando Hyatt House near Kissimmee, FL. Outgoing SP R. Edward Royal presided over the meeting. The guests of honor included PGER Willis and Elizabeth McDonald and PGER William Wall. The dignitaries congratulated Richard Robinson of Sebring Lodge upon his installation as president. Brother Robinson's assisting officers are Vice President-at-large Harry Baruch, South Miami; Vice Presidents Joseph Bryant, Fort Walton; George Dominianni, Starke; Lawrence Cline, Cocoa; James Oliver, Eustis; William Fields, Tampa; Joseph Ziegler, New Port Richey; William Bostwick, Charlotte County; David Riley; Lewis Cote, Hollywood West; Marshall Dunn, Coral Gables; Secy. Ben Brown, Eustis; and Treas. Frank Holt, Miami.

The conventioners observed a memorial service, which included a special eulogy given by PDD J. D. Cooke for the late Past GL Committeeman Julian Smith. Norman O'Brien, chairman of the GL State Associations Committee,

delivered a memorial address. Social activities enjoyed by the conventioners included the President's Banquet and Ball. The ritualistic contest was observed by those at the conclave. Congratulations were offered to the team from Tallahassee, who will defend their championship next year in May when the Brothers reconvene at Miami Beach for the state convention.

French Lick, Indiana, was the site of the 1979 Indiana Elks convention. Approximately 1,000 Elks and their ladies attended. Then-GER Leonard Bristol was the honored speaker at the opening banquet, and PGER Frank Hise was the principal speaker at a second banquet. Also in attendance were Mrs. Ginny Bristol, Mrs. Betty Hise, PGER Glenn Miller, Grand Secy. Stanley and Marge Kocur, Grand Treas. William and Janet Collisson, and GL Committeeman Sam and Ellen Fitzsimmons.

Among presentations made during the convention were the state awards to winners of the Most Valuable Student Contest, including a \$10,000 scholarship to first-place winner Kenny McCleary. Mr. McCleary went on to win second place in the national scholarship program. Wabash Lodge won the ritualistic contest. South Bend Lodge placed second, and Jeffersonville, third.

Two checks for the support of medical training and research were presented during the convention proceedings. PSP Thomas E. Burke, major projects chairman, gave a check of \$55,000 to Dr. Steven Beering, dean of the Indiana University School of Medicine. Brother Burke presented a second check, for the amount of \$45,000, for cancer research to Dr. James Morre, associate professor of biology and medicinal chemistry at Purdue University.

It was announced during the convention that there has been a gain in membership in the state of Indiana, and that several lodges are in the process of constructing new lodge facilities. GL Committeeman Sam Fitzsimmons conducted an officer's training program for Exalted Rulers and Esteemed Leading Knights of Indiana's lodges.

The new state officers elected were SP H. Eugene Milliron of Indianapolis Lodge; Vice Presidents William Booher, Logansport; Robert Gillan, Linton; Russell Phillips, Jeffersonville; Pat Blaugher, Marion; Warren John, Auburn; Treas. J. L. J. Miller, East Chicago; and Secy. C. L. Shideler, Terre Haute. Brother Shideler was elected to this position for the 40th consecutive year.

The Indiana Elks will host a fall meeting in Indianapolis. The site of next year's convention will again be French Lick, where the Brothers will convene June 5-8. ■



Grand Lodge Officers And Committees For 1979-1980

GRAND EXALTED RULER

ROBERT GRAFTON (North Palm Beach, Florida, Lodge No. 2069)
Box 3425, West Palm Beach, Florida (33402)

GRAND ESTEEMED LEADING KNIGHT

FRANK A. DORLARQUE, Anaconda, Montana, Lodge No. 239
317 East Third Street (59711)

GRAND ESTEEMED LOYAL KNIGHT

ART M. OLSON, Ely, Nevada, Lodge No. 1469
9 Elysium Drive (89301)

GRAND ESTEEMED LECTURING KNIGHT

ELMO M. ANGELE, Lakeview, Oregon, Lodge No. 1536
Route #6, Box 880 (97630)

GRAND SECRETARY

STANLEY F. KOCUR (East Chicago, Indiana, Lodge No. 981)
2750 Lake View Avenue, Chicago, Illinois (60614)

GRAND TREASURER

WILLIAM H. COLLISSON, Linton, Indiana, Lodge No. 866
Box 351 (47441)

GRAND INNER GUARD

RONALD E. SIMPSON, Portsmouth, New Hampshire, Lodge No. 97
287 Myrtle Avenue (03801)

GRAND TILER

WENDELL G. WHITE (Muscatine, Iowa, Lodge No. 304)
Box 755, Wilton, Iowa (52778)

GRAND ESQUIRE

To be appointed.

GRAND CHAPLAIN

REV. B. A. ERPEN (Borger, Texas, Lodge No. 1581)
Box 351, Wellington, Texas (79095)

SECRETARY TO GRAND EXALTED RULER

CARL VAUGHN (North Palm Beach, Florida, Lodge No. 2069)
Box 3425, West Palm Beach, Florida (33402)

BOARD OF GRAND TRUSTEES

FRANK O. GARLAND (Chairman), (Centralia-Chehalis, Washington,
Lodge No. 2435) Box 808, 505 West Main Street,
Centralia, Washington (98531)

A. LEWIS HEISEY (Vice-Chairman), (Middletown, Pennsylvania,
Lodge No. 1092) 244 South Market Street,
Elizabethtown, Pennsylvania (17022)

MARVIN M. LEWIS (Approving Member), Brawley, California, Lodge No. 1420
522 Main Street (92227)

ALEX M. HARMAN, JR. (Secretary), Pulaski, Virginia, Lodge No. 1067
Box 1438 (24301)

LARRY McBEE (Home Member), New Lexington, Ohio, Lodge No. 509
Box 567, 106 South Main Street (43764)

JOHN T. TRAYNOR (Pension Member), Devils Lake, North Dakota,
Lodge No. 1216, Box 838, 601-12th Avenue (58301)

ALFRED J. MATTEI (Building Applications-East), Worcester, Massachusetts,
Lodge No. 243, 313 Park Avenue (01609)

Area 1: Connecticut, Maine, Massachusetts, New Hampshire,
New York, Rhode Island, Vermont

Area 2: Maryland-Delaware-District of Columbia, New Jersey,
Pennsylvania, West Virginia

Area 3: Alabama, Arkansas, Canal Zone, Florida, Georgia, Kentucky,
Louisiana, Mississippi, Missouri, North Carolina, Puerto Rico, South
Carolina, Tennessee, Virginia

Area 4: Indiana, Michigan, Ohio

ROBERT L. SMITH (Building Applications-West), (McAlester, Oklahoma,
Lodge No. 533) Box 316, Indianola, Oklahoma (74442)

Area 5: Illinois, Iowa, Minnesota, North Dakota, Wisconsin

Area 6: Colorado, Kansas, Montana, Nebraska, New Mexico,
Oklahoma, South Dakota, Texas

Area 7: Arizona, California, Guam, Hawaii, Nevada,
Republic of the Philippines

Area 8: Alaska, Idaho, Oregon, Utah, Washington, Wyoming

GRAND FORUM

WILLIAM J. STEINBRECHER (Chief Justice), (New Hyde Park, New York,
Lodge No. 2107) 500 Old Country Road,
Garden City, New York (11530)

SIDNEY J. NICHOLSON, Florence, Oregon, Lodge No. 1858
Box 146 (97439)

ROBERT B. WEBB (Santa Ana, California, Lodge No. 794)
1427 Bank of America Tower, One City Boulevard, West;
Orange, California (92668)

DONALD F. NEMITZ, St. Charles, Missouri, Lodge No. 690
1423 Heritage Landing (63301)

EDWARD W. CONNOLLY, Livingston, New Jersey, Lodge No. 1855
35 North Livingston Avenue (07039)

COMMITTEE ON JUDICIARY

RAYMOND V. ARNOLD (Chairman), Jackson, Michigan, Lodge No. 113
Box 570 (49204)

States: IN, KY, MI, OH, VA

EUGENE F. COSTELLO, Denver, Colorado, Lodge No. 17
750 Petroleum Club Building, 110-16th Street (80202)

States: CZ, CO, NM, OK, TX, WY

ROBERT J. SABIN, Arlington Heights, Illinois, Lodge No. 2048
1040 South Arlington Heights Road (60005)

States: IL, IA, KS, MN, NE, ND, SD, WI

SEYMOUR NATHANSON, Portland, Maine, Lodge No. 188
480 Congress Street (04101)

States: CT, ME, MA, NH, NY, RI, VT

LESTER C. HESS, JR., Wheeling, West Virginia, Lodge No. 28
1226 Chapline Street (26003)

States: MD, DE, DC, NJ, PA, PR, WV

WAYNE A. WESTOVER, JR. (Richmond, California, Lodge No. 1251)
4409 Dam Road, El Sobrante, California (94803)

States: AZ, CA, GU, HI, NV, RP

LAWRENCE E. HOFFMAN, Miami Beach, Florida, Lodge No. 1601
4477 Adams Avenue (33140)

States: AL, AR, FL, GA, LA, MS, MO, NC, SC, TN

FELIX REA, Ephrata, Washington, Lodge No. 1816
Box 1113 (98823)

States: AK, ID, MT, OR, UT, WA

AMERICANISM COMMITTEE

DOMINIC P. DULULIO (Chairman), (Leominster, Massachusetts,
Lodge No. 1237) 324 Maravista Avenue; Teaticket, Cape Cod,
Massachusetts (02536)

J. W. WORTMAN, JR., Albany, Georgia, Lodge No. 713
2027 Whispering Pines Road (31707)

SAM FITZSIMMONS, Van Wert, Ohio, Lodge No. 1197
Box 573 (45891)

HARRY J. CARNEY, JR., Perry, Iowa, Lodge No. 407
1305 Second Street (50220)

VINCENT R. COLLURA, Lincoln, Nebraska, Lodge No. 80
Box 83086 (68501)

THOMAS E. JONES (Gateway (Portland), Oregon, Lodge No. 2411)
2136 N. E. 134th Place, Portland, Oregon (97230)

DONALD W. LUCE, Richmond, California, Lodge No. 1251
3928 Clinton Avenue (94805)

EDWARD VAN VOOREN, Wayne, New Jersey, Lodge No. 2181
292 Pine Lakes Drive East (07470)

AUDITING AND ACCOUNTING COMMITTEE

ROBERT C. GRANT (Chairman), Cullman, Alabama, Lodge No. 1609
1604 Catoma Drive, N.E. (35055)

Area No. 3: AL, AR, CZ, FL, GA, KY, LA,
MS, MO, NC, PR, SC, TN, VA

JOSEPH M. MATTIAS, West Warwick, Rhode Island, Lodge No. 1697
1499 Main Street (02893)

Area No. 1: CT, ME, MA, NH, NY, RI, VT

JAMES L. DOMPIERRE, Negaunee, Michigan, Lodge No. 1116
1008 Pine Street (49866)

Area No. 4: IN, MI, OH

JAMES P. EBERSBERGER, Latrobe, Pennsylvania, Lodge No. 907
942 Terrace Drive (15650)

Area No. 2: DE, DC, MD, NJ, PA, WV

A. W. KOWALCHYK, Wausau, Wisconsin, Lodge No. 248
311 Second Street (54401)

Area No. 5: IL, IA, MN, ND, WI

JOHN J. PATANE (Auburn, Washington, Lodge No. 1808)
Box 5211, Kent, Washington (98031)

Area No. 8: AK, ID, OR, UT, WA, WY

KENTON NASH, Vallejo, California, Lodge No. 559
244 American Canyon Road, Space 158 (94590)

Area No. 7: AZ, CA, GU, HI, NV, RP

HOWARD A. TRINGLEY (Boulder, Colorado, Lodge No. 566)
635 South Alton Way, Apt. 5D, Denver, Colorado (80231)

Area No. 6: CO, KS, MT, NE, NM, OK, SD, TX

COMMITTEE ON CREDENTIALS

HOWARD W. NUNEZ (Chairman), Albuquerque, New Mexico, Lodge No. 461
3020 Jardin Plaza, Northeast (87110)

PAUL W. BRUBAKER, Lancaster, Pennsylvania, Lodge No. 134
1914 Millersville Pike (17063)

ROBERT E. PAINE, Honolulu, Hawaii, Lodge No. 616
7021 A Kalaniana'ole Highway (96825)

RICHARD H. ABLER (St. Joseph, Michigan, Lodge No. 541)
26110 South Shore Drive, Mendon, Michigan (49072)

GILBERT A. CURRIER (Hartford, Vermont, Lodge No. 1541)
13 Estabrook Circle, West Lebanon, New Hampshire (03784)

HARVEY R. PEARSON, Moline, Illinois, Lodge No. 556
3123-11th Avenue A (61265)

THOMAS THOMPSON (New Orleans, Louisiana, Lodge No. 30)
#3 Laux Manor Drive, Metairie, Louisiana (70003)

EDWARD B. YOUNG, Riverton, Wyoming, Lodge No. 1693
911 West Fremont (82501)

GOVERNMENT RELATIONS COMMITTEE

YUBI G. SEPAROVICH (Chairman), (Sacramento, California, Lodge No. 6)
5309 Wedge Circle, Fair Oaks, California (95628)

JAMES W. DAMON (John Day, Oregon, Lodge No. 1824)
Box 38, Mt. Vernon, Oregon (97865)

MICHAEL J. HOBLOCK, JR. (Colonic, New York, Lodge No. 2192)
Apartment 1G, Denise Drive, Latham, New York (12110)

RICHARD E. MARTIN, St. Joseph, Missouri, Lodge No. 40
1814 Lovers Lane Terrace (64505)

ROBERT D. MOORE, Fairfield, Iowa, Lodge No. 1192
805 South Second (52556)

LEWIS L. NURNBERGER (Manistee, Michigan, Lodge No. 250)
849 Thorntree Boulevard, Jackson, Michigan (49203)

DONALD O. OESTERLING (Butler, Pennsylvania, Lodge No. 170)
Westwood Village, 851 Melissa Court, Enola, Pennsylvania (17025)

JAMES M. SANDLIN, Duncan, Oklahoma, Lodge No. 1446
Box 622 (73533)

LODGE ACTIVITIES COMMITTEE

ALVIN A. EHRLICH (Chairman), Orlando, Florida, Lodge No. 1079
Box 1423 (32802)
PETER T. AFFATATO, Hicksville, New York, Lodge No. 1931
Box 32 - 57 North Broadway (11802)
STANLEY O. MASCOE, Indianapolis, Indiana, Lodge No. 13
2531 Union Street (46225)
JACK L. RORDAN, Palm Springs, California, Lodge No. 1905
634 Vista Oro (92262)
OLLEY G. ANDERSON, Austin, Texas, Lodge No. 201
6205 Ledge Drive (78750)
JAMES B. ROBERSON (Mount Adams (White Salmon), Washington,
Lodge No. 1868) Box 587, Bingen, Washington (98605)
JAMES ST. GEORGE, Lyndhurst, New Jersey, Lodge No. 1505
Box 147 (07071)
RICHARD J. STROPES, Pekin, Illinois, Lodge No. 1271
2117 Sunset Drive (61554)

NEW LODGE COMMITTEE

EARL W. NOWELL (Chairman), Fresno, California, Lodge No. 439
1646 North Pacific Avenue (93705)
ROBERT E. SMITH, Nashua, New Hampshire, Lodge No. 720
31 Charlotte Avenue (03060)
E. PAUL HOWARD, Alliance, Ohio, Lodge No. 467
2418 South Seneca Avenue (44601)
EUGENE D. MAYER, Pierre, South Dakota, Lodge No. 1953
Box 280 (57501)
TED BUTCHER (Centralia-Chehalis, Washington, Lodge No. 2435)
114 North Pearl Street, Centralia, Washington (98531)
FLOYD L. SPENCE, Crookston, Minnesota, Lodge No. 342
609 Hunter Street (56716)
RICHARD W. SQUIRES (Dover, New Jersey, Lodge No. 782)
10 Wetmore Drive, Denville, New Jersey (07834)
THEODORE ZIMMER (Newport, Kentucky, Lodge No. 273)
3920 Holman Circle, Cincinnati, Ohio (45236)

RITUALISTIC COMMITTEE

DALE W. BLANTON (Chairman), San Rafael, California, Lodge No. 1108
269 Blackstone Drive (94903)
TED CALLICOTT, Paris, Tennessee, Lodge No. 816
Tyson Avenue (38242)
JAMES W. ANDERSON, Kearney, Nebraska, Lodge No. 984
2300 - 5th Avenue (68847)
G. LESTER Von BARGEN, Lewiston, Idaho, Lodge No. 896
1202 - 11th Avenue (83501)
EARL J. CASE, Pottstown, Pennsylvania, Lodge No. 814
224 Diamond Street (19464)
JOSEPH DeLITTA (Mamaroneck, New York, Lodge No. 1457)
818 Fenimore Road, Larchmont, New York (10538)
FRED GILMORE, Linton, Indiana, Lodge No. 866
Box 242 (47441)
ROBERT F. KAUPHUSMAN, Jamestown, North Dakota, Lodge No. 995
Box 1384 (58401)

STATE ASSOCIATIONS COMMITTEE

NORMAN P. O'BRIEN (Chairman), (South Miami, Florida, Lodge No. 1888)
1525 Mercado, Coral Gables, Florida (33146)
IRWIN H. SHIPP, Springfield, Illinois, Lodge No. 158
Box 2162 (62705)
ROBERT L. EARNEST, Russell, Kansas, Lodge No. 1715
Box 72 (67665)
MICHAEL J. DEIN, Tucson, Arizona, Lodge No. 385
2636 North Willow (85719)
ARTHUR D. KOCHAKIAN, Haverhill, Massachusetts, Lodge No. 165
31 Marlon Street (01830)
C. J. WILKINS (Tillamook, Oregon, Lodge No. 1437)
8240 Cedar Street, Rockaway, Oregon (97136)
HERBERT M. BRAUTZSCH, Fort Wayne, Indiana, Lodge No. 155
Box 566 (46801)
MARLAND DEEN, Waldorf, Maryland, Lodge No. 2421
Route 4, Box 281 (20601)

YOUTH ACTIVITIES COMMITTEE

B. J. BYBEE (Chairman), Idaho Falls, Idaho, Lodge No. 1087
1430 Antares Drive (83401)
EDWIN I. MALEY (New Haven, Connecticut, Lodge No. 25)
650 Mix Avenue, Apartment 2J, Hamden, Connecticut (06514)
JOE D'ANGELO, Phoenix, Arizona, Lodge No. 335
3321 West Turney (85017)
NICK M. KOVIC, Warren, Ohio, Lodge No. 295
1105 Willard, Southeast (44484)
AL F. HUMPHREY, Fort Madison, Iowa, Lodge No. 374
609 Ninth Street (52627)
W. ERNEST BELL, Durham, North Carolina, Lodge No. 568
2701 Sparger Road (27705)
LEONARD E. BENNETT, Rifle, Colorado, Lodge No. 2195
Box 683 (81650)
C. BENNETT DRY, Berwick, Pennsylvania, Lodge No. 1138
R. D. No. 4, Box 447 (18603)

ELKS NATIONAL "HOOP SHOOT"® FREE THROW CONTEST

EMILE J. BRADY (National Director), Danville, Pennsylvania, Lodge No. 754
Box 153 (17821)
GERALD L. POWELL (National Advisor), Peru, Indiana, Lodge No. 365
Box 520 (46970)

PARDON COMMISSION

WILLIAM J. STEINBRECHER (Chairman), (New Hyde Park, New York,
Lodge No. 2107) 500 Old Country Road,
Garden City, New York (11530)
RAYMOND V. ARNOLD, Jackson, Michigan, Lodge No. 113
Box 570 (49204)
ARCH WALLACE, JR. (Commissioner), Greenville, South Carolina,
Lodge No. 858, 16 Astor Street (29615)

ELKS NATIONAL MEMORIAL AND PUBLICATION COMMISSION

WADE H. KEPNER (Chairman), Wheeling, West Virginia, Lodge No. 28
1308 Chapline Street (26003)
R. LEONARD BUSH (Vice-Chairman), (Inglewood, California, Lodge No. 1492)
Box 238, El Toro, California (92630)
EDWARD W. McCABE (Treasurer), Nashville, Tennessee, Lodge No. 72
Box 124 (37221)
RAYMOND C. DOBSON (Secretary), Minot, North Dakota, Lodge No. 1089
Box 1150 (58701)

ROBERT E. BONEY (Assistant Secretary-Assistant Treasurer), Las Cruces
New Mexico, Lodge No. 1119 Drawer KK (88001)

ELKS NATIONAL FOUNDATION TRUSTEES

JOHN L. WALKER (Chairman), Roanoke, Virginia, Lodge No. 197
Box 720 (24004)
WILLIAM A. WALL (Vice-Chairman), West Palm Beach, Florida,
Lodge No. 1352, Box 986 (33402)
HORACE R. WISELY (Secretary), Salinas, California, Lodge No. 614
Box 2117 (93902)
E. GENE FOURNACE (Treasurer), (Newark, Ohio, Lodge No. 391)
Box 468, Canton, Ohio (44701)
ROBERT A. YOTHERS (Assistant Secretary), Seattle, Washington,
Lodge No. 92, Box 70307 (98107)
GLENN L. MILLER (Assistant Treasurer), Logansport, Indiana, Lodge
No. 66, Box 118 (46947)
WILLIS C. McDONALD (New Orleans, Louisiana, Lodge No. 30)
Box 89, Slidell, Louisiana (70459)

ELKS NATIONAL SERVICE COMMISSION

WILLIAM J. JERNICK (Chairman-Treasurer), Nutley, New Jersey,
Lodge No. 1290, 44 Alexander Avenue (07110)
GEORGE I. HALL (Vice-Chairman), (Lynbrook, New York, Lodge No. 1515)
8 Inner Circle, Scottsdale, Arizona (85258)
HOMER HUHNS, JR. (Secretary), (Mount Pleasant, Pennsylvania,
Lodge No. 868) 809 Shenandoah Drive, South;
Latrobe, Pennsylvania (15650)
RONALD J. DUNN, Oneida, New York, Lodge No. 767
112 Farrier Avenue (13421)
FRANK HISE, Corvallis, Oregon, Lodge No. 1413
Box 1047 (97330)
GERALD STROHM, Fresno, California, Lodge No. 439
Box 8127 (93747)
GEORGE B. KLEIN, Lincoln, Nebraska, Lodge No. 80
Box 83086 (68501)

ELKS NATIONAL CONVENTION COMMISSION

GEORGE I. HALL (Chairman Emeritus), (Lynbrook, New York, Lodge
No. 1515) 8 Inner Circle, Scottsdale, Arizona (85258)
ROBERT C. PRUITT (Chairman), (Atlanta-Buckhead, Georgia, Lodge No. 78)
3174 Peachtree Drive, N.E., Atlanta, Georgia (30305)
GLENN L. MILLER (Vice-Chairman), Logansport, Indiana, Lodge No. 66
Box 118 (46947)
ROBERT E. BONEY (Secretary), Las Cruces, New Mexico, Lodge No. 1119
Drawer KK (88001)
ROBERT A. YOTHERS, Seattle, Washington, Lodge No. 92
Box 70307 (98107)
LEONARD J. BRISTOL, Saranac Lake, New York, Lodge No. 1508
Box 1508 (12983)

ADVISORY COMMITTEE

RONALD J. DUNN (Chairman Emeritus), Oneida, New York, Lodge No. 767
112 Farrier Avenue (13421)
FRANCIS M. SMITH (Chairman), Sioux Falls, South Dakota, Lodge No. 262
Box 1700 (57101)
R. LEONARD BUSH (Vice-Chairman), (Inglewood, California, Lodge
No. 1492) Box 238, El Toro, California (92630)
GEORGE B. KLEIN (Secretary), Lincoln, Nebraska, Lodge No. 80
Box 83086 (68501)
WADE H. KEPNER, Wheeling, West Virginia, Lodge No. 28
1308 Chapline Street (26003)
GEORGE I. HALL (Lynbrook, New York, Lodge No. 1515)
8 Inner Circle, Scottsdale, Arizona (85258)
WILLIAM J. JERNICK, Nutley, New Jersey, Lodge No. 1290
44 Alexander Avenue (07110)
JOHN L. WALKER, Roanoke, Virginia, Lodge No. 197
Box 720 (24004)
HORACE R. WISELY, Salinas, California, Lodge No. 614
Box 2117 (93902)
WILLIAM A. WALL, West Palm Beach, Florida, Lodge No. 1352
Box 986 (33402)
ROBERT C. PRUITT (Atlanta-Buckhead, Georgia, Lodge No. 78)
3174 Peachtree Drive, N.E., Atlanta, Georgia (30305)
RAYMOND C. DOBSON, Minot, North Dakota, Lodge No. 1089
Box 1150 (58701)
ROBERT E. BONEY, Las Cruces, New Mexico, Lodge No. 1119
Drawer KK (88001)
EDWARD W. McCABE, Nashville, Tennessee, Lodge No. 72
Box 124 (37221)
FRANK HISE, Corvallis, Oregon, Lodge No. 1413
Box 1047 (97330)
GLENN L. MILLER, Logansport, Indiana, Lodge No. 66
Box 118 (46947)
E. GENE FOURNACE (Newark, Ohio, Lodge No. 391)
Box 468, Canton, Ohio (44701)
ROBERT A. YOTHERS, Seattle, Washington, Lodge No. 92
Box 70307 (98107)
GERALD STROHM, Fresno, California, Lodge No. 439
Box 8127 (93747)
WILLIS C. McDONALD (New Orleans, Louisiana, Lodge No. 30)
Box 89, Slidell, Louisiana (70459)
HOMER HUHNS, JR. (Mount Pleasant, Pennsylvania, Lodge No. 868)
809 Shenandoah Drive, South; Latrobe, Pennsylvania (15650)
LEONARD J. BRISTOL, Saranac Lake, New York, Lodge No. 1508
Box 1508 (12983)

GRAND LODGE AGENCIES

THE ELKS MAGAZINE, 425 West Diversey Parkway, Chicago, Illinois (60614)
JOHN R. RYAN, Publisher/General Manager
ELKS NATIONAL FOUNDATION, 2750 Lake View Avenue, Chicago, Illinois
(60614)
NELSON E. W. STUART, Executive Director
ELKS NATIONAL SERVICE COMMISSION, 370 Lexington Avenue - Room 1200
New York, NY (10017)
GEORGE M. HALL, Director
ELKS NATIONAL CONVENTION COMMISSION, 370 Lexington Avenue -
Room 1200, New York, NY (10017)
BRYAN J. McKEOGH, Director
PUBLIC RELATIONS DEPARTMENT (under the Grand Secretary's Office)
2750 Lake View Avenue, Chicago, Illinois (60614)
ELKS NATIONAL HOME, Bedford, Virginia (24523)
DORAL E. IRVIN, Executive Director



will you spend 15¢ to help us publish a better magazine?

The Editors of *The Elks Magazine* need the help of every reader. In an attempt to be responsive to changing reading habits and interests of the families who receive *The Elks Magazine*, we are asking you to fill out this simple questionnaire and return it to us within the next 30 days.

Your only investment will be five thoughtful minutes spent answering our questions; a **15¢** stamp, and an envelope addressed to:

**Research Department
The Elks Magazine
425 W. Diversey
Chicago, IL 60614**

IT IS NOT NECESSARY FOR YOU TO SIGN YOUR NAME.

Your participation will guide us in the future, and will result in your receiving a continuously improving magazine.

1. How often do you read *The Elks Magazine*?

- Every Issue
Often
Occasionally
Seldom

2. What other members of your household read *The Elks Magazine*?

- Wife
Other Male Adults
Other Female Adults
Male Minors
Female Minors
None

3. How would you rate, overall, the articles and columns that appear in *The Elks Magazine*, in regard to your own personal tastes and interests?

- Excellent
Good
Fair
Poor

4. Would you like to see more general interest features in the magazine and less Fraternal News?

- Yes
No

5. Would you like to see more coverage of Fraternal News in the magazine?

- Yes
No

6. Would you like to see the entire magazine devoted *only* to Fraternal News?

- Yes
No

7. What amount of articles on the following topics would you like to see?

	More	Less	Same amount
Business	_____	_____	_____
Health	_____	_____	_____
Sports	_____	_____	_____
Nature	_____	_____	_____
History	_____	_____	_____
Science	_____	_____	_____
Social Problems	_____	_____	_____
Recreation	_____	_____	_____
Self-help	_____	_____	_____
Animals	_____	_____	_____
Nostalgia	_____	_____	_____
Travel	_____	_____	_____
Medicine	_____	_____	_____
World Events	_____	_____	_____
(other) _____	_____	_____	_____

8. Which of these fraternal features are of most interest to you?

- News of the Lodges
 News of the State Associations
 Major Projects
 Joy of Giving
 Elks National Service Commission
 Special Awards and Tributes
 GER Visits
 GER Message

9. Which (if any) of the above fraternal features would you like to see omitted from the magazine?

10. How would you rate the monthly columns as to quality and your own personal interest?

	Excellent	Good	Fair	Poor
For Elks Who Travel	_____	_____	_____	_____
It's Your Business	_____	_____	_____	_____
You and Retirement	_____	_____	_____	_____
Medicine and You	_____	_____	_____	_____
Consumer News	_____	_____	_____	_____

11. What subjects would you like to have covered in monthly columns?

12. Which parts of *The Elks Magazine* do you like most? (least?)

	Most	Least
Fraternal Information	<input type="checkbox"/>	<input type="checkbox"/>
Fiction/Humor	<input type="checkbox"/>	<input type="checkbox"/>
Outdoor Articles	<input type="checkbox"/>	<input type="checkbox"/>
Travel	<input type="checkbox"/>	<input type="checkbox"/>
Advertising	<input type="checkbox"/>	<input type="checkbox"/>
Feature Articles (Business & General Interest)	<input type="checkbox"/>	<input type="checkbox"/>

COMMENTS & SUGGESTIONS

W

**Thank you very
much for your
cooperation**

NEWS OF THE LODGES

(Continued from page 26)



A THREE-minute shopping spree was held as a special project by the Elks' ladies of Miami, AZ, Lodge to raise funds for the ritualistic team's trip to the national convention. The proceeds for the event totalled \$1,039, and shopping spree champion Brother Marty Henderson donated his winnings to the Senior Citizens of Miami. PER Ira Welch Jr. (left) and ER William Adams (right) thanked Chairwoman Helen Rae Massey and Pres. Jan Weathers for their support.



THE ORANGE Meals on Wheels Fund, which provides meals for elderly shut-ins, received \$2,500 from Orange, CA, Lodge recently. Chm. Pierce Lyden (left) and ER Charles Bickel presented the donation to June Ableser, program coordinator. Orange Lodge is one of the founders of this charity program.



◀ **AN ANNIVERSARY** dinner-dance was held to celebrate Santa Monica, CA, Lodge's 75th year in Elkdom. On hand for the event were (from left) PGERs Horace Wisely and Gerald Strohm, ER Nicholas Kinzer, and PGER R. Leonard Bush. The dedication of the new lodge facilities preceded the festivities.

THE COLOR Guard of Pomona, CA, Lodge performed at an American Legion championship game recently. Sixteen Brothers serve on a rotating basis, and the army, navy, marines, and air force are all represented. Presenting the colors were Brothers (from left) Ross Bougher, former marine sergeant, Jim Miller, retired air force captain, Jack Wands, former air force sergeant, and Chm. John Porto, retired marine sergeant.



NEIGHBORHOOD Alert, a community support program in Hayward, CA, received a donation of \$500 from the local lodge recently. ER Weston Coolidge (left) presented the check to Neighborhood Alert Treas. Ben Dobus, Edith Lackey, editor of the program's bulletin, and Chm. James O'Meara. The contribution will augment the bulletin funds.



"The trouble with Boy Scouts is there aren't enough of them!"

WILL ROGERS

For ideas, or to make a donation to help make Will Rogers' wish come true—write:

The World Friendship Fund
Boy Scouts of America
North Brunswick, NJ 08902

DENTURE PAIN?

When emergency relief of denture irritation pain is needed, get on-the-spot relief with Ora-Jel/d. Ora-Jel/d contains an analgesic, anesthetic and antibacterial . . . so it works 3 ways . . . to relieve pain, help heal and prevent infection.

And if your dentures are new, Ora-Jel/d will help relieve denture discomfort during the break-in period.

Ora-Jel/d provides on-the-spot relief until you can see your dentist.

ora-jel/d

BINGO

FOR PERMANENT FUND RAISING

Easy way to raise money for your Organization because everyone has fun playing BINGO! Thousands of Organizations are making up to \$500.00 per week using "BINGO KING" supplies and FREE Idea Bulletins. Write for FREE catalog and details on raising money for your Organization.

PLEASE GIVE NAME OF ORGANIZATION.

'BINGO KING'

DEPT. EL-79, BOX 2499, LITTLETON, COLO. 80161

HEARING AIDS

SUPER SAVINGS! Newest. Finest. All types. Buy DIRECT & save up to HALF! No salesmen. Sold by AIR MAIL on HOME TRIAL FREE Catalog. Write: **MONEYSAVERS**, Dept. EK-11, 9530 Langdon Ave., Sepulveda, Cal. 91343

SAVE 1/2!

FREE CATALOG—WRITE!

BOOK AUTHORS!

Join our successful authors in a complete, reliable publishing program; publicity, advertising, handsome books. Send for FREE report on your manuscript and *Publish Your Book*.

CARLTON PRESS Dept. ELW
84 Fifth Ave., New York, 10011

FREE



You and Retirement

(Continued from page 20)

sure it's consistent; then continue walking at this rate for several days until it becomes a habit. Then increase the speed, just slightly, and become comfortable with the new speed. Gradually, over a period of weeks, lengthen your stride and exert a bit more energy. The idea, says Dreyfack, "is to achieve—but not to exceed—your maximum capacity. When you reach what you feel to be your limit, stop. This is your personal ideal walking pace."

Your natural pace is not the same as your ideal pace. You probably walk more slowly than you should for maximum exercise and benefit. If you step up your pace, and find the ideal pace for your height and the length of your legs, you will derive all the benefits of any well-designed exercise program. You will increase your pulse rate, tone your muscles, improve your cardiovascular capability, and so on—if you follow this pace walking program on a regular basis. Every day is ideal; three times a week is a bare minimum. Dreyfack cites one authority who claims that 15 minutes of walking every day is better than two hours' worth twice a week.

Walking is a sport that requires no expenditure and no special equipment, although proper footwear is a must. Walking, to give it one more boost, is a sport you can engage in any place and any time. If you're still working, a brisk lunchtime walk will perk you up for the rest of the day. If you're traveling, brisk walking while sightseeing can keep you feeling fit. And feeling fit, and being fit, is the foundation of good health. ■

Medicine and You

(Continued from page 28)

sodium—sometimes lots of it—in almost everything we eat, from the briniest pickles to the sweetest chocolate syrups and candy bars.

The Center for Science in the Public Interest, a consumer-interest group, has petitioned the U.S. Food and Drug Administration to require that all packaged-food labeling include the sodium content. This amount would be expressed as milligrams of sodium per serving of food. In addition, foods high in salt would be labeled "highly salted," and would have a picture of a saltshaker on the package to help elderly people with poor vision or people who cannot read. Nineteen U.S. senators and 52 representatives have endorsed the petition.

Apparently, any reduction in the excessive intake of salt by Americans will require a concentrated public education program and a reconditioning of taste buds. Campbell's Soups recently test marketed a no-salt-added line, but it didn't sell well and was withdrawn. We need to realize how pervasive an ingredient salt has become in the modern American diet, and that realization needs to be taken with far more than a grain of salt. ■

FUND RAISERS

Make Your Next Social A Profitable Success!



- THOROUGHBRED RACING
- HARNESS RACING
- GREYHOUND RACING

Whether it's Thoroughbred, Harness or Greyhound racing, A NITE AT THE RACES® offers the most unique "fun" and fund-raising program in popular use today.

A complete 16mm film package of actual races in vivid color with authentic track sounds and commentary also includes official programs, mutuel tickets, play money, computation forms and daily doubles. Exactas and quinellas available. **PAST PERFORMANCES and MIXED FORMAT RACING KITS** are also heavy favorites with A NITE AT THE RACES.®

Write today for free brochure or call us "COLLECT" now!

a nite at the races, inc.

2320 Ave. "U" • Brooklyn, N.Y. 11229
Tel: 0-(212) 769-7355

ONE MAN SAWMILL

NOW! BEAT Inflation and HIGH Lumberyard Prices!
No need to stop your important projects.

Take this portable mill right to the trees—turn out smooth, true lumber every time—no experience needed. Saw your own logs or lumber for others and make excellent spare-time income—no crew needed. Use any power—tractor PTO, diesel, electric. Time payments may be arranged. Send for FREE details—mail coupon below or postcard TODAY! No Obligation and No Salesman Will Call.

World Famous Since 1928
BELSAW MACHINERY Co., 3063 Field Bldg. Kansas City, Mo. 64111 CASH COUPON TODAY!

Name _____ (Please Print)

Address _____

City/State _____ Zip _____

AT LAST! YOU CAN BE AN AUTHORITY ON HISTORY

Send \$1.00 (refundable on first purchase) for catalog of historically accurate:

- Miniature Soldiers & Cannons in Pewter
- Uniform Prints & Post Cards

Mail today to:

Professional Information
Box 566, Dept. E
Spring Lake, N.J. 07762

BOOK OF MEMORY

in everlasting bronze

For listing 100 to 3250 names of deceased members economically. Write for free catalog showing photos of hand-chased cast bronze plaques.

NEWMAN BROTHERS, Inc.
5625 Center Hill Avenue
Cincinnati, Ohio 45216

The Cadre Noir

(Continued from page 30)

prove that after a severe test of endurance the horse has the energy to continue in service.

The former member of the Cadre Noir who brought the United States Equestrian Team to world dominance is Jack LeGoff. In the 1960 Rome Olympic Games, LeGoff rode on the French Bronze Medal eventing team. One of his teammates was Pierre Durand. Both men have risen to eminent positions in the equestrian world. LeGoff is now coach of the United States Combined Training Team, gold medal winners of the Montreal Olympics. Lt. Col. Pierre Durand is the current *Ecuyer En Chef* of the Cadre Noir.

Jack LeGoff has often been called the Vince Lombardi of riding. He is a strict disciplinarian who believes in the basic fundamentals and the pursuit of excellence. His equestrian team won the 1976 Olympic Gold Medal, the 1974 World Championship, the 1975 Ledvard International Horse Trials, and the 1975 Pan American Games. LeGoff coached Bruce Davidson, who won the individual World Championship in 1974 and 1978.

The Cadre Noir offers two presenta-

tions to the public. I was not prepared for the sheer beauty of their display. The color of the uniforms, trappings and saddles, combined with superb riding to the accompaniment of military music, sent shivers up my spine. First came the *Ecuyers* performance. Known as the "Black Mass," it recalls the military teaching in Saumur and the distant influence of the Versailles school. This horsemanship event is led by the *Ecuyer En Chef* who, by tradition, is the only one to show the school walk and the sustained trot. The production includes the riders taking their horses through simple figures, the two-track, flying changes and *Passage*, but does not include the more difficult moves of more advanced equitation. It is a show of true equestrian choreography whose vibrant and rhythmic poetry moves even the untutored spectator.

The riders use the old "Royal Saddle" adapted from the saddles of the Middle Ages, made from white buckskin, with a gold and purple saddle cloth. The *Ecuyer En Chef* has the privilege of using a purple velvet saddle, and the reins of his bridle are woven in gold thread.

After this elegant display comes the dashing performance of the *sauteurs* (jumpers). The riders enter with their mounts at full gallop, showing their

masterful horsemanship by keeping their spirited horses under complete control at all times—a typical example of the French *joie de vivre*. Their studied saddles are without stirrups, called "*Jelle à pique*." Two cushions are placed in the front and back of the seat, designed so the cavalier could use his lance in tournaments. They draw spontaneous applause when they perform the "Airs Above the Ground," and the *Courbette*, where the horse raises his forelegs while supporting himself on his hind legs. The *Croupade* is an above-the-ground movement in which the horse executes a kick by completely stretching out his hind legs while the fore limbs remain on the ground supporting him.

During this exciting performance, the senior *ecuyer* stands in the middle of the circle giving the commands for the *Croupade* and *Courbette*. Twelve riders must carry out these movements together, a most difficult feat. The awe-inspiring and delicate *Capriole* is done independently. In this movement, the horse leaps simultaneously with all four feet off the ground and, at the height of his leap, kicks out violently with his hind legs. One doesn't need to know anything about horses to enjoy the entire riding exhibit of the Cadre Noir. ■

LODGE VISITS

GRAND EXALTED RULER

Robert Grafton



GER Robert Grafton's visit to North Dakota included meeting with Governor Arthur Link at the state capitol in Bismarck. PGER Raymond Dobson, state sponsor, introduced Brother Grafton to the governor. An autographed copy of the *Elks Magazine*, in which a photograph of Governor Link participating in the North Dakota Elks Youth-Adults Camp Program was published, was presented to the governor by the GER.

Brother Richard Blair and PER Franklin Roberts, both of Bismarck Lodge, greeted the visitors, including Mrs. Gene Dobson and Mrs. Pat Grafton. While in North Dakota, GER Grafton delivered a speech at a state meeting held in Dickinson. He also attended a pageant at Medora, where Theodore Roosevelt once ranched.



PGER Raymond Dobson (above, left) introduced GER Robert Grafton (above, right) to Governor Arthur Link (above, center). The governor (below, center) welcomed (from left) Brother Richard Blair, PGER Raymond and Gene Dobson, Pat and GER Robert Grafton, and PER Franklin Roberts to the capitol in Bismarck, North Dakota.



Escape To Fantasy Land

by Jerry Hulse



Frighening the wits out of vacationing Americans is the newest rage across the U.S. Theme parks from California to the Carolinas are competing for the distinction of operating the world's scariest rides. To name a few: Greezed Lightnin', Montezuma's Revenge, the Screamin' Demon, the Barnstormer and Shock Wave.

At Marriott's Great America in Santa Clara, CA, the white knuckler is a heart-stopper titled the Tidal Wave. This has nothing whatsoever to do with oceans. Rather, it's a wild and woolly roller coaster ride that carries the customer upside down through a breathtaking loop, followed by a dip down a dizzying incline. And are you ready for this—just about the time everyone relaxes, it races backward (yes, backward!) over the very same course at speeds reaching 55 miles an hour.

There are a couple of others—the Turn of the Century and Willard's Whizzer. The former is described by Marriott as "the wildest, scariest, most exciting corkscrew roller coaster in the world." By comparison, Willard's Whizzer is for sissies. No loop-the-loops, just a 55-m.p.h. spin with 70-degree banking turns. By now, if one is still game, Marriott also provides rides on a two-story merry-go-round, as well as a three-wheel ferris wheel.

Marriott's Great America is spread across a 200-acre parcel of real estate 45 miles south of San Francisco. Visitors feeling weak-kneed after the roller coaster rides can book a room in the Santa Clara Marriott that is adjacent to the \$50-million park. The park itself is divided into five sections: Hometown Square, the Great Midwest Livestock Exhibition and County Fair, Yukon Territory, Yankee Harbor and Orkney Place. Besides chilling loop-the-loops, the park operates a theater featuring the life story of Bugs Bunny, plus a review of Hollywood musicals over a 40-year span.

This penchant on the part of Americans to escape into theme parks goes on across the nation. Outside Chicago in Gurnee, IL, Marriott operates a second park with an identical white-knuckle ride. It, too, is known as the Tidal Wave. And at Knott's Berry Farm in Buena Park, CA, there's an upside-down roller coaster ride that's guaranteed to cause a gasp. Or better yet, a scream. Magic Mountain in the San Fernando Valley calls its coaster the Colossus, a demon that accomplishes everything but cracking the sound barrier—that and the rider's sacroiliac. Cars climb 126 feet into the wild blue, then race toward the ground at 60 m.p.h. It takes four minutes. But some customers claim it's more like four hours.

A second Magic Mountain in Buskill, PA, provides similar thrills. Here, the

Escape To Fantasy Land

coaster known as the Screamin' Demon, carries riders 65 feet into the air, then sends them hurtling back to earth at 60 m.p.h. That coaster riding has gained national prominence is attested to by the fact that several months ago at Busch Gardens in Williamsburg, VA, fans held a convention. The reason for choosing Williamsburg was because Busch operates one of the tallest, fastest coasters in the world there. Known as the Loch Ness Monster, it reaches speeds of up to 70 m.p.h. and covers 3,240 feet in barely two minutes.

Americans travel millions of miles each year to vacation at the new U.S. theme parks. And coaster riding is one of the big attractions. At Astroworld in Houston, they climb aboard one named Greezed Lightnin', learning what it's like to be nearly weightless. Greezed Lightnin' carries them from 0 to 60 m.p.h. in four seconds. Like Marriott's Tidal Wave, Greezed Lightnin' sends its riders hurtling backward following the neck-cracking start.

In Jackson, NJ, a \$2.3-million ride called Lightnin' Loops features a couple of coasters with interlocking vertical loops. It's another forward-backward test of the sacroiliac, not to mention the nerves. At Circus World, a theme park in Haines City, FL, they've installed a new ride (the Florida Hurricane) that bobs and weaves among trees and valleys for 3,500 feet. For those who panic at the idea of roller coasters, "airplanes" provide the thrills at Opryland in Nashville, TN. One simply climbs into the cockpit of an old-time biplane to be dropped from a 108-foot tower into a lake.

This has nothing to do with rides,

but the scare feature at Planet Ocean in Miami is a hurricane. Indeed, it's the world's first indoor hurricane. High winds, lightning, thunder, rain—the whole bit. But back to coasters: at Six Flags Over Georgia, the world's only triple loop ride—a \$2.1-million contraption called the Mind Bender—carries passengers through three loops at nearly 50 m.p.h. Operators claim that passengers experience gravity of nearly six times normal during the two-minute, 33-second ride. And then at Six Flags Over Texas (Dallas-Ft. Worth), it's the Shock Wave. This 60 m.p.h. roller-coaster thrill is billed as the world's fastest, tallest double loop. First it's up, up, up till the coaster has reached an elevation of 116 feet. Then passengers are scrambled with two vertical loops, followed by an upside-down ride. (Pass the Dramamine, please.)

At Worlds of Fun in Kansas City, once again it's something besides coasters. Here the passengers strap themselves into airplanes 10 stories above the park. Someone pushes a button and round and round they go till, at last, they plunge 60 feet toward earth, stopping just in the nick of time.

This business of theme parks got started back in the '60s with the opening of Disneyland in Anaheim. Since then, millions of Americans have spent at least some of their vacation time escaping the real world. The biggest money-maker of them all is Disney World in Orlando, FL. While everyone's trying to build a better mousetrap, no one did it better than the Disney organization. Monorails roar through the lobby and restaurant of one hotel, deer roam through Fort Wilderness and alligators crawl among the swamps. At Disney World, one may camp, play golf or sun on man-made beaches. Hacked from a former wilderness, Disney World covers an area nearly the size of San Francisco. Not only an amusement park, it is a com-

plete vacationland. The Disney operations, both in Anaheim and Orlando, were the forerunners of dozens of other parks that exist today. Bengal tigers roam through Busch Gardens in Tampa; dolphins play at Sea World and Marineland in California and lions pad through the veldt at Lion Country Safari in San Diego.

But if theme parks and scare rides don't turn you on, there's another ride that will—a trip aboard Tad Finlay's Fun Time Express (a train, not a roller coaster) that operates across the U.S., Canada and down into Mexico.

It was during the '50s, while working as a traffic engineer with the City of Los Angeles, that he turned a boyhood hobby into an adult dream. Assisting the All-City Employees Assn., he chartered a train for a weekend blowout in Las Vegas. It was a smash hit. With the glow of success, Finlay put together a second rail tour, this time to Sun Valley. (By now, he was really steaming.) Finlay's gang whooped it up the entire way, plunking down \$165 each for the train ride, hotel, meals, skiing and skating. Even in those days it was a steal and, although the price was right, the city still made money. Encouraged, Finlay worked out a third excursion, chartering several cars on the Southern Pacific to Salt Lake City ski resorts. Only this time he snagged an empty baggage car, and the passengers danced their way to the Utah capital. Sleeping on the train, they got the entire weekend package (Friday through Sunday) for \$65.

Later, after running a rail tour to Mexico, Finlay quit his job with the city and hitched his caboose to a star. It's grown brighter each year. By now, he's the *biggest* independent railroad operator in the nation, the owner of cars worth a sizable fortune.

Finlay refers to his excursions as Fun-Time Tours. And they are. Passengers line up for bingo and bridge, while practicing the 5 o'clock cocktail ritual in a bar car that seems never to run dry. Pardon me, boy, but this is the charismatic choochoo. "Operated with the graciousness of a cruise ship," says Finlay.

Even so, Finlay gambled when he decided to ride the rails for a living. Everyone, it seemed, had forsaken trains for flight. But Finlay believed. He sensed that there was an audience waiting in the vestibules for old-time harmony and an elusive peacefulness that's impossible to find at 35,000 feet in the heavens. He was right, of course. With life in the cities growing more hectic, thousands of travelers were weary of the crunch. That's when Finlay went to work selling nostalgia by the trainload.

Mexico is the destination of his most

Fine Elks Jewelry



NEW! EXTRA LONG TIE BAR—For the wider ties. A handsome 3" long polished Hamilton gold tie bar with blue, red and gold emblem and strong spring clip. Each.....\$3.80



NEW! JEWELERS BRONZE BELT BUCKLE—features 1 3/16" emblem and raised panel on a satin textured background with polished border. Large 2 1/4" x 1 3/4" size accommodates belts up to 1 1/2" wide. Each.....\$5.10

We stock a complete line of Elks personal jewelry and accessories. Write for free catalog.

Prices include postage.



RUSSELL-HAMPTON CO.
Dept. E, 2550 Wisconsin Avenue
Downers Grove, Illinois 60515
(A Chicago Suburb)

To serve you better, we have moved to larger, more modern quarters.

popular tour: the Copper Canyon, Guadalajara, Lake Patzcuaro, Morelia, Mexico City, Cuernavaca, Taxco, Fortin, Veracruz, Campeche, Oaxaca, Merida, Chichen Itza, Uxmal, Kabah and Palenque. There are others, but that will give you an idea. Mexican guides and air-conditioned buses are provided for sightseeing.

Finlay's next most popular tour is a combination rail-river excursion into the South. In New Orleans, passengers board the Mississippi Queen for a cruise upriver to Natchez. Others join the Delta Queen in Cincinnati.

Finlay's "America's Heartland" tour gets other raves. In Durango, CO, passengers board the famed Rio Grande narrow-gauge railroad for the trip to the alpine town of Silverton. Other stops on the Heartland tour include Albuquerque, Santa Fe, Chicago, Cincinnati, St. Louis, Eureka Springs (AR), Jefferson City and Dodge City, with an intermission aboard the beloved old Delta Queen for a cruise down the Ohio and Mississippi rivers.

This is the stuff of which memories are made, says 58-year-old Tad Finlay, the jolly, unpretentious entrepreneur who still adores trains, even after spending more than 20 years plowing back and forth across the United States and Mexico. Other Finlay tours cross the continent to Eastern Canada, taking in Niagara Falls, Quebec and the Gaspé Peninsula. From Nova Scotia, there's a cruise to New England, followed by an excursion to New York, Williamsburg, Jamestown, Concord, Lexington and Washington.

In recent years Finlay has spread his wings, sending travelers to the Caribbean and on rail/ship tours of Europe. It is his Fun-Time Tours of the United States and Mexico, though, that bring him his greatest fame. (You can swing aboard by contacting your travel agent or Finlay Fun-Time Tours, 11306 Burbank Blvd., North Hollywood, CA 91601.) His cars, Finlay insists, are in better shape than anything Amtrak has. One that's paneled in solid cherry with Tiffany lamps and leaded windows (two bedrooms, a dining room, kitchen, lounge, library and bath with both tub and shower) was an anniversary gift for his wife. Finlay bought the car from the Erie Lackawanna Railroad. Several months ago, it carried Mickey Mouse and the Disney entourage back to Washington for Mickey's 50th birthday anniversary. Another time, it was chartered by the late Howard Hughes for a trip to Boston. Finlay admits his railroad lacks one important item: an engine. But shucks, it's no cause for worry. Finlay merely hooks onto Amtrak (or else some train in Mexico) and leaves the pulling to someone else.

Lodge Bulletin Contest

The GL Lodge Activities Committee is announcing the details of this year's Lodge Bulletin Contest. It is the desire of this committee that each lodge send an entry for this year's contest.

The lodge bulletin should advise the membership of the activities of the lodge and therefore should include pictures (please do not send pictures of members drinking), express thoughts concerning the lodge and its conduct, and be a forum to stimulate the membership to participate in your program. The judges will consider the timeliness of the articles, the quality and number of committee reports, the presentation of Grand Lodge, state association, and auxiliary projects, reviews of special events, and coverage of items of special interest to the lodge. If your bulletin contains ads, they should be the size of a business card and should not include "Brother Elk" or "I'm a member."

It is recommended that your entry consist of three consecutive issues between the period April 1, 1979, and December 31, 1979, bound neatly and sent to this committee. Your lodge secretary must certify in writing the total membership as of April 1, 1979. Entries must be postmarked no later than February 1, 1980, to be eligible for judging. They will not be returned, but winners will be on display at the GL Lodge Activities Committee booth during the Grand Lodge Session in New Orleans, July, 1980. A lodge representative should pick up the winning entry.

Awards will be presented to first-, second-, and third-place winners in the five divisions of membership listed: Division 1—Lodges with under 301 members; Division 2—Lodges with 301 through 600 members; Division 3—Lodges with 601 through 1,000 members; Division 4—Lodges with 1,001 through 2,000 members; Division 5—Lodges with 2,001 or more members.

Mail entries to Richard J. Stropes, Member, GL Lodge Activities Committee, 2117 Sunset Dr., Pekin, IL 61554. Do not mail entries to the *Elks Magazine*.

Support Grand Exalted Ruler Robert Grafton and his great program by participating in the Lodge Bulletin Contest. Remember, your lodge can help "Build a Better Elksdom."

Richard J. Stropes, Member
GL Lodge Activities Committee

When the Deal Collapses . . . When Your Nerves Are Tight as a Drum . . . Relax!

RUN YOUR OWN RAILROAD!

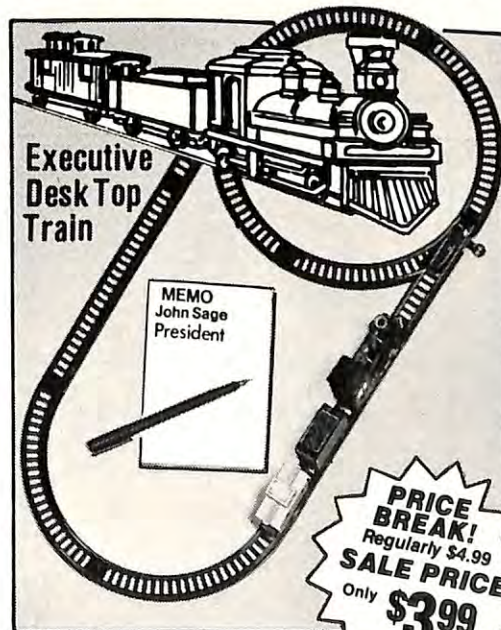

Let it roar past your "In Basket." Switch the tracks and it will take the express route past your phone. If your desk is cramped, it will even set up in an 11" circle, perfect for your desk drawer.

Our tension-breaking "Executive Electric" packs a lot of pleasant relaxing into a tiny bit of space. But though it's super-compact, it is a complete model train in every way.

You get a 3 1/2" authentically-detailed steam locomotive with tender and bright orange caboose; 6 ft. of 3/4" tracks and two switches. No need for bulky transformers or tangles of wires—this railroad runs for many fun-filled hours on a single penlite battery. Arrange track layout to fit your free desk space—either 2 ft. x 10 1/2" oblong or an 11" circle. The tracks snap together instantly for easy set-up and disassemble just as fast for convenient storage.

Yes, for less than the price of a single round-trip commuter ticket, you can run your own railroad! Order several sets—for yourself, for the kids (you surely won't want to part with your set!). Satisfaction completely guaranteed. Only \$3.99.

PRICE BREAK!
Regularly \$4.99
SALE PRICE
Only **\$3.99**

STATE SALES TAX CHART. Please add to your remittance OK 2%, AR CO GA IA KS LA ND VT 3%, MO 3 1/8%, NE 3 1/2%, AL AZ FL IL IN MI MN NC NM SC VA WI 4%, OH 4 1/4%, KY MA MD ME MS NJ SD TX UT 5%, WA 5.2%, CA PA RI TN 6%, CT NY 7%, NYC 8%.

spencer GIFTS D-48 Spencer Bldg.,
Atlantic City, New Jersey 08411
Bringing You Direct Mail Savings For Over 30 years

15-DAY NO-RISK TRIAL OFFER

Spencer Gifts, D-48 Spencer Bldg., Atlantic City, N.J. 08411

Please send me "Executive Electric" Train(s) #86215 @ \$3.99 each plus 75¢ postage and handling.

SAVE \$1.00! Order TWO sets for only \$6.99 plus \$1.50 postage and handling.

I understand that if I am not completely satisfied, I may return within 15 days for a complete refund of the purchase price.

Cost of Train set(s) Ordered \$ _____
Add Postage and Handling \$ _____
Add Sales Tax (see chart) \$ _____
I enclose # check or money order
for Total \$ _____

Print Name _____

Address _____

City _____

State _____ Zip _____

© Spencer Gifts, Inc., 1979

Carry TEN TIMES a Wheelbarrow Load with INCREDIBLE EASE!

These BIG, strong carts are perfectly balanced on two huge wheels — roll easily over lawns and gardens — carry up to 400 lbs. of load — huge volume capacity means you make fewer trips — you'll save time and steps. If you are still struggling with a wheelbarrow or inadequate cart (with tiny wheels) send for FREE Cart Catalog. Build-it-yourself kits, too.

GARDEN WAY RESEARCH
Charlotte,
Vermont
05445



© 1979 Garden Way, Inc.

GARDEN WAY RESEARCH

Dept. 9012N

Charlotte, Vermont 05445

Please send FREE CART CATALOG.

Name

Address

City

State Zip



Personalized Photo Jigsaw Puzzle

Turn a special picture into a one-of-a-kind gift: a deluxe 8" x 10" jigsaw puzzle. Full-color or B/W, depending on the photo you send. It makes a perfect holiday greeting, a special thank you, or simply a unique token of affection. Mail print or negative (returned unharmed) and \$4.50 postage paid. For rush orders, send an additional \$2.00 and we'll ship your puzzle the same day it's received.

American Studios

Dept. E11-79, La Crosse, Wisc. 54601

Elks Family SHOPPER

Useful and unique
new products for
indoors and outdoors

LOG ROLLER

with
wheels

SAVES
Your back,
clothing
and ...
saves steps.

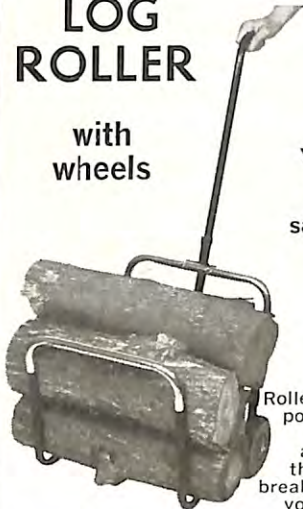

Let this Log Roller be your log porter. No more tired, aching arms... ends that dirty back-breaking job. Now you can enjoy a roaring fire with one easy trip to the log pile—Just place logs onto your Log Roller with Wheels and away you go. With its big wheels and special design you can even go up and down stairs with ease. Sturdy tubular steel construction to hold 50 pounds of firewood from your patio, garage or basement. This Log Roller with its attractive brass and black finish is handsome enough to park near your fireplace! Only \$14.97 plus \$2.40 shpg.

Send Check or M.O. 20 day money back guarantee.
Dept. EK-119, 1118 W. Lake,
Box 370, Tawas City, MI 48763

HOLST, Inc.

Super Gift For Super People



Remarkably attractive and sure to leave a lasting impression. Twisty Fix-O-Loc Key Keyper with the Elks Medallion—or your favorite sport. Available in 18 kt gold or silver finish. Made of flexible stainless steel aircraft cable with the patented Fix-O-Loc closure. Life time guarantee. Gift box.

Price \$4.98 plus 50¢ postage and handling.

Send check or M.O.

DIXIE PRODUCTS

P.O. Box 1370, Hurricane, Utah 84737

AT LAST — BIRD FEEDERS THAT FOIL SQUIRRELS!!

Revolutionary new design with flexible perches that support birds NOT squirrels. Large capacities multiple feeding stations, built-in water/suet holder, free filling funnel make these the finest feeders available.

#460 Wild Bird Feeder (shown)
Holds 1½ lbs. seed. \$7.98

#465 Finch Feeder Holds 2 lbs. thistle feed.
Ideal for all thistle feeding birds. \$6.98

Mastercharge and
Visa welcome

Both Feeders
Only \$13.50

Springtime DEPT. E11

31 ALDEN RD., WAYLAND, MA 01778 • (617) 358-5106 EX. 100



GIVE YOUR CAT A BRAND NEW OUTLOOK ON LIFE!...with Kitty Purr-Ch, a shag-carpeted window platform. Let your cat look out a window or doze quietly in the sun. Fits on any window... installs without tools in most cases. Won't mar walls. Shag covers come in gold, forest green or royal blue. Removable for easy washing. \$14.95 + \$1.50 shpg. Kitty Purr-Ch, 5958 North 83rd Street, Dept. 82, Scottsdale, AZ 85253

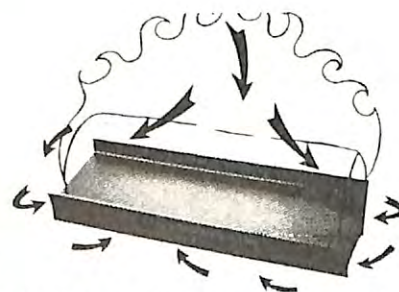

NOW A NEW PRODUCT MAKES YOUR FIRELOGS burn longer. X-TEND-A-FIRE trays hold synthetic wax-base logs together, letting melting wax self-feed for brighter, more colorful flames. Rear deflector changes draft pattern so logs burn up to 2 hrs longer. Heavy gauge steel X-TEND-A-FIRE tray reduces residue, smoke and odor. Guaranteed or money-back. \$12.00 ppd. Mid-Co Fires, 119 Daisy Circle, Midlothian, Texas 76065



SOLID COLOR NECKTIES

3 for \$11.00 ppd

Finest Polyester
Quality Construction
New 3" Width

Washable (No Pressing Required) Choice of Navy, Brown, Green, Wine, White or Black. Attractive gift box - FREE

money back guarantee

ALLAN NECKWEAR

P.O. Box 344H, Hampton, N.H. 03842



MICHELOB TELEPHONE—THE TALK OF THE TOWN! The graceful and distinctive lines in the beer industry now creatively designed into lines of communication. 17 inches high, the Michelob Telephone is fully functional, easily connected, and FCC approved. For your home, office or bar. A perfect Christmas gift. \$139.95 + \$2.50 shpg. Free color brochure & order blank available. Procreative Marketing, Inc. P.O. Box 16883, Tampa, Florida 33687.



PROTECT YOUR FOOD DOLLARS! Our Freezer Vacuum Pump removes air from plastic bags to protect your food with a few easy pushes. No more spoilage from freezer burn or loss of flavor, color or nutritional value. Extends shelf life of bread, cheese, leftovers. Protects household articles from the hazards of air. \$2.95 + 75c shpg. Easy instructions incl. The Wooden Spoon, Dept. 336, Rt. 6, Mahopac, NY 10541



DAZZLING FAKE DIAMONDS—For dramatic sparkle at an affordable price, take a look at Magic Fire Gems. The rings, earrings and pendants have much of the brilliance and intrigue of real diamonds. A lot of luxury for your money. Free brochure. The Crown Collection, ELN, 509 Madison Avenue, New York, NY 10022

Wrinkles Away Hand Steamer



The quick "touch-up" for travel and home! New 3 minute way to steam away wrinkles. Ideal for: suits, blouses, skirts... even hanging draperies! Light and portable; works on all fabrics. A great Christmas gift idea, too! \$19.95 (2 for \$35.90) + \$2 shpg. Master Charge, VISA.

INOVAR INTERNATIONAL

2176 Palou Ave., Dept. E1
San Francisco, Ca. 94124

CALL TOLL FREE 24 hrs.,
Credit Card orders (800) 648-5311
(in Nev. (800) 992-5710)



With Built-in RADIO

Your Own "Last of a Breed" Personal Collector's Item

Cadillac CONVERTIBLE

A superb replica of the elegant 1963 Cadillac CONVERTIBLE with built-in SOLID STATE RADIO (battery included). The magnificent body (10" x 3 1/2" x 2 1/2") with its sleek long lines and silver-chrome colored finish is reproduced to perfection, including rubber tires. CONVERTIBLE production has stopped. Now is your chance to own this collection piece. If not delighted, return for refund within two weeks.

\$19⁹⁵

A great gift for home or office

HOUSE OF ORLEANS, CD-83, 2042 Armacost Ave., W. Los Angeles, Ca. 90025

Ship _____ Caddy(s) at \$19.95 ea. plus \$2.00 shipping (Ca. residents add tax)

Enclosed is \$ _____ (check or m.o.) or charge my acct. Carte Blanche Diners

American Express Master Charge BankAmericard Card expires _____

Acct. No. _____ Signature _____

Name _____ Address _____

Apt. _____ City _____ State _____ Zip _____

FREE HOT AIR

Don't lose it! Use it.

ThermoCycler™

PATENTED

Why haven't they thought of it before?
A simple device that warms cold floors, lowers heating costs... and conserves energy.

Here's how the ThermoCycler® works:

As everyone knows, warm air rises. With most heating systems, temperatures at ceiling and floor vary as much as 30 degrees. The ThermoCycler simply draws down ceiling heat and gently disperses it at floor level. It mixes with cooler air and initiates thermal circulation.

This continual recycling of air greatly reduces heat loss at ceiling level, keeps floors warm and increases general comfort—at lowered thermostat settings.

- Priced economically ■ Assembles in seconds ■ Virtually soundless
- Safe, unobtrusive, guaranteed ■ Uses less than 10 watts of electricity (day and night operation for 12¢ to 35¢ a month) ■ Used by more than 120 Federal Housing Authorities

SEND FOR YOUR FREE BROCHURE. WRITE OR CALL:
(503) 638-8602

MBS (Manufacturers Business Services)
P.O. Box 8 - 11975 S.W. Herman Rd. - Tualatin, OR 97062

© MBS 1979

**POPULAR BLAZER IN
SOFT PIGSKIN LEATHER**
SALE PRICE **\$99** REG \$125
ONLY



What a great fashion investment this blazer will be for your wardrobe! Soft and supple, its classic styling and pigskin's natural ageless beauty make it a remarkable buy at only \$99.

The "Eaton" is meticulously tailored to add new dimensions to your blazer way of life. Updated styling with narrow notched lapels and traditional patch pockets. The back is smartly set off by curved seam detailing and center vent. Fully rayon lined, with 3 inner pockets. This durable, comfortable blazer will take you from office...to after-hour engagements...to weekend outings. You'll be gathering compliments for many seasons to come. A truly exceptional value. Specify Golden Tan or Golden Brown.

Available in even sizes only, 36 to 46. Only \$99
Long sizes 40, 42, 44, 46. Only \$109

BERMANS THE LEATHER EXPERTS

**MONEY BACK GUARANTEE!
MAIL NO-RISK COUPON TODAY**

BERMANS LEATHER DIRECTIONS
113 27th Ave. N.E., Minneapolis, MN 55418
USE YOUR MAJOR CREDIT CARD
PHONE 1-800-328-2411

(In Minnesota, Call Collect 612-789-4381)

Please send me the following "Eaton" Sueded Pigskin Blazer(s):

Regular Sizes (36 to 46) \$99:

Golden Tan (1-8021-AB) Golden Brown (1-8022-AB) SIZE

Long Sizes (40, 42, 44, 46) \$109:

Golden Tan (1-8023-AB) Golden Brown (1-8024-AB) SIZE

Add \$3.00 postage and handling per blazer.

Check Money Order enclosed for complete total of \$_____.

I understand that if I am not fully satisfied, I may return blazer(s) for a complete refund of the purchase price.

Charge to: CB MC VISA AE DC

Card # _____ Exp. Date _____

Name _____

Address _____

City _____ State _____ Zip _____

Prices effective through March 31, 1980



A beautiful way to survive the winter. Power failures, oil shortages—it'll be a tough winter to keep your family warm. Better 'n Ben's Fireplace Insert is the answer. It'll heat 4 to 6 rooms and actually add to the beauty of your fireplace. Wood heat is the practical, safe, alternative energy. And Better 'n Ben's is the leader in fireplace woodstoves. Our 24-page booklet tells you about all our stoves, plus facts you should know before you buy any woodstove. Send \$1.00 for postage and handling to: Hayes Equipment Corp., P.O. Box 526-E, Unionville, CT 06085. 203-673-2556. Dealer inquiries invited.

**MAKING
SENSE
OUT OF
WOOD
STOVES**

Better'n Ben's®
Our stoves make more sense.



America's
BEST
Values!

greenhouses

Shatterproof fiberglass/California Redwood. Designed for the home gardener. Freestanding, lean-to and dome models, accessories. Use my "guaranteed price" lay-away plan.

Write today for my FREE fact-filled, helpful color catalog.

Peter Reimuller —The Greenhouseman®
98017th Ave., Dept. 12-L, Santa Cruz, Ca 95062

Elks Family Shopper

consumer/news

Trying to plan an autumn vacation close to home? How about exploring the **National Parks** in your area? Here's a deal that can help you save on money while you're saving on gas. A Golden Eagle passport can be yours for only \$10, and it's good for the rest of 1979. And if someone you know is over 62, he or she will want to get a free "Golden Age" Passport.

A free booklet from the Department of Interior tells you about these special permits. You can get your copy of *Golden Eagle and Golden Age Passports* by sending a postcard to the Consumer Information Center, Dept. 631G, Pueblo, Colorado 81009.

The Golden Eagle Passport admits you and a carload of passengers to National Parks and recreation areas throughout the United States, during 1979. And you can enter these parks as many times as you wish.

If you're 62 or older, a Golden Age Passport will give you a free lifetime entrance permit to the national parks, monuments, and recreation areas where fees are

(Continued on page 54)

Anyone for Tenons?



If your racket is tenons, doubles or singles, and you want a perfect match every time, you can learn from the professionals. They know a classic way to join two pieces of wood together is with a tenon that fits into a mortise.

Fine Woodworking magazine speaks this language to more than 100,000 readers—people seriously interested in making beautiful things out of wood. Whether you are an aspiring novice or an accomplished expert, you'll find it an especially informative magazine, with finely detailed articles about techniques and tools, materials and design. It's written by master craftsmen who share their many years of wood-working experience. And it's printed on heavy paper to withstand years of reference. All back issues are in print and indexed periodically.

If you want to become a better woodworker, write for more information about this beautifully illustrated bimonthly magazine. Better yet, send \$12.00 for a one-year subscription (Visa or Master Charge accepted). If you're not pleased, we'll be happy to refund.

EASY PERMANENT INSTALLATION

DRUG SAFE

- IN BATH CABINET/LINEN CLOSET
- KEEPS DRUGS CHILD-RESISTANT
- LOCKS BY COMBINATION • STURDY PLASTIC 4 1/2x6 1/2x3 3/8 D. • ORDER SEVERAL

ENCLOSED IS \$ _____ FOR
DRUG SAFE(S) AT \$8.50 EA. POSTPAID.
MICH. RESIDENTS ADD 4% SALES TAX

NAME _____
ADDRESS _____ APT. _____
CITY _____ STATE _____ ZIP _____

SAF-T KIT, INC.
PO BOX K, ST. JOSEPH, MICH. 49085

Fine
Woodworking®

The Taunton Press
52 Church Hill Rd.
PO Box 355-XM
Newtown
Connecticut 06470

Own the World's most perfect watch...

The only "PURE-SOLAR" timepiece in existence. Guaranteed to outperform any watch sold today...or costs you nothing!



The Sunwatch... never needs batteries... accurate to within 1 second per month... virtually indestructible, beautifully styled sport/dress watch.

An engineering/design breakthrough in space-age timekeeping technology... that now makes all other watches obsolete: ■ 100% sun-powered, no batteries that need replacing. ■ Clearly visible by day or night. ■ Unique side-window view, simplifies reading. ■ Built-in computer calendar — no need to ever re-set the watch (Not even in 31-day months and leap years!) ■ Unprecedented accuracy — you program the Sunwatch's computer to stay accurate within 1-second per month!

A "State-Of-The-Art" timepiece that combines solar energy efficiency with a unique feeling of futuristic elegance and beauty. 10 years ago the Sunwatch was an idea, years ahead of its time, on the drawing board of Roger Riehl, a noted expert in solar energy, integrated circuitry, and computer chip technology. As a result of these years of costly and extensive research, Mr. Riehl's dream of a perfect watch has been realized, and this is now available through the Starshine Group, a California-based marketing organization specializing in unique, innovative products.

The objective in producing the Sunwatch was to put an end to all the difficulties other watches create. For instance, with the Sunwatch you will never have to worry about accuracy again. For the rest of your life, you will know you are on time — almost to the second! You will also never again stop to check the time only to find that your watch batteries are dead. The Sunwatch powered by stored light energy, never needs a battery replacement.

Another important feature is that you don't have to strain your eyes to read the numbers in bright sun or dark rooms as with other digital and conventional watches. The Sunwatch has **4 built-in varying light intensities** which automatically adjust to the immediate light conditions, making it easy to read at all times, day or night. These necessities of correct timekeeping are now possible for the first time with this remarkable achievement in watch design.

Technical Data & Special Features:

■ **Tiny silicon solar power cells** are the incredible power source; they are constantly being energized from natural sunlight or even an ordinary light bulb while you are wearing your watch. The watch operates on this stored light energy and will work even after being kept in a drawer or suitcase for several days. However, should storage in darkness for a long period result in the watch losing its charge, a few hours in the sun (or overnight under a lamp) will charge it back up to normal (Note: if this happens and the watch display loses its charge due to a long period of darkness, the internal operation continues on keeping the same accurate time. Therefore upon re-charging the watch, the display readout will show the correct, up-to-date time, just as if the watch

had never lost its charge. This is because the display will automatically shut off at low charge levels, leaving enough energy to continue the internal time-keeping functions).

■ **No Resetting Needed Until 2100 A.D.!** Thanks to its own specialized **Micro-Circuit Computer**, the Sunwatch is electronically programmed to display the correct month and day with NO resetting for the next 123 years! (Of course, in 2 or 3 seconds, you can easily change the time [or any other display] at your option, should you need to change time zones, etc.)

■ **Permanently Sealed Lexan Module**, protected by U.S. and Foreign Patents until 1992, encapsulates all energy cells, solar panels, quartz crystals, Computer-On-A-Chip, Readouts, etc. This hermetically-sealed watch module is also filled with a special gelatin which absorbs tremendous shock, making the Sunwatch virtually the Most Indestructible Watch Ever.

■ **Completely Waterproof** (You can safely suspend it in boiling water for 30 minutes!) It's because of the permanent lexan seal mentioned above.

■ **Shock Resistant to 5000 G's** (You can literally crash it into a rug-surfaced brick wall at 90 M.P.H. without noticeable effect!)

Free Custom Engraving: At your request, each watch will be hand-engraved with your name (or any name you specify) to label and personalize it yours for a lifetime.



Limited Warranty is Your Protection. The Sunwatch is covered by a 2 year limited warranty issued by Riehl Time Corporation (Manufacturer of the Synchronar 2100), and included with your watch. A copy of the warranty may also be obtained free of charge by writing to Starshine Group, 924 Anacapa St., Santa Barbara, Calif. 93101. This warranty gives you specific legal rights, and you may also have other rights which vary from state to state.

Never Needs Batteries. Tiny silicon solar cells gather and store energy from sunlight, daylight, even an ordinary lightbulb. What a relief never to replace batteries!

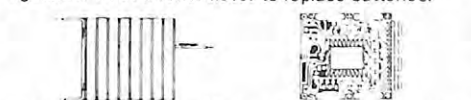

No Resetting — Ever. Micro circuit computer is programmed to display the correct month and day with no resetting until 2100 A.D.

■ **Temperature and Pressure Resistant** Freeze Sunwatch in a block of ice for a year or wear in 750 feet deep without damage.)

■ **Natural Side-View Window** lets you tell the *time, day, and date* without twisting your arm into an obvious, awkward position.

■ **Continuous Seconds Display** — Useful for pulse-taking, stopwatch timing, etc.

4 Different Readout Modes: Mode #1... Displays the time in hours and minutes (as shown). **Mode #2...** Displays the month and day in numerical form (i.e., 3:13 for March 13). **Mode #3...** Displays the day of the week (alpha form) and the seconds counting off (i.e., TU: 48 for Tuesday, and 48 seconds after the minute display in Mode #1.) **Mode #4...** Displays the leap year status, and the programmable speed calibration setting that the watch is currently set at. (i.e., 23:45. The first digit "2" means that this current year is 2 years after the most recent leap year. The next 3 digits tell you that your Sunwatch is operating at a speed setting of 3:45. This setting can be changed by you in just seconds to anywhere between a range of 0:00 to 7:77. This allows you to adjust your watch speed to compensate for local climatic and magnetic conditions, etc. After a little experimentation you will soon find the proper setting to keep your Sunwatch accurate to within an unprecedented one second per month. (That's 5 times better than the latest Quartz Accutron!)

The exciting Sunwatch offers split-second accuracy based on solar energy and advanced design features, all packaged in a striking, contemporary styled timepiece that is virtually indestructible even under the most severe conditions. The Perfect Watch of a lifetime for Business People, Professionals, Teachers, Athletes, etc.

The Philosophy behind the Watch and this advertisement. Our objective is to acquaint you in a straight-forward manner, with the honest facts and features of a timepiece that we (and several thousand current Sunwatch owners) genuinely believe to be the most advanced, most practical watch in production today. We have attempted to tell you as much as possible about the Sunwatch because we know it sometimes can be difficult to make an intelligent purchasing decision of this importance, from just a few words and pictures.

Should you decide to try wearing and using one, we will engrave your name on it at no charge, and send it to you by United Parcel Service (or USPS if UPS doesn't service your area). You then have 2 weeks to literally "try it on for size" and see for yourself how incredible this watch actually is. If you decide you don't care to keep it for any reason, you can return it to us (within 2 weeks of receipt) for a prompt refund, or a credit to your charge card.

Credit Card Orders Call Toll Free 1-800-235-6945, ext. 1045. Calif. Residents Call: 805-966-7187.

Note: Thousands of earlier models of this "pure-solar" timepiece have been sold nationwide for as high as \$500 or more. Recent cost reductions in certain components now make the watch much more affordable (see coupon below) and one of the best timekeeping investments you can make today.

Starshine Group.

924 Anacapa St., Dept. SW164, Santa Barbara, Ca. 93101

Please rush me _____ Sunwatch(s) in smart, slimly-styled stainless steel — for only \$129.95 each. I will wear the watch for 15 days; then if not completely satisfied may return it for a full refund of purchase price (less shipping charge). Please add \$3.95 per watch shipping & insurance.

Please send me _____ Sunwatch(s), gold plated with matching band — only \$159.95 each. If not completely satisfied, return it for a full refund of purchase price (less shipping charge). Please add \$3.95 per watch shipping and insurance.

Enclosed is \$ _____ Check or Money Order (Calif. residents add 6% sales tax)

American Express VISA (BankAmericard)
 Master Charge Diner's Club Carte Blanche

Credit Card # _____ M.C. Bank # _____

Issue Date _____ Exp. Date _____

Signature _____

Name to be engraved _____

Name _____

Address _____

City/State/Zip _____

© 1978 Starshine Inc.

CHOOSE YOUR FREE BUTTON!

(OVER 1,000 CHOICES)



PROMOTE • RAISE FUNDS MAKE PROFITS • IDENTIFY

It's America's most extensive line of badge and button making equipment. Useful for clubs, schools, business, individuals. Basic kit contains hand die press, color coded dies, badge parts and illustrated instructions. All for just \$24.95.



SEND TODAY

**BADGE-A-MINT, Ltd., Box 618, Dept. EL-119
Civic Industrial Park, LaSalle, IL 61301**

- Yes, I want to choose my FREE Sample Button. Send your 48—page color catalog.
 - I'm convinced, send me the complete BADGE-A-MINIT system. I've enclosed \$24.95 plus \$1.75 postage. Ill. Residents add 5% sales tax.
 - Use my credit card indicated below:
 - VISA (BankAmericard) Master Charge
 - American Express
- Credit Card # _____
 Inter Bank # _____ Exp. Date _____
 Signature _____
 Name _____
 Organization _____
 Address _____
 City _____ State _____ Zip _____

UNCONDITIONAL MONEY-BACK GUARANTEE

FREE CATALOG

OF FAMOUS
**Wright
Arch Preserver®
Shoes
for Men**



SEND TO:

Executive Shoes, Brockton, MA 02403
Dept. 539 Box 488

Send me FREE catalog of Wright Arch Preserver Shoes

Name _____

Address _____

City _____

State _____ Zip _____

Have you worn Wright shoes before?

Yes No



TIMELY WRIST CALENDARS Fit any standard watchband. Reversible gold or silver finish with large, easy-to-read numerals that won't wear off. Forms to fit wrist, won't wear out your cuffs. This inexpensive handsome 12-month set is only \$2.00 postpaid. Specify starting month. Order from MBM Company, Box 1646E, Mason City, Iowa 50401.

Iowa residents add 3% sales tax.

Elks Family Shopper consumer/news

charged. The Golden Age Passport will also entitle you to bring in a carload of guests. And you can get a 50 percent discount on fees charged for camping, parking, etc.

A wild horse for a pet? The government's "Adopt-a-Horse" program shows that wild horses (and burros, too) can make good pets or pack animals—or even show horses. The reason for the program is that shrinking lands and growing herds have made grazing a hit-or-miss matter. To solve this problem, the Interior Department's Bureau of Land Management rounds up the wild horses and burros from overpopulated areas. You can adopt one from any of the distribution centers in the far West or in Texas and Tennessee—that is, if you're qualified.

To find out how to apply, just write for the free booklet. Send a postcard to "Adopt-a-Horse", Bu-
(Continued on page 56)

Windmills on your mind?

Uniquely beautiful ornamental windmills. 4½ to 10 ft. high to perfect scale. Ideal for yard and garden.

FREE BROCHURE

Write to:
HOLST, INC. Dept. EK-119
1118 W. Lake, Box 370
Tawas City, Mich. 48763

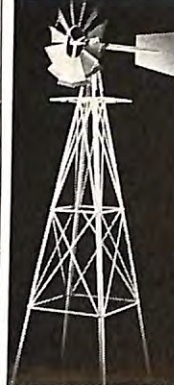

Now you can
have your
fireplace and
heat with
it too!

- EASILY INSTALLED
- CONTROLLED COMBUSTION
- LARGE HEAT CIRCULATING CHAMBER
- REVOLUTIONARY HEAT EXTRACT SYSTEM
- FITS MOST MASONRY FIREPLACES

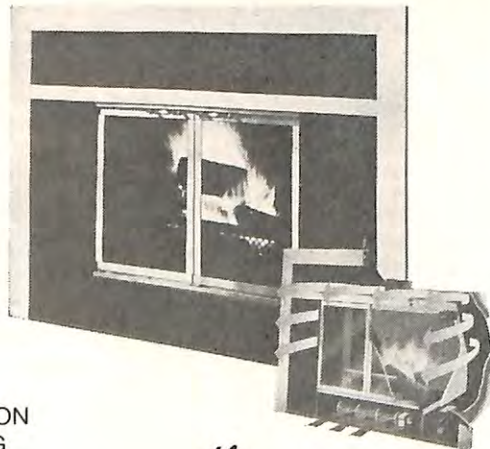

the MARK I FIREPLACE FURNACE

WRITE OR CALL FOR YOUR FREE COLOR
BROCHURE AND MEASUREMENT CHART

ROY SMITH
ENERGY ALTERNATIVES INC.
P.O. BOX 8
TUALATIN, OR 97062

DEALER INQUIRIES INVITED

503-638-8602

© Energy Alternatives Inc. 1979

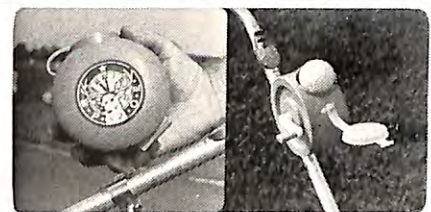

Unique New Product! A Perfect Gift For Every Golfer.

Keep your eye on The ball! The first rule of golf and so much easier to do when the ball is clean from tee to green. Every golfer has been annoyed by dry ball washers (or none at all at the ladies tees). With your own personal "Birdie..." golf ball washer mud and grass stains are no problem. A compact, durable product made in U.S.A. (Pat #4163299) that is the perfect gift for every golfer you know. Slides off bracket for storage or when using a riding cart. Once you try it you'll know—"Happiness is a Birdie...". Only \$9.95 + \$1.50 shpg. Colors—Red, Yellow, Brn, Blue, Green, Black. Buy 2 (One for yourself) for \$17.95 + \$1.50 shpg. Send Check or M.O. (Please state color choice).

A. J. DUDA & ASSOC., INC.
P.O. Box 21004, Lansing, Mich. 48909

MIGHTY 4-OZ. POCKET SCOPE



A miracle 8 power—with the panoramic view of a full-size binocular! The magic of powerful optics at your fingertips wherever you go. The 8 power Bushnell (Bausch & Lomb) Pocket Scope is great for theatre. Field of view at 1000 yards 437 feet. Use lens 24 mm by itself as a close-up magnifying glass to study stamps, coins. Use for many other fascinating adventures. 3 1/2" long, weighs only 4 oz., fully coated lenses. Complete with handsome zippered carrying case and wrist strap. Only \$34.95 plus \$2.50 p&h. Great Gifts. Send Check or M.O. 15 day money back guarantee.

HOLST, INC. Dept. EK-119, 1118 W. Lake, Box 370, Tawas City, Mich. 48763

Mystery Electronic Top

Greatest New Gadget In Years!



Handsome Gift Box

A Look into the Future!
Spins for days on Invisible Power
Unique Christmas Gift

What Makes It Go On and On and On and On at 2500 r.p.m. with no apparent energy source? **BAFLING BRAIN BUSTER** that **BUGS the BRIGHTEST**. Demonstrated at science fairs and conventions. The higher their IQ the more puzzled they are. **Perpetual Motion solved at last?** The answer to **UFO & Flying Saucer?** Let the whiz kids examine it, start it, stop it or whatever. **Psychic Power? Anti-Gravity? Scientific Breakthrough from Space?** You'll laugh at some explanations. Magic, Mystery & Science combined. Keeps spinning **WITHOUT ANY APPARENT ENERGY LOSS!** Fascinating fun at parties, science classes, etc. Carry in pocket ready to fool and entertain friends & wise guys. Never wears out. Spins for days on **Invisible Wireless Power** that you can defy anyone to See, Understand or Explain! Beautifully made with plastic base and saucer-shaped spinner. Patented. Complete with secret scientific explanation. Orders shipped promptly. **Money Back Guarantee**. Send check or money order for \$8.50 each. Add \$1.00 shipping & handling. Save. Get 3 for \$24.25 plus \$1.25 shipping; 6 for \$45.95 plus \$1.50 shipping. **Master Charge or Visa** accepted by mail or phone. Give card number & expiration. Phone: (313) 791-2800.

Johnson Smith Co., 35075 Automation Dr. DEPT. 7311, Mt. Clemens, Mich. 48043

PHONE TOLL-FREE FOR FREE 1980 CATALOG
1-800-247-2488

ASK FOR EXTENSION 90
(*Iowa Residents: phone collect — 515/674-3511)
Buy your folding tables and chairs direct — save dealer mark-ups!
Phone or write:
THE MONROE COMPANY
90 Church St., Colfax, Iowa 50054



FABULOUS PRICE BREAK!

NON-ELECTRIC THERMALUM™ HEAT SHEET RADIATES BODY HEAT TO KEEP YOU WARM!

SALE!
THOUSANDS & THOUSANDS SOLD FOR \$8.98
NOW ONLY \$7.95



ROOM TEMP. 50°

BED TEMP. 70°

© 1979, Encore House, Inc., Roberts Lane, Glen Head, NY 11545

- NO EXPENSIVE ELECTRICITY
- NO COSTLY FUEL
- NO BATTERIES
- NO WIRES
- NO POWER COSTS



NOW — a miracle of technological development in AEROSPACE INSULATION to protect astronauts from the incredible cold of outer space — THERMALUM HEAT SHEETS — defy bitter, all-winter, nighttime cold... let you sleep luxuriously in a cozy, toasty-warm bed as if you had used an electric blanket!

Practically weightless — actually lighter than your regular bed linens which fit over it — the THERMALUM HEAT SHEET is made from a soft, thermal/aluminum-like fabric that blocks out the cold. YET, INSTANTLY ALLOWS THE NORMAL 98.6° BODY TEMPERATURE TO REFLECT AND RADIATE ITS OWN WARMTH RIGHT TO YOU! No need for heavy blankets or comforters — a lightweight cover will do.

THERMALUM HEAT SHEETS are stain resistant and can also be used as a mattress pad. Make sure every size bed in your house has one. Try the THERMALUM SHEET and stay warm every night while your thermostat is turned down. Prove it without risk. If you're not warmly pleased, return it within 14 days for your purchase price refund (less postage & handling, of course). THERMALUM HEAT SHEETS make wonderful house-warming gifts, too. Special savings on extras. Order today and take advantage of our FABULOUS PRICE BREAK!

MAIL THIS NO-RISK COUPON TODAY

ENCORE HOUSE, Dept. TBH-4
Roberts Lane, Glen Head, N.Y. 11545

YES! I want to take advantage of your fabulous PRICE BREAK. Please RUSH me the incredible space-age THERMALUM HEAT SHEET(s) ordered below:

Fill in quantity desired:

(#110) Twin-Size only \$8.98 NOW only \$7.95
2 for \$14.95

(#120) Queen-Size only \$9.98 NOW only \$8.95
2 for \$16.95

(#130) King-Size only \$11.98 NOW only \$10.95
2 for \$20.95

Total number sheets ordered _____

Please add \$1 postage & handling for one sheet \$1.50 for two, \$3 for four.

I understand that if I'm not fully satisfied with my order, I may return it within 14 days for a complete refund of my purchase price (less postage & handling, of course).

Amount enclosed \$ _____ (NY residents please add sales tax). No C.O.D.'s please

CHARGE IT! VISA Exp _____
 Master Charge Date _____

Credit Card # _____

Name _____

Address _____

City _____ State _____ Zip _____

Mrs. Frederick D. Johnson
221 S. 23rd Street
West Highland Park
Anytown, Kansas 80940

1000 RETURN ADDRESS LABELS \$1.00

1000 gummed economy name and address labels printed in black

with ANY name, address, zip code. Up to 4 lines.
Order \$717 Set of 1000 Economy Labels (boxed) . . \$1.00



250 Self-Stick GOLD FOIL LABELS \$1.98

Gleaming gold foil labels stick to any clean, dry surface — need no

moistening. Rich black printing, classic border.
Order P6128 Set of 250 Gold Foil Labels (boxed) . \$1.98



250 Self-Stick WHITE GLOSS LABELS \$1.98

Glossy white self-stick labels cling to any smooth surface — no

moistening. Sharp black printing up to 4 lines.
Order P6030 Set of 250 White Gloss Labels (boxed) \$1.98

Walter Drake 329-A Drake Bldg. Colorado Springs, CO 80940

NAME _____
ADDRESS _____
CITY & STATE _____ ZIP _____

_____ \$717 1000 Labels @ \$1 each \$ _____
_____ P6128 Gold Foil Labels @ \$1.98 each \$ _____
_____ P6030 White Gloss Labels @ \$1.98 ea \$ _____

Add 20¢ per set for postage & handling \$ _____

SATISFACTION GUARANTEED Total \$ _____



Speaking of Conversation Pieces!

... Now You Can Own a Piece of History
**THIS IS THE AUTHENTIC ORIGINAL
 PAY TELEPHONE — COMPLETE WITH
 GRAFFITI, UNRETOUCHED AND
 IN GUARANTEED WORKING ORDER**

**UNBELIEVABLY PRICED AT
 Only \$69⁵⁰
 WHILE SUPPLY LASTS**

**IMPORTANT! STOCK
 IS FAST RUNNING-
 OUT. THIS MAY BE
 LAST TIME THIS
 OFFER APPEARS!**

Grand old pay phones retired from public service. Enjoy 'em as you remember 'em. Original finish — NOT repainted, with minor mars and scars of passing years. (Sorry, not responsible for graffiti!)

Parts renewed or replaced where necessary. Fully tested, guaranteed in perfect working order. No coin needed—but don't tell guests or kids! Just plug into any standard jack and bank coins toward phone bill. Huge capacity for nickels, dimes and quarters.

AN INVESTMENT as well as a novel decoration. Identical phones sell for much more than our low direct-to-you price. Collector's treasure—bound to gain in value. Quantity LIMITED—Order Today!

BEIGE, GREEN or BLACK (As Available) \$69.50
 EXTRA-CLEAN (No Graffiti) with ringer \$79.50
 DeLuxe CHROME with ringer (Very Scarce) Only \$99.50

**READY TO
 PLUG-IN and USE**

Compatible with all phone companies' equipment. **SATISFACTION GUARANTEED** or return within 30 days for full refund of purchase price.

**A TRULY UNIQUE GIFT
 FOR SPEEDIER DELIVERY
 PHONE TOLL-FREE and CHARGE IT!**
 (800) 645-6276*
 Sorry, No C.O.D.s
 Orders Accepted 24 Hrs — 7 Days
 N.Y. STATE ONLY: Call
 (516) 352-7000

(Div. of Latting Town Group Ltd.)

LONG ISLAND PHONE COMPANY Dept. PM-143
 121 Lakeville Rd., New Hyde Park, N.Y. 11040

Please PAY TELEPHONE(S) at \$69.50 Ship'g., Hndng. \$10
 rush EXTRA-CLEAN (Color _____) at \$79.50 ea. (Canada, Ha-
 me De Luxe CHROME PHONE(S) at \$99.50 waii, Alaska, \$20;
 Foreign, \$25)

PRINT NAME _____ CHECK OR MONEY ORDER ENCLOSED
 ADDRESS _____ Charge to: MASTER CHARGE (Bank No. _____)
 _____ ZIP _____ VISA AM EXP
 _____ DINERS CLUB

Sign _____ Expire _____
 Credit _____ Date _____
 Card No. _____

(N.Y. ONLY: Add 4% state tax, any local tax)

Elks Family Shopper consumer/news

reau of Land Management, P.O. Box 25047, Denver, Colorado 80225.

Before you go rushing off to apply for your wild horse or burro, remember one thing: these animals are wild. It takes considerable time and effort to tame an animal. But gentling and training a wild pet is well worth the effort. Some adopted horses have even won prizes in show competition. ■

CHRISTMAS GIFT OFFER

Collectable Full Color Embossed Art Prints of "Me and My Pal" Series by Norman Rockwell.



- Set of 4 8 x 10 prints - \$24.00
 - Single prints - \$7.00 each
 - Framed & Matted - \$28.00 ea.
- All Postage Paid
- CHARGE IT: _____ Exp. Date _____
 Visa
 Mastercharge

NAME _____
 ADDRESS _____
 CITY _____ STATE _____ ZIP _____

DENKER PICTURE FRAMING & GALLERY
 201-B E. Ft. Lowell Rd., Tucson, AZ 85705

AMAZING SPACE-AGE BLANKET COULD SAVE YOUR LIFE!



Metal-backed mylar blanket weighs only 2 ounces, reflects 90% of body's natural warmth. **A must for every car.** Don't freeze to death in stranded car on winter roads. Wrap up in blanket to stay warm with engine off. Avoid carbon monoxide suffocation, most frequent cause of death when marooned. Leave in glove compartment and feel secure.

Pocket-size protection for warmth in any emergency. Perfect for travelers, hikers, hunters, cyclers, yachtsmen, skiers. Money-back guarantee. \$3.00 each. Two for \$5.50. Add .50 for shipping.

Survival Systems Ltd.

Dept. E, 41 Topsfield Rd., Ipswich, Mass. 01938

MOTHER & PIGLETS



**UNUSUAL CONVERSATION
 PIECE. CAN BE USED AS
 A PAPERWEIGHT. FOR
 THE PERSON WHO HAS
 EVERYTHING. PALM SIZE.**

For immediate pre-paid shipment send \$4.00 (Va. residents add 4% sales tax). Master Charge and VISA Accepted. Sorry no CODs.



SPINELLA'S GIFTS
 608 Industry Dr., P.O. Box 9275
 Hampton, Va. 23661



A great contribution to any man's wardrobe

Made in America
 The original

MI-TIE HANGER

Solid walnut with beautiful hand rubbed finish, complemented with brass hook and cross bar. Plastic removable riders for individual hanging. 6" 25 tie size \$9.60, 10" 45 tie size \$11.60, 16" 75 tie size \$13.60 ppd. (less capacity with heavy ties). Send check or charge to Master Charge or BankAmericard. Quality Gift Catalog, 25¢.

SLEEPY HOLLOW GIFTS

6651 Arlington Blvd., E11-9, Falls Church, VA. 22042

CATALOG 32-PAGE



DAPPER All-Weather DOGGIE COAT

Forget the rain, sleet or cold! Your pet will be snug in this 4-legged, weather resistant coat of rugged nylon fabric. Weighs less than 3 oz. with detachable hood, knitted cuffs. Use over sweater for extra warmth. Full back zipper for easy-on/off. Fits male, female. For proper fit, measure from collar to tail. Satisfaction assured!

SIZES: 12-14-16—\$15.98 SIZES: 18-20—\$17.98
 (Add \$1.00 shipping)

CATALOG! Latest accessories, apparel for pup, kitty—25¢. Free with order.
 DEPT. 923, BOX 8850, METAIRIE, LA. 70011



"Announcing" NEW ELK Weather Vane

This handsome ELK Weather Vane has been Forged just for you! Now you can add the finishing touch to your home. Ornamental as well as useful. Let everyone see which way the wind is blowing. Precise wind direction at a glance. Balanced arrow responds to slightest breeze! This handmade sculptured Weather Vane is cast in rust-free aluminum. Carefully finished in satin black with Swedish iron finish on the Ornament. Maintenance Free to withstand decades of exposure. Your Elk Weather Vane is sure to add elegance to your home today! Complete with adjustable mounting base that will fit any roof. (Cupola base also available, specify) Arrow 24" long. Support 30" high. Easily assembled. Only \$36.50 plus \$3.50 shpg. Great Gifts. Send Check or M.O. Money back guarantee.

HOLST, Inc. Dept. EK-119, 1118 W. Lake, Box 370, Tawas City, Mich. 48763

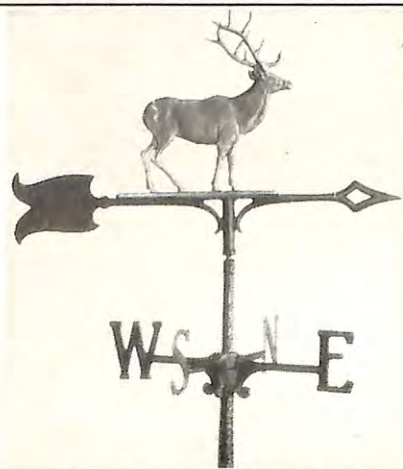

AMAZING AUTOMOBILE TIRE CLEATS GUARANTEE!

You'll Never Get Stuck In Snow Or Ice Again!

- Gives positive traction.
- Steel cleats won't break or slip.
- No jacking-up wheels.
- Goes on easily . . . releases quickly.
- Ideal for cars and light trucks.



Remember the last time you sat in your car helplessly spinning your wheels . . . trying to get out of a deep snow and ice bank. The more you gunned your engine, spun your wheels . . . the deeper you sank — STUCK! The only way to get going again was to dig out—or get a tow!

RELAX . . . TAKE IT EASY!

With our fantastic positive traction TIRE CLEATS ready for instant use, you'll never get stuck in snow or ice again. GUARANTEED! You won't have to dig out . . . you'll drive out in seconds with super tractor traction. Made like true tank/tractor treads of hardened steel, TIRE CLEATS bite deep into ice and snow at every turn of the wheel, thrusting . . . urging the car forward with no slipping, no skidding. **TIRE CLEATS install quickly without jacking up the wheels.** Fits cars and vans . . . even light trucks. Set of 2 TIRE CLEATS only \$6.99, well worth the price that saves you back-breaking shoveling and exhaustion and expensive towing charges. If you're not satisfied with your TIRE CLEATS, if they don't live up to the guarantee you'll never get stuck in snow or ice again, return them in 90 days for a complete refund of your purchase price (less postage and handling, of course). Order NOW!

© 1979, Encore House, Inc., Roberts Lane, Glen Head, NY 11545

MAIL THIS NO-RISK COUPON TODAY

**ENCORE HOUSE, Dept. TC-81
Roberts Lane, Glen Head, NY 11545**

Yes! Please RUSH me the positive traction TIRE CLEATS I have ordered below. I understand that if I'm not fully satisfied with my order, I may return it within 90 days for a complete refund of my purchase price (less postage and handling, of course).

- (#001) 1 Set of two TIRE CLEATS only \$6.99 plus \$1.25 postage and handling.
- (#002) **SAVE \$2.74!** 2 Sets of TIRE CLEATS (four cleats) only \$11.99 plus \$1.75 postage and handling.
- (#004) **SAVE \$9.97!** 4 Sets of TIRE CLEATS (8 cleats) only \$19.99 plus \$3 postage and handling.

Amount enclosed \$ _____ (NY residents please add sales tax.)
No C.O.D.s please.

CHARGE IT! VISA (BankAmericard)
 Master Charge

Credit Card # _____ Exp. Date: _____

Name _____

Address _____

City _____ State _____ Zip # _____

Do your heels ache?



Why suffer another day with sore heels (and even heel spur aches) when **Cushi-Heel Pillow** gives you quick relief while you walk or run? Developed by an athlete who suffered just as you do, and who couldn't find anything which helped. His U.S. patented (No. 3,984,926) pads are exactly the right shape, density and compression to cushion the weight your heels must bear. Mailmen, housewives, waitresses, sales people, nurses, bartenders, school teachers, people who *must* be on their feet all swear by them. Joggers, tennis, basketball, handball and racquetball players find they can now play in comfort, even with heel spur problems. If not satisfied, return within 10 days for full refund.

Calderon Products Co.
P.O. Box 5117, Akron, Ohio 44313

- Please send one pair of Cushi-Heel Pillows @ \$3.50 + 75¢ postage and handling.
- Save! Two pairs of Cushi-Heel Pillows for only \$6.50 + \$1.00 postage and handling.

Enclosed: check money order
 VISA Master Charge (MC-BSA No. _____)
 Card # _____ Expir. _____
 No COD's (Ohio residents add 4% sales tax).

Check size: Men's shoes size Women's shoe size
 6-7, 8-9 4-5, 6-7, 8-9
 10-11, 12-13

Name _____
 Address _____
 City _____
 State _____ Zip _____

WIND DIRECTION AT A GLANCE

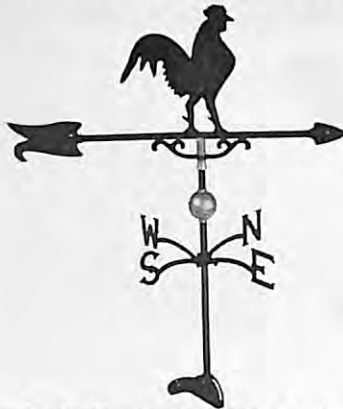

WEATHER VANES add the finishing touch to your country home! Perfect for your garage, farm or ranch too. Ornamental as well as useful. Precise wind direction at a glance. Balanced arrow on friction free bearing responds to slightest breeze! Made of aluminum with baked vinyl coating for rust free care with Gold-ornamental ball. Complete with mounting bracket and screws. Arrow 23" long. Support 24" to 27" high.

Crowing Rooster \$11.95 + \$2.85 p&h
 Galloping Horse \$11.95 + \$2.85 p&h
SAVE—two for \$23.95 + \$2.85 p&h

Great gifts!
 Send check or M.O. 15 day money back guarantee
HOLST, Inc. Dept. EK-119, 1118 W. Lake
 Box 370, Tawas City, MI 48763

See Advertisement Inside Back Cover

Haband's Polyester & Cotton
CORDUROY 2 pairs for only **24.95**
 Gentleman's Casual Slacks 3 Pairs \$37.25

HABAND COMPANY
 265 N. 9th St., Paterson, NJ 07530

Sirs: Please Send _____ pairs of Permanent Press Corduroy Slacks, for which I enclose \$ _____ plus \$1.25 toward shipping.

COLORS	How Many	What Waist	What Inseam
Buckskin Tan			
Hickory Brown			
Hunter Green			
Midnite Navy			

72K-022
 Name _____
 Street _____ Apt. # _____
 City _____
 State _____ Zip _____

• NON-POLLUTING • NO DEAFENING NOISE •

Quiet Power

12 VOLT Chain Saw

- Runs off battery in your car or truck
- Can cut a pickup load of wood, still leaves plenty of juice to start vehicle.
- Famous super-tough Oregon bar & chain.
- Approved for Highway Department use.
- Sold and used around the world.

MAINTENANCE-FREE • INSTANT START • NO FIRE DANGER • NEEDS NO GASOLINE

For Free Information, write:
 Tensen, Dept. 196, 1218 N.W. Glisan, Portland, OR 97209

• TOUGH, BUT NOT TOO HEAVY FOR LADIES •

COIN YEAR SET

CHANUKA WEDDING COMMUNION BIRTHDAY ANNIVERSARY BAR-MITZVAH CHRISTMAS GRADUATION CHRISTENING



Coin Year Sets, commemorating important events in your life, are ideal gifts which also INCREASE in value. Each set is mounted in a custom plastic holder and includes a Cent, Nickel, Dime, Quarter, and Half Dollar. All coins are in nice circulated condition with clear dates.

YOUR CHOICE

JAKE'S

5521 W. Belmont Ave.
 Dept. EL11
 Chicago, Ill. 60641
 312/725-2606

	Price Per Set
1934-1954	\$12.95
1955	\$14.95
1956-1964	\$11.95
1965-1969	\$ 4.95
1970	\$19.95
1971-1978	\$ 3.95

Please add 50¢ per set postage and handling. Illinois residents add 5% sales tax. Write for prices on dates not listed above.

Make beer at home

You can make a better beer than you can buy... stronger, more body and flavor... and save \$\$\$ too. Easy, fun, and all perfectly legal. Kit includes complete instructions, reusable brewing tank, fermentation lock, siphon, bottle capper and caps, and all ingredients. Ready for drinking in 3 short weeks... satisfaction guaranteed.

Standard Kit makes 24 bottles
 \$9.99 + \$1.50 postage and handling

Premier Kit makes 48 bottles
 \$15.99 + \$2.00 postage and handling

Ingredient refills available. New York Residents add sales tax. No C.O.D.'s

American Home Brews
 P.O. Box 22911 E, Rochester, NY 14692

GREAT GOLF GIFT

Whether you're just starting golf or are tired of toting a bag full of clubs, golf can be more fun and less tiring when you use the Adjustable*. A great club for practice- wherever you are, when the course is too wet for carts, for par 3 courses or traveling. The New Adjustable All-In-One golf club adjusts to driver, 3, 5, 7, 9 iron, sandwedge and putter. Only one club to carry and get used to, master and enjoy. Many golfers use it all the time and find their scores are just as good as with a full set. Money back guarantee. \$49.95; Christmas Offer—\$44.90, 2 for \$81.90. Add \$1.50 for postage. For MasterCard and Visa, send number and expiry date or call 219-234-4400. Please specify right or left handed & height for proper club length.

INTERNATIONAL GOLF PRODUCTS
 1865 J. Campeau Street • South Bend, IN 46617

Her Pride Will Show in Elkdom

18" Double Link Chain & Locket. Both Hand Polished, Gold Finish.

11th Hour Elks Emblem Encircled with Ten Simulated Diamonds.

Beautifully Gift Boxed In Time For Christmas.

ORDER NOW **\$9.95** PPD

SATISFACTION GUARANTEED.

Allow 2 Weeks Delivery.

SEND CHECK OR MONEY ORDER TO:
CREATIVE JEWELRY
 54 FAIRFIELD AVE. • PROVIDENCE, R. I. 02909

SOLAR POWERED AM RADIO

This attractive high quality radio has been designed to operate on Solar energy or a single 1.5 volt battery for night use. Ideal for camping at the beach or just general use. Sunlight is all that is needed to operate the radio. Price 39.95 (CA residence add sales tax). Order from SEM CON INC., Box 2751 Palos Verdes, CA 90274.



DO-IT-YOURSELF

FINE GRANDFATHER CLOCK KITS



STARTING UNDER
\$220

(including movement and dial)

- Factory direct prices
- Heirloom quality
- Solid 3/4" hardwoods: black walnut, cherry, mahogany, oak
- Easy to assemble, parts pre-cut
- Solid brass West German chiming movements
- Money back guarantee
- Prompt shipment

MASTER CHARGE and BANKAMERICARD/VISA ACCEPTED

Write for FREE color catalog

EMPEROR
CLOCK COMPANY
WORLD'S LARGEST MANUFACTURER OF GRANDFATHER CLOCKS

Dept. 209, Emperor Industrial Park
Fairhope, Alabama 36532

FUND RAISING Equip. and Supplies

BINGO EQUIP. and SUPPLIES
ARMCHAIR RACES
CHAIRS and TABLES

JAR TICKETS
BREAKOPEN TICKETS
CARDS and DICE
WHEELS and GAMING TABLES

TRI STATE SALES

494 Elm St., Manchester, N.H. 03101
Call Collect 603-668-0505



THE EXALTED RULER Charles M. Russell's Greatest Masterpiece

In 1912 he was asked if he would contribute something for the dedication of a new Elk's Temple. Russell painted the famous picture, "The Exalted Ruler", and signed it, "To My Brothers". This beautiful print is 15"x20" with wide margins, reproduced in full color on canvas. This would make a very fine gift for a special Elk member such as your Exalted Ruler, your past Exalted Ruler, or would be a fine addition to your Lodge.

One canvas print is \$15.50, each additional print is \$13.00 if ordered at the same time. Orders are mailed out the day after they are received. Mailing and handling incl. Satisfaction guaranteed. Send check to:

MOUNTAIN MAN PRINTS
BOX 6611 Rm. 11, GREAT FALLS, MONT. 59406

MINICUT ELECTRICAL SCISSORS



CUT UP! With New Minicut Electric Scissors

Cut in, cut through and cut out effortlessly with fast and accurate MINICUT battery-powered scissors. Powerful, lightweight and compact, MINICUT is ideal for all sewing and craft uses. A tough durable motor, encased in a hi grade plastic body, with double edge precision hard carbon steel blades, that slice through fabric and paper with ease. The push button switch eliminates the hand cramps so many people complain about after using the conventional scissors. An extra feature is the recessed and point-less blades for added protection. The perfect gift to give anybody. Operates on two pen lite AA batteries (batteries not included)... Order yours today... \$9.95 POSTPAID AIRMAIL... Hawaii residents add 4% sales tax.

Gifts Unique Co. P.O. Box 25805, Dept. E
HONOLULU, HAWAII 96825

CHRISTMAS SPECIAL ! The Halvorfold

Billfold
With Secret Money Compartment

Card Pocket

Loose-leaf Pass Case, Billfold
Card Case. Note Exclusive
features. Read Special
Offer below

Name, address and any Fraternal
Emblem in 25K Gold FREE



Outside closing Flap
means more Security

Exclusive Loose-Leaf Device
\$13.75 BLACK OR BROWN WATER BUFFALO

capacity 8-pass replaceable
12 Pass 25c Add'l
16 Pass 50c Add'l
20 pass 75c Add'l

Lodge No. under inside emblem 75c add'l.

Lodge No. with City under inside emblem \$1.25 add'l.

Social Security No. 75c add'l.

"CUSTOM MADE FOR ELKS"

"NOW in its 53rd year"—The HALVORFOLD billfold, pass case, card case. Just what every Elk needs. No fumbling for passes, just unsnap the Halvorfold and each pass shows under separate transparent face, protected from dirt and wear. Ingenious, loose leaf device shows 8, 12, 16 or 20 passes, cards or photos. Three card pockets, extra size bill compartments and secret flap to cover large bills. Only genuine leathers are used; tough durable but soft in texture. Nylon stitched.

Halvorsen, P.C.M., 4868 Victor St., Jacksonville, Fla. 32207
Dept. 137

Send the HALVORFOLD with goldstamping as below. If I decide to keep it I will send check at once. If not, I will return it within three days for full refund. Goldstamped with name, address and any fraternal emblem free. If you send cash with order, we ship postpaid. Parcel Post.

Name: _____ 25K Gold Inside Emblem: _____
Please Print

Address: _____
S. S. NO.

Free Examination! Send No Money—Pay No C.O.D.

Means exactly what it says. No strings. Mail coupon, Halvorfold comes by return mail. Examine it carefully. Slip in passes and cards. See how handy it is. Show it to your friends and note their admiration. Compare it with other cases at more money. We normally ship parcel post. (Postpaid on cash orders) This takes up to 4 weeks for delivery. However if you wish faster delivery please note additional charges below. REMEMBER: Money back if not satisfied.

PLEASE CHECK HERE:

- Black Buffalo \$13.75 Bro. Buffalo \$13.75
 12 Pass 25c Add'l 16 Pass 50c Add'l
 20 Pass 75c Add'l Elk Emblem Inside FREE
 Elk Emblem Outside 75c Add'l
 Lodge No. Under Inside Emblem 75c Add'l
 Social Security Number 75c Add'l
 First class .80 add'l

PLEASE USE ZIP CODE

Feet Freezing?



Step out in cozy comfort, whatever the weather. Damart's socks are the warmest in the world! That's because they're made from Thermolactyl, the miracle fabric worn by Mount Everest expeditions.

These socks protect and insulate your feet as no others can. The cushion double knit boucle Thermolactyl actually retains body heat. At the same time it lets perspiration evaporate so your feet always are snug and dry.

There's no weight or bulk, just comfortable warmth in any temperature. Damart socks are made in knee and ankle length at \$9.95 and \$6.95 a pair, plus handling and shipping—\$1.25 per pair. In navy only.



Damart, Inc. Dept. 60329
1811 Woodbury Ave.
Portsmouth, N.H. 03805

Please rush me my Damart socks. I enclose a check or money order for _____ pair(s).

Shoe Size _____ Ankle length Knee length

Print Name _____

Address _____

City _____ State _____ Zip _____

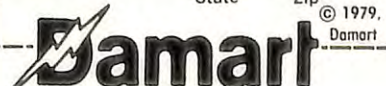

Sun Shield

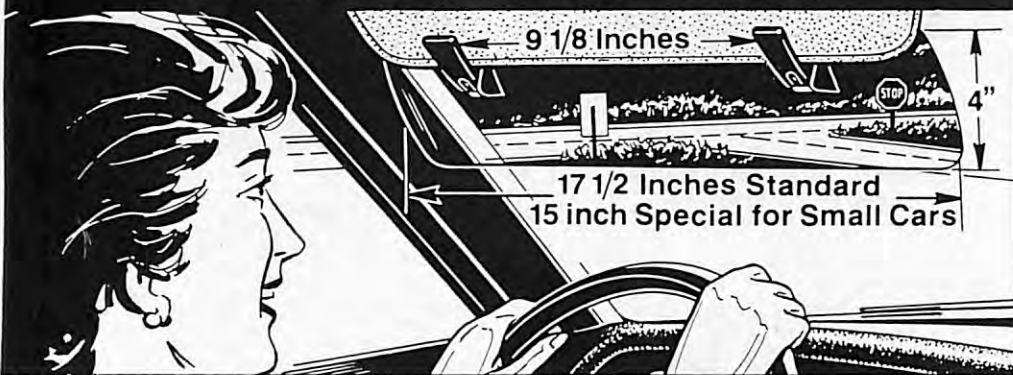

DOUBLES your driving COMFORT

- Reduces ALL GLARE and HEAT, front or side, Day or Night
- Accepted by leading safety authorities • Positive screw clamps hold securely
- Universally adjustable for look-through or shade-and-look-under.
- SATISFACTION GUARANTEED (Return within five days for full refund)

THE IDEAL GIFT • MOST ENJOYED • MOST APPRECIATED

Sun Shields, Inc. • Box 351 • Plymouth, MI 48170

Check or money order enclosed; Michigan residents ONLY add 4% tax.

\$5.00 for one Sun Shield, shipped postpaid promptly.

\$9.00 for 2 Sun Shields - Make your passenger comfortable, too!

\$42.00 Doz. (minimum, one order) for group buyers - fleet owners.



E Specify 15 in. LENGTH (not car model) for sub compact & small foreign cars.

Name _____ Street _____

City _____ State _____ Zip _____

See Advertisement Inside Front Cover

Haband's remarkable 100% man-made reproductions

ORDER DIRECT! **2** Pairs for **29⁹⁵** only

HABAND COMPANY

265 N. 9th St. Paterson, NJ 07530

Gentlemen: Please send me _____ pairs of the deluxe executive dress shoes as specified hereon, for which I enclose my \$_____ plus \$1.30 to help toward postage and handling.

PRODUCT NUMBER 72L-464

Take All Three — Only \$44.75

Color	Size	Width
Black 1		
Brown 2		
Dark Navy 3		

Name _____

Street _____ Apt. # _____

City _____

State _____ Zip _____

Or charge Visa Master Charge

Acct. # _____ Exp. _____

ELKS CHRISTMAS NOTION



ELKS LODGE RINGS **\$24.95**

(Actual Size as Shown)

Be proud and wear the Symbol of the Elks with this 18Kt Heavy Gold Electroplate Ring which features an expertly crafted Elk Emblem Set on a Genuine Onyx Stone, perfectly balanced by Two White Stones. Backed by the Manufacturer's LIFETIME GUARANTEE. Suggested Retail Price \$48.00, YOURS NOW at only \$24.95. Perfect as a Gift or Treat Yourself! Each order comes with a Complimentary Jewelry Catalog. Dealer inquires invited. SO ORDER NOW! SEND Name, Address and Ring Size(s) with Check or M.O.

TO: SKYLINE JEWELRY

Dept. N-79, P.O. BOX 93,

LAKE HIAWATHA, N.J. 07034

(N.J. Residents Add \$1.25 Sales Tax Per Ring)

RAMS-AIR Fireplace Furnace

HEAT YOUR HOME-SAVE MONEY

The amazing fireplace furnace that heats 2,000 sq. ft. at 1/2 the cost.

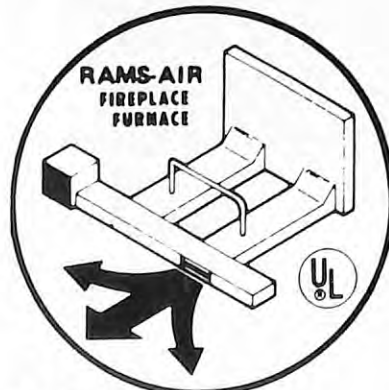

Easily Installed!
Fits Most Fireplaces!
15466 SW Summerfield Lane
Tigard, OR 97223
Phone: (503) 620-6031

Write or call for free brochure and measuring chart.

FREE OFFER TO COLLECTORS

MINNEAPOLIS (Special) — People who collect plates, bells, sculptures, figurines, stamps, and coins now can have free membership in Calhoun's Collectors Society.

President Stafford Calvin said, "I invite collectors to join Calhoun's while our membership rolls are open to new collectors."

Free membership brings you immediate information about current offerings in collectibles. Calhoun's members often save 20% to 50% below normal market price. In some cases, special offers are available in the U.S. only through Calhoun's.

To obtain free membership while the rolls are open, write to:

Calhoun's Collectors Society, Inc.
7275 Bush Lake Road, Dept. PB6
Minneapolis, Minnesota 55435

**Mandated by U.S. Congress
A Final Tribute to the
Ultimate American**



**Golden Limited Edition
JOHN WAYNE
MEMORIAL MEDAL**

*as issued by U.S. Government Mint
and electroplated with*

GENUINE 24-KARAT GOLD

To commemorate the first time the Congress has ever honored an American Film Star 'hero' on a Special Commemorative Medal, the American Treasury Mint has made arrangements to obtain a limited supply of the first-edition to be released by the U.S. Mint in Philadelphia, Pa. and to have them Gold Plated, mounted, and numbered.

Considering what John Wayne stood and still stands for—how he personified patriotism...Americanism...and true grit...to the rest of the world, we feel this limited edition medal is destined to become one of the most treasured collector's items of all time.

Certified First-Issue, Mint-Struck Offering— Individually Numbered

Each uncirculated, mint-condition medal we offer, honoring this beloved national hero is plated with the enduring gleaming beauty of real gold...which truly makes this a unique offering with both instant and heirloom value. Each is presented in a special collector's presentation case along with a numbered CERTIFICATE OF AUTHENTICITY certifying to its uniqueness as a first-mint offering. Truly a collector's item for every American...a treasured and prized keepsake for generations to come.

**First Time Available;
But Order Quickly—
Price Guaranteed Only 30 Days**

Even though the price of gold has skyrocketed to record heights, and the size of this striking medal is even larger than a Krugerrand, the American Treasury Mint guarantees to fill your order for this limited-edition at the offering price of only \$7.95 per medal, for a period no longer than 30 days following the date of this publication. Orders will be filled on a first-come first-serve basis, after release to us by the U.S. Mint, until the limited supply is exhausted. To make sure you do not miss out, send priority-reservation form immediately.

Reservation Procedure

Reservations are now being accepted for this historic 24kt. Gold Plated Commemorative John Wayne Medal. While every effort will be made to meet collector demand, there is a definite limitation on the number of medals which are being released through this limited edition offering. Accordingly, all reservations will be filled on the priority system described above, based on date received.

Important Note: Many collectors like yourself desire lower serial numbers. The serial number you receive will be determined by the date we receive your order. And of course, lowest assigned serial numbers are always shipped first. This is especially important if you intend to order several to pass on to your family as gifts and/or for their treasured heirloom value.

Satisfaction Guaranteed or Money Back.

American Treasury Mint is not affiliated with the U.S. Treasury or any other governmental agency
© 1979 FILM CORP OF AMERICA, Caroline Road, Phila., PA. 19176

ADVANCE REGISTRATION FORM

The American Treasury Mint, Dept. GJWB- 55
Caroline Road, Philadelphia, Pa. 19176
Please send me _____ 24 Karat Gold Plated John Wayne Commemorative Medal(s) in presentation case, and individually numbered at \$7.95 plus 75¢ postage, and handling each.

Save on quantity orders: Order 5 Golden John Wayne Commemorative medals at \$36.00 postpaid. Order 10 Golden Medals at \$60.00 postpaid for more savings. Order 25 Golden Medals at \$120.00 postpaid for even more savings.

Total enclosed \$ _____, PA residents add 6% sales tax. Check or money order, no CODs please.

If after receiving my order I'm not delighted, I may return it within 14 days for refund (except postage & handling.)
0006-015

CHARGE IT: Exp Date _____/_____/_____
 Visa American Express
 Master Charge Bank Number _____
 Credit Card # _____
 Sign _____
 Name _____
 Address _____ Apt. _____
 City _____
 State _____ Zip _____
 Canadian Customers please send orders to: Mail Store Ltd. Dept GJWB-55, 170 Brockport Drive, Rexdale, Ontario M9W 5C8 (Ontario & Quebec residents add sales tax).

"...now he belongs to the ages."



**Use your credit card!
CALL TOLL-FREE 24 HOURS
A DAY FOR IMMEDIATE SERVICE
DIAL 1-800-323-1717 oper.# 54
Illinois DIAL 1-800-241-8444**

Protects Car, Motorcycle, Boat, Machinery, Firewood — anything!
PORTABLE CAR GARAGE



ONLY \$5⁹⁸



Ice and snow shakes off easily — fold it and put it in your trunk. Ruggedly made to last for years!

Instant All-Weather Protection Wherever You Need It!

Huge 12' x 25' PORTABLE CAR GARAGE fits any make or model car (even station wagons and panel trucks) . . . Made of flexible, heavy-duty gauge clear polyvinyl with 8 reinforced grommets for secure tie-down. Stays pliable in sub-freezing weather, folds compactly for easy storage. Order extras to protect motorcycles, farm machines, outdoor furniture and barbecues . . . even small boats! Keeps precious firewood dry — a single cover protects 2½ cords of wood!

SUPER STRENGTH MODEL (12' x 25') ALSO AVAILABLE — made of extra strong, extra thick polyvinyl, with 8 reinforced grommets. Comes with protecting tape for secure coverage in severest weather — only \$8.98!

NO-RISK MONEY-BACK TRIAL

If you're not delighted with this rugged, durable, clear polyvinyl cover with dozens of uses, simply return it within 14 days for full refund, less postage and handling. But order now — there's plenty of nasty weather ahead — and plenty of things that need protection. Save when you order extras! Mail Coupon Now!

© 1979 National Home Products
 60 Wilton Road, Westport, Connecticut 06880

MAIL NO-RISK COUPON TODAY

NATIONAL HOME PRODUCTS, Dept. CG-29
 60 Wilton Road, Westport, CT 06880

Yes, please send me the Portable Car Garage(s) ordered below.

How Many?

_____ Portable Car Garage — \$5.98 plus 75¢ postage & handling

SAVE — Order 2 for only \$10.98 plus \$1 postage & handling

_____ Super Strength Model — \$8.98 plus \$1 postage & handling

SAVE — Order 2 for only \$16.98 plus \$1.25 postage & handling

If after receiving my order I'm not delighted, I may return it within 14 days for refund (except postage & handling).

Total amount enclosed \$_____ CT residents add 7% Sales Tax. Check or money order, no C.O.D.'s please.

Charge it please to: American Express Visa Master Charge (Bank # _____)

Card No. _____

Exp. Date _____

Name _____

Address _____ Apt. # _____

City _____ State _____ Zip _____

FOR THE ELKS MAN



Beautiful Elk styled gifts, all unconditionally guaranteed. Watch band & belt buckle are available in silver or gold plate; your choice.

Belt buckle \$17.95
 Watch band \$21.95

Price includes shipping and handling. Please allow up to 3 weeks delivery from order date. When ordering, specify gold or silver.

BankAmericard Visa Master Charge
 Fill in card numbers and expiration date below. Date

Send all orders to J&L Enterprises, P.O. Box 486, Montebello, CA 90640. (213) 724-6407.

GREENHOUSES

Use up to 40% LESS HEAT!!



All-bolted California Redwood and Fiberglass. Portable. Write to McGREGOR GREENHOUSES, Box 36-11B, Santa Cruz, CA 95063. (408) 476-5390

THE UNIQUE
Instant Speller

FASTER AND HANDIER THAN ANY DICTIONARY

6,000 MOST COMMONLY MISPELLED WORDS ARE CORRECTLY SPELLED, DIVIDED AND ACCENTED.

An aid to business and professionals, students, secretaries. Puts a world of words right at your fingertips. Works on touch method. Press down release tab with pointer on first letter of word wanted. In a flash find your answer. No pages to turn. For every home, every office, this side of genius. A perfect gift.

Credit Cards Accepted: BankAmericard (Visa) or Master Charge. Give Card No. and Exp. Date.

Only \$5⁹⁹ each. 2 for \$11 plus \$1 postage & handling. Calif. add 6% tax.

Instant Speller Co., Dept. E1179 • 125 So. Western Ave., Los Angeles, Calif. 90004



30-DAY MONEY BACK GUARANTEE.

SAVE HUNDREDS of DOLLARS



WITH BURKE SEAT-LIFT CHAIRS

Free Week Home Trial

Ask about Medicare coverage

Now's the time to save hundreds of dollars with a comfortable Burke recliner. Burke seat-lift chairs let you stand and sit when you want, with less strain. Power recline to any position, automatically elevating your feet and legs. Write for information and compare.

BURKE P.O. Box 1064, Dept. E1179
 Mission, Kansas 66202
 or call TOLL FREE 1-800-255-4147

TALL OR BIG MEN

Sick of Being Sold Short?



Most men's clothing stores successfully ignore the very existence of Tall, Extra Tall and Big Men by trying to sell you outdated styles . . . at outrageous prices.

Not The KING-SIZE Co. . . we cater to Tall, Extra Tall and Big Men with the world's best selection of fashionable clothing and shoes in hard-to-find sizes . . . all reasonably priced! Shirts, Sweaters, Suits, Slacks & Jackets with Sleeves to 38" . . . necks to 22" . . . inseams to 39" . . . waists to 60". Shoes and Boots to 16EEE.

All Guaranteed both Before and After Wearing. Washing and Dry Cleaning . . . or MONEY BACK.

FREE 100 PAGE CATALOG

My Telephone Number _____

Height _____ Weight _____ Shoe Size _____

NAME _____

ADDRESS _____

CITY _____ STATE _____ ZIP _____

The King-Size Co. 2549 King-Size Bldg. Brockton, MA 02402

**STATE OF FULFILLMENT
U.S.A.**



**Get Your Most Important Diploma!
A Degree of Retirement—
You've Earned It!**

A beautiful authentic addition to your other awards. A novel gift to yourself, relatives or friends. All ready to be filled out and framed. Price \$1.98. Postage and handling included
JOHNSON ENTERPRISES
P.O. Box 39, Dept. E, Palenville, NY 12463

New Natural Way To Sleep

100% Pure Cotton

Tee-PJ's resemble a T-shirt, but over a foot longer. Special knit gives when you move, eases up when you relax. No bind, no bunch, no chafe, no buttons, no ironing! Most comfortable sleeper you've ever worn or money back. (Great for Ladies, too). Choose snow white or soft blue. S-M-L-XL (to ensure best fit include height-weight when ordering.) Order NOW, while prices include postage/handling!

\$9. ea 3 for \$20

Long sleeve style (not shown)

\$11 ea 3 for \$27

WITTMANN TEXTILES

Dept. 289, Hobe Sound, Fla. 33455



**NEW!
High Limb™
CHAIN SAW**

The Only
Far-Reaching
Chain Saw
Technically
designed
for hand use

Now you can cut down branches and limbs up to 30' and higher while standing safely on the ground. Revolutionary new chain blade has all the traditional fast cutting qualities of a chain saw blade, but has been technically redesigned for hand use with "two way cutting action". The 22" chain is attached on each end to strong 25' polypropylene control lines, and a sandbag safety weight is attached to the end of one control line. Simply toss the safety weight over the branch or limb you want to cut down, and pull alternately on control lines. Because you stand to the side of the limb you are cutting (never stand directly under it), you automatically undercut the limb and avoid "peel-back".

Outfit comes complete with comfortable handstraps. Works quickly and smoothly on everything from small branches to large limbs, hardwood or softwood, live wood or dead wood.

Avoid the hazard of climbing ladders and avoid expensive tree service bills. . . the HIGH LIMB CHAIN SAW can pay for itself in a morning's use.

IMPORTANT USE DURING FUEL SHORTAGE—Use your HIGH LIMB CHAIN SAW to cut down dead limbs and lower limbs for firewood. Your trees will continue to grow more healthy and stronger than ever, and continue to provide you with future fuel.

COMPLETE HIGH LIMB OUTFIT—Only \$21.95 plus \$3 shpg. Send check or M.O. 20 day money back guarantee.

HOLST, INC. Dept. EK-119, 1118 W. Lake, Box 370, Tawas City, Mich. 48763



AS ADVERTISED ON TV

Bearcat®

210

The whole world of scanning at your fingertips.

The Bearcat 210 is a sophisticated scanning instrument with the ease of operation and frequency versatility you've dreamed of. Imagine selecting from any of the public service bands and from all local frequencies by simply pushing a few buttons. No longer are you limited by crystals to a given band and set of frequencies. It's all made possible by Bearcat space-age solid state circuitry. You can forget crystals forever.

Pick the 10 frequencies you want to scan and punch them in on the keyboard. It's incredibly easy. The large decimal display reads out each frequency you've selected. When you want to change frequencies, just enter the new ones.

Automatic search lets you scan any given range of frequencies of your choice within a band. Push-button lockout permits you to selectively "skip" frequencies not of current interest. The decimal display with its exclusive "rolling zeros" tells you which channels you're monitoring. When the Bearcat 210 locks in on an active frequency the decimal display shows the channel and frequency being monitored.

Only Bearcat's vast experience in scanner technology combined with our expertise in the design and application of solid state circuitry could have advanced scanning to this state of the art. But you should have expected this from Bearcat. We invented scanning, and it's our only business.

Bearcat® 210 features

Deluxe Keyboard — Color coded so you won't miss the keys and slanted for visibility and convenience, the keyboard makes programming as simple as using a push-button phone.

Crystal-less — Bearcat's solid state circuitry with 5 custom designed chips lets you select from all local public service frequencies without ever having to buy a crystal.

5 Band Coverage — Includes Low, High, UHF and UHF "T" public service bands, the 2-meter amateur (Ham) band, plus other UHF frequencies.

Decimal Display — The large decimal display shows frequencies and channels programmed and being monitored.

★ One year factory warranty. All merchandise new in factory sealed cartons.

★ From Scanner World, all of the above can be yours for only \$199.99 plus \$3.00 shipping. Call 518-436-9606 now to place a Master Charge, Visa, BankAmericard or COD order by phone. Direct mail orders to the address, including money order, credit card information, or we will ship your order COD. New York add 7% sales tax. Catalogue free upon request.

Rolling Zeros — Exclusive Bearcat feature tells you which channels your scanner is monitoring.

Automatic Search — Seek and find new, exciting frequencies.

Track Tuning — Bearcat's patented track-tuning provides full-band coverage on every band — you hear more in each band.

Tone-By-Pass — Scanning is not interrupted by mobile telephone tone signal.

Selective Scan Delay — Adds a two second delay to prevent missing transmissions when "calls" and "answers" are on the same frequency.

Space Age Circuitry — Custom integrated circuits . . . a Bearcat tradition.

AC/DC — Use the Bearcat 210 at home or in your car. UL Listed/FCC Certified — Assures quality design and manufacture.



SCANNER WORLD, USA
10-E New Scotland Ave.
Albany, N.Y. 12208
518-436-9606

SAVE ON... ACCORDIONS
STANDARD AND ELECTRONIC

IMPORTER-TO-YOU PRICES!

Buy Direct From Importer. Over 30 models—popular colors, sizes, switches, features! Famous makes for students, teachers, professionals. Save! No middleman profit. 5 day home trial. Easy terms. Trade-ins Welcomed. Satisfaction assured. Write Today.

5 DAY HOME TRIAL—EASY TERMS

FREE Color catalogs and "Direct" Price List

Accordion Corp. of America — Dept. K-119
5535 Belmont Avenue, Chicago, Ill. 60641

Send FREE CATALOGS /Money Saving Prices on:

Standard and Electronic Accordions
 Hohner 'button' Accordions Cordovox

Name _____

Address _____

City _____ State _____ Zip _____

Check if you have a Trade-in!

CORDOVAX

Combines Organ with Accordion. Buy from A.C.A. and Save Big Money. Check Coupon.



NOW—Popular Button-Type HOHNER ACCORDIONS at DISCOUNT PRICES! Check Coupon.

HAPPY HANG-UPS

Whimsical, full-color plaques to give to special friends. One features a smiling airplane and proudly declares: "Pilots are just plane people with a special air about them." The other depicts a grinning adding machine and the observation: "Accountants are important sumbodies with well balanced personalities." Both framed plaques are 9½x12" and ready to hang.

#HU-5005 Pilot \$5.95 postpaid

#HU-5007 Accountant \$5.95 postpaid



BILL COLLINGWOOD

Dept. E1179, Box 320, South Miami, Florida 33143

In a RUSH! Add \$1.00 EXTRA per order! "The YOUUnique Catalog" 25¢ or free with order.



READ-EAT-WATCH TV



**IN
RELAXED
COMFORT**

A joy for bed readers, a must for convalescents and a welcome gift for all. This elegantly grained mahogany plywood Folding Back Rest is super size, 16"x24" high. A full 4 to 6" higher than other back rests. It gives full pillow support to head and back for firm sitting-up comfort. 5-adjustable positions. Vertical elastic cords hold your own pillow securely in place. Non-skid base. Conveniently light, it folds wafer-thin—no storage problem. **\$14.98.** Order from this ad, we'll pay postage, ship promptly. NJ residents add 5% tax.

Send Check or Money Order to — **Better Sleep Inc.** MONEY BACK GUARANTEE QUALITY PRODUCTS SINCE 1951
Box ET, New Providence, NJ 07974

**Personalized 2 1/4" wood
GOLF GIFT!
YOUR NAME HERE**

**Personalized Golf Tees
The Perfect Xmas Gift for Golfers**

Package of 50 golf tees only \$5.95 plus 95¢ postage.
Additional orders \$4.95 plus 50¢ postage.
Credit cards accepted

**ORDERS SHIPPED 1st CLASS IN 72 HOURS
SATISFACTION GUARANTEED**

Send golf tees to _____
Address _____
City _____ State _____ Zip _____

Name(s) on golf tees _____
JOMAR INDUSTRIES, INC.
460 S. 10th Avenue Dept. 33
Mt. Vernon, N.Y. 10550

Orders received by
Dec. 19 guaranteed
delivery by Xmas

AN INCREDIBLE LIGHT



OATLAST
ONLY \$8.99
NO BATTERIES
NO CHARGERS
NO FAILURES

DEPENDABILITY FOR SALE

NEW USE OF OLD PRINCIPLE results in amazing light that needs no battery. Nothing to corrode, rust, or leak—Ever! Hidden miniaturized generator provides a piercing beam with easy strokes of retractable lever. NEVER NEEDS BATTERIES! Reliable in emergencies since independent of outside power. Small price to pay for security. Makes a fine gift. Order today! CEDARHILL; 12641 Jerome Lane, Garden Grove, Ca. 92641.

Send To: CEDARHILL, Dept. EL109
12641 Jerome Ln., Garden Grove, Ca. 92641

YES — RUSH DYNAMO LIGHTS
at \$8.99 EA. (Ca. res. add 54¢ tax)

If I am not completely happy with my purchase I can return it within 15 days for a full refund.

Name _____
Address _____
City, State _____ Zip _____

INVENTORY ADJUSTMENT SPECIAL!

**PILOT'S GLASSES AT
UNBELIEVABLE PRICES!**

**ONLY
\$6.95**

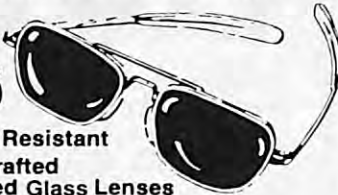

- Impact Resistant
- Handcrafted
- Polished Glass Lenses
- Hardened Metal Frames
- Money Back Guarantee

To order, send check or money order (include \$1.00 for postage and handling) to U.S. Optics, Dept. 314, P.O. Box 14206 Atlanta, GA 30324. (Please specify gold or silver frames.) SPECIAL: Order now and get TWO PAIR for \$13 plus one dollar handling charge.

FREE! During this limited offer.
Deluxe velour lined protective case. A \$3.00 value.
LIMITED OFFER FROM U.S. OPTICS

MEN...WOMEN...

**SAUNA SLIM SUIT
WORKS IN MINUTES
TO MELT INCHES OFF!**

Join the Slim Set Today... Lose inches quickly and effortlessly. Sauna Slim Suit works like a Sauna bath... Locks in body heat as you shrink inches off... Wear it while you work or just relaxing... Sauna Slim Suit does the work, you don't... To help keep your new slimmer figure receive our unique slim guide absolutely free. Start losing inches instead of time... Order today. One size fits all. Only \$9.98. Special 2 for \$17.98. MONEY BACK GUARANTEE... Send to: Rush Industries, Inc. Dept. HR-72A, 300 Park Ave. S., New York, N.Y. 10010



Excellent Christmas Gift

Square Note



Keep this compact cube close to phones in home or office

Great for taking messages or leaving notes.

Available in clear or smoked plastic.

CUBE SIZE 3 1/2" x 3 1/2"

Filled with your choice of 700 sheets of white or assorted color paper.

SATISFACTION GUARANTEED

\$4.95 each + \$1.50 shipping.

The Cargo Co.
Box 33084 Dept. C11 Paper refills \$2.00 each + 50¢ shipping
North Royalton, OH 44133

**Fishin' is More Fun WITH A
SPINNING FISHING BOBBER**

Patent No. 3,613,289

CAST FARTHER... FISH ANY DEPTH
SIMPLE INSTRUCTIONS INCLUDED
IDEAL CHRISTMAS GIFT!
MONEY BACK GUARANTEE

**\$2.00
EA.**

CORONET DISTRIBUTING CO.

P.O. Box #6698 • Boise, Id. 83704
Enclosed find \$_____ for _____ Bobbers
CHECK OR MONEY ORDER

Name _____
Address _____
City _____ State _____ Zip _____

**WORLD'S FINEST
12 VOLT**



BATTERY POWERED

CHAIN SAW
The Perfect Christmas Gift

IDEAL FOR

- Woodcutters
- Sportsmen
- Carpenters
- 4 Wheelers
- Farmers
- Landscapers

BUILT TOUGH, LIGHT WEIGHT

SPECIAL INTRODUCTORY OFFER

\$99.95

Postage Paid To Your Door

FOR FREE BROCHURE OR TO ORDER
CALL **1-503-638-8602**

THE EARTH SAW
P.O. BOX 8
11975 S.W. HERMAN ROAD
TUALATIN, OREGON 97062

L.L.Bean®

Outdoor Sporting Specialties

Flannel Pajamas

(For Men and Women)



Comfortably warm for cold winter nights. Amply cut from 100% cotton flannel. Sanforized. Button front top with breast pocket. Draw string waist. Women's have elasticized waist.

Women's sizes: Sm. (30-32), Med. (34-36), Lg. (38-40). Men's sizes: A (110-135 lbs.), B (135-165 lbs.), C (165-185 lbs.), D (185-210 lbs.). \$13.75 ppd. Men's Long sizes for 6' and over. Sizes B, C and D only. \$14.75 ppd. Colors, Red, Light Blue, Tan.

Please Ship Postpaid SEND FREE CATALOG

Women's Flannel Pajamas

Size _____ Color _____

Men's Flannel Pajamas, Reg. _____, Long _____

Size _____ Color _____

Check Enclosed Master Charge

VISA American Express

Card Number _____

Exp. Date _____

Name _____

Address _____

City _____

State _____ Zip _____

L. L. Bean, Inc.

7171 Cedar St., Freeport, ME 04033

NOW--GET GIANT 7-FT. LIFESIZE PICTURES FROM YOUR TV SET!

AVAILABLE ONLY BY MAIL ORDER

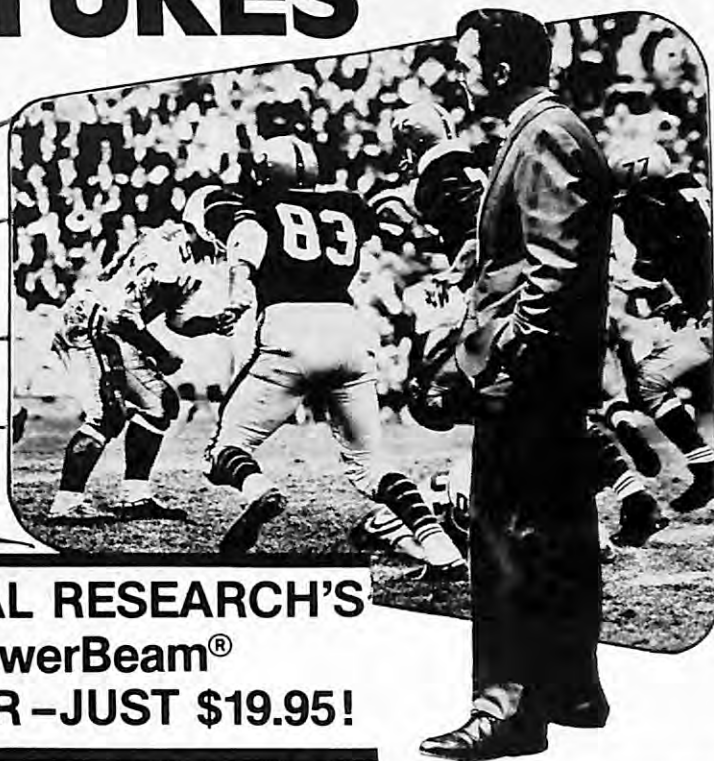
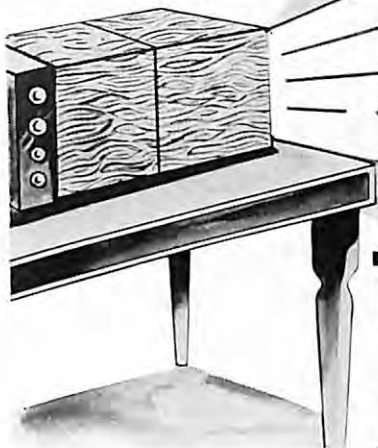

INTERNATIONAL RESEARCH'S NEW PowerBeam® TV PROJECTOR—JUST \$19.95!

Yes, it's hard to believe—but it's true! For just \$19.95 you can own International Research's all-new, revolutionary PowerBeam® TV Projector. You can enjoy giant 7-foot TV pictures—in brilliant color or super-sharp black-and-white—projected right onto any wall in your home.

THE PowerBeam® PROJECTOR—

If you're a TV fan (and who isn't!), you more likely already know that life-size home TV projectors can cost from \$1500 to over \$4000. And that hefty price tag is more likely why you've done without the enjoyment of life-size TV pictures until now. But the new PowerBeam® TV Projection System changes all that!

If you're a sports fan, the PowerBeam® TV Projector will add a spine-tingling new dimension and realism to your TV sports viewing. In fact, PowerBeam® TV projection is so life-like that you'll feel almost like you're right out there on the field with the players. You'll see and appreciate action and plays that would have escaped your notice on ordinary sized TV sets.

And watching TV movies and your favorite regular shows on new PowerBeam Projection TV is a very special, very thrilling experience. It won't seem like TV at all. It will seem more like you're in a movie theatre. And in a sense you will be because PowerBeam® Projection TV converts any room in your home into a theatre! You'll see everything better. And you'll appreciate the shows more because a bigger picture makes any show more convincing and more real.

HOW PowerBeam® WORKS—

The International Research PowerBeam® TV Projection System works just like most other TV projection systems. Most TV projectors costing thousands of dollars use a conventional small screen TV set as their picture source. PowerBeam® does the same—but it uses your present color or black and white TV as its picture source. And, since you already own your TV, that's a big saving right there.

PowerBeam® fits right over your TV screen (from 9" to 19") and traps all the brightness that's ordinarily wasted in a special chamber. Then it focuses the image through a unique, extra-large 5" optical-quality spherical concave projection lens. And you might be interested to know that this special projection lens was developed through computer and space-age technology. The picture is then beamed across the room, converting any wall—or a screen or sheet—into a giant 7-foot (diagonal measurement) life-size TV picture. The result? Super sharp, bright, clear and brilliant TV—in both color and black-and-white.

IMPORTANT FACTS ABOUT OUR NEW PowerBeam® TV PROJECTION SYSTEM—

The first thing we'll tell you is that we promise not to try and fool you by saying that PowerBeam® is something more than it really is. We'll openly admit that PowerBeam® is not as fancy as the sets that cost thousands of dollars. In fact, to be perfectly frank from the start, here are some examples of how we've simplified PowerBeam®'s design to save you money. PowerBeam® doesn't have many of the complicated electronic controls that more expensive sets have. But remember, those fancy controls and gadgets often go haywire, causing you to foot the bill for repairs and adjustments. And PowerBeam® doesn't feature such luxuries as digital channel readout or wireless remote control. On the other hand, our PowerBeam® TV Projection System doesn't have a hefty price tag that runs into the thousands of dollars. To enjoy these enormous savings and PowerBeam®'s magnificent picture, requires only your willingness to adopt one of two easy options: If you have a portable TV set, just flip it over on its top. (It continues to work and tune as usual). If you have a large set, you will require a small technical adjustment that can be done routinely by any qualified TV repair man.

It's relatively easy—and when it comes to what really counts in projection TV—the picture itself and your enjoyment of it—we're sure you won't find any faults with PowerBeam®'s performance. You're sure to like saving all that money, too!

AVAILABLE ONLY ON THIS DIRECT-BY-MAIL OFFER

Another reason our price is so low is because of an important marketing decision made by International Research. We decided to sell our PowerBeam® TV Projection System direct to you, the consumer, by mail order. We save the tremendous expenses of setting up a nationwide chain of fully staffed display rooms. And we save the expenses of a national advertising campaign which could cost millions of dollars. International Research passes these savings directly back to you. And that's one of the major reasons you pay only \$19.95 for the complete PowerBeam® TV Projection system.

30-DAY FREE TRIAL—PUT US TO THE TEST

We are so sure that you will appreciate PowerBeam® and the spectacular difference it makes in your TV viewing that we want you to experience it for yourself. In fact, we are sure enough to send it for you to

use—without financial risk—for a full 30 days. And how many manufacturers of high-price sets will dare to make that offer? Use PowerBeam® and judge its performance. Watch your favorite sports programs, movies, regular shows and entertainment specials on it. Thrill to that special added dimension that only giant-size pictures can bring to TV watching. Then, if you can bear to part with your PowerBeam® Projector—if you're unhappy for any reason—just return it—and we'll rush you a full, unquestioned refund of your small \$19.95 purchase price.

HOW TO ORDER—

To get your PowerBeam® TV Projection System for this no-risk 30-day home trial, send your check or money order for only \$19.95, along with \$3.00 for shipping and handling expenses (a total of \$22.95), with the coupon below or you can charge to your BankAmericard, Visa or MasterCard card.

We'll rush your PowerBeam® TV Projection System straight to your door, and you can put it through its paces in your own home. Without financial risk. Why pay thousands of dollars of your hard-earned money for life-size television when PowerBeam® gives you the same giant picture—but for only \$19.95 complete? And remember, if you're unhappy with its performance—for any reason—just return it within 30 days for a prompt, unquestioned refund of your entire purchase price!

IT REALLY WORKS! READ WHAT SATISFIED OWNERS SAY ABOUT THEIR PowerBeam® TV PROJECTION SYSTEMS!

PowerBeam® TV Projection System shatters the price barrier for giant, life-size home TV. Just \$19.95—complete! And you'll be thrilled with the brilliant, crystal clear, giant pictures you'll get. Here's what PowerBeam owners say—

"I was amazed! I felt like I was actually on the field with the players when I watched the Superbowl on my PowerBeam® Projector. How can you do it for only \$19.95?" —H.G.—

"All my friends are thrilled. They love to come over and see all their favorite shows projected to life-size. I didn't tell them my PowerBeam® TV Projection System cost only \$19.95. I knew they wouldn't believe me." —S.L.—

"At last someone has done something about the ridiculously high costs of projection television. Thank you for putting your PowerBeam® TV Projection System on the market!" —J.M.—

"I was skeptical about your low price. But I couldn't afford to pay two or three thousand dollars for a projection television system, so I bought PowerBeam®. And I'm really happy with it. It's everything you say it is—and more!" —R.S.—

NO-RISK RUSH ORDER FORM

INTERNATIONAL RESEARCH, Dept. RS-4085
535-5th Avenue, New York, N.Y. 10010

Yes, rush me one of your new PowerBeam® TV Projection systems, at only \$19.95, plus \$3.00 to cover shipping and handling expenses. I understand that if I'm not delighted with my PowerBeam® Projector, for any reason, I may return it within 30 days for a full, prompt, unquestioned refund.

I enclose full payment of \$ _____
(N.Y. residents, add sales tax)
Please charge to my: check one)
_____ BankAmericard _____ Visa _____ Master Charge
Card # _____ Exp. Date _____
Interbank No. (Master Chge. only) _____

Print Name _____
Street _____
City _____ State _____ Zip _____

BURPEE SEEDS GROW **Burpee's** BURPEE SEEDS GROW

new 1980 Seed Catalog-FREE

Featuring new exciting vegetable and flower varieties for home gardeners.

The new 184-page Burpee Catalog is a comprehensive planting and growing guide with over 1800 vegetables, flowers, fruits, shrubs and trees. Plus helpful hints from Burpee's horticulture experts on how to have a more productive garden. Send for your free copy today, and it will arrive in your mailbox in early January.

If you ordered from Burpee last year, you will automatically receive your free Burpee catalog in 1980. © Burpee Seed Co. 1979



BURPEE SEED CO.

1430 Burpee Bldg., Warminster, Pa. 18974; or Clinton, IA 52732; or Riverside, CA 92502 (Please mail to nearest address)

Send the 1980 Burpee Catalog FREE.

Name _____ (Please print)
Address _____
City _____ State _____ Zip _____

Unique COIN COUNTER & PACKAGER

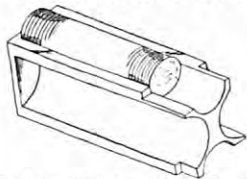

\$3.00

2 for \$5.00
3 for \$6.00

plus .50 (p-H)
Pa. residents add 6% sales tax

Enables you to accurately count pennies, nickels, dimes and quarters in standard amounts and easily place them into standard tubular coin wrappers. Plastic and pocket size. Dealer inquiries invited.

CHESSMAN CORP., Dept. E-11
307 Susquehanna Ave., Wyoming, Pa. 18644



"SAVE YOUR HEART"

with a **STAIR-GLIDE®** Stairway Lift
RENTAL-PURCHASE Program Available

America's largest selling stairway lift. Ideal for people who cannot or should not climb stairs. Easily installed in less than 2 hours without damaging stairway. Runs off household current. Choose from Deluxe or Economy models.

AMERICAN STAIR-GLIDE® CORP.
4001 East 138th, Dept. E119,
Grandview, Missouri 64030

CUSTOM MADE EMBLEMS

Organizations, Schools, Churches, Commercial Fund Raising and etc. Free Brochure Dept. CM 10E



EMBLEMATIC JEWELRY \$15 ea. \$1.00 ea. p.p. 25¢
ELKS, K of C., MASONS, ETC.
Free brochure Dept. EJ 12E
Fraternal Wholesale Jewelry Mfg. Co.
P.O. Box 8123, Cranston, R.I. 02920
(401) 942-4591

WINDWATCH™ ANEMOMETER—WIND VANE \$29.95



Neon lights in indoor indicator show wind speed and direction. Decorative indicator with gold dial in dark mahogany case. Designed for desk or wall mount. Outdoor instruments of durable aluminum with electric parts enclosed in rigid vinyl housings. Easy to assemble and install. Attach directly to roof or pole. Comes with wire and materials for installation up to 60 feet. Uses regular 120V AC. Unique low amp circuit for absolute safety. A fascinating home addition. Five year limited guarantee. 15 day trial. Satisfaction or money back. Only \$29.95 plus \$2.00 shpg. Check, Visa/Mast. Chg. Give Number and Expiration Date. Immediate Delivery.

WINDWATCH MFG. Dept. E-9, 104 Helmann
San Antonio, Texas 78205

New sleep comfort without extra pillows.



Enjoy new comfort with your back, shoulders and head gently raised and cushioned on this light buoyant foam wedge. Provides an even, gradual slope for more healthful, restful sleep. **Head Elevation** eases discomforts associated with diaphragm hernia, hypertension, acid regurgitation, breathing, bronchial and heart ailments. **Leg Elevation** eases varicose, circulatory and swelling leg discomforts. 27" long, 24" wide. Washable zipper cover. **FOAM-SLANT** is available in heights most often prescribed by doctors. Order 4" high for two pillow users \$16.00, 7 1/2" high for three pillow users \$19.00; or choose extra high 10" at \$22.00 or 12 1/2" at \$25.00. Extra covers \$7.98 each. Order from this ad, we'll pay postage, ship promptly. NJ residents add 5% tax.

Send Check or Money Order to — **Better Sleep Inc.** **MONEY BACK GUARANTEE** **QUALITY PRODUCTS SINCE 1951**
Box EN, New Providence, NJ 07974

NEED HELP GETTING UP?

TRY A CUSHION-LIFT® CHAIR

Now you can get up at the touch of a button — easily, securely, and without pain or effort. No more waiting for help . . . you can be independent again.

- Medicare coverage in most cases
- Free home demonstration — no obligation
- Free color brochure

CALL TOLL FREE: **1-800-558-2151**



ORTHO-KINETICS, INC.
P.O. Box 2000-EL11
Waukesha, WI 53186
Wis. call collect: 1-414-542-6060

A GREAT CHRISTMAS GIFT!



The Ideal Gift for Any Elks Lodge Member Wood Framed Mirror



12" x 24"
with etched insignia
ATTRACTIVE USEFUL
in office, home or den
\$16.50 postpaid
14 days delivery

Concept Sales, Inc.
P.O. Box 454
Bristol, IN 46507

I am enclosing \$16.50 for each mirror.

Name _____
Address _____
City _____ State _____ Zip _____
(Indiana residents add 4% sales tax)
___ check ___ money order ___ Visa
___ MasterCard
Credit Card No. _____ Expires _____

NEVER BUY GAS AGAIN!

ELECTRIFY YOUR BIKE!



PEDALPOWER exciting new electric bike motor tames tough hills. Be independent. Shop when you want. Fits all Bikes. Adult Trikes. Installs in minutes. Thousands sold. Recharges overnight. Travels 100 miles for a dime. Easy payment plan available. Call or send for **FREE** illustrated booklet and Special Christmas OFFER.

CALL FREE
800-257-7955
MONEY BACK GUARANTEE.
FREE ILLUSTRATED BOOKLET.
GENERAL ENGINES CO.

5533 Mantua Blvd., Sewell, N.J. 08080.
*In N.J., Alaska, or HI. Call Collect: (609) 468-0270

\$300 a Week ... Now I'm a
FULL TIME LOCKSMITH

"Because of a disability, I needed work that didn't require much physical effort. I investigated Belsaw, and now I'm working full time earning as much as \$300 in a week."

Tom Tipton - Covington, Georgia

Make up to \$10 an Hour - Even While Learning! Send for facts! Don't let age, education or a handicap stand in your way. Be your own boss in a business of your own. Learn at home in spare time. All equipment and supplies furnished. Special tools, picks and a pro Key Machine are yours to keep. Send for facts. Accredited Member NHSC.

No Obligation... No Salesman Will Call

FREE BOOK BELSAW INSTITUTE
130V Field Bldg., Kansas City, Mo. 64111
Please rush **FREE** Book "Keys to your Future."

NAME _____
ADDRESS _____
CITY-STATE-ZIP _____

RUSH COUPON TODAY!

KEYS TO YOUR FUTURE gives full details!

3 OLD, OBSOLETE U.S. COINS



BARBER HALF DOLLAR
\$6.00 Minted from 1892 to 1915.

BARBER QUARTER
Minted from 1892 to 1916. \$3.50



BARBER DIME
Minted from 1892 to 1916. \$2.00

ALL 3 COINS \$11.50

Add 75c postage. Brochures with order. IMMEDIATE SHIPMENT. Allow time for delivery. Satisfaction guaranteed.

VILLAGE COIN SHOP
Dept E Plaistow, NH 03865

* HEARING AIDS *

From \$89.50—30 Day Trial
GIGANTIC SAVINGS ON BATTERIES

Write For Free Gift Offer
and Brochure Today

ELECTRONIC PRODUCTS
Box 2005-E, Pinellas Park, Florida 33565

JOKES FOR SPEAKERS!

Topical Joke-Bulletin with approx. 100 funny one-liners, stories and roast-lines. Created by top Hollywood comedy writers. Ideal for Business and Club meetings, Banquets, etc. Humorize your speech for any audience; any occasion. Current issue, \$5.95. Send check or m.o. to:

JOKES UN-LTD.
1357 Miller Dr. Dept. E-1, Hollywood, Calif. 90069

Elk of the Year

During the course of the year, many Brothers will receive praise and thanks for their service to Elkdom. The success of any program depends primarily upon an individual's effort and dedication to the order and confidence in his Exalted Ruler. One member of your lodge, however, will work harder and longer, will put forth the extra effort needed to assure success, and will work tirelessly until his assignment is concluded and successful. How can we recognize a Brother who gives so much to his lodge? Honor him as Elk of the Year. This program is designed to recognize the Brother who does not hold office and seeks no personal acclaim. He is willing to give of his time and talent to the lodge, and now the lodge has the opportunity to recognize his service.

Exalted Rulers should appoint committees to seek out and evaluate the services of individual members of their lodges. They should meet and openly discuss the contributions made by each of the applicants and arrive at a decision as to who shall be named Elk of the Year. Once the choice has been made, the recipient's name should be forwarded to our Grand Secretary, who will prepare the appropriate certificate. In addition, a special night should be planned to honor this Brother in the presence of his family and friends.

Please do not delay in the appointment of this committee, for I am certain you will encourage greater participation in lodge affairs by all members in the year ahead.

Peter T. Affatato, Member
GL Lodge Activities Committee

did you know.



get him." This pledge has never been broken.

Every year, the Elks of Indiana make a sizable contribution to Indiana and Purdue universities for cancer research. This is the major project of the Indiana Elks Association.

Past State President Thomas E. Burke of Lafayette, IN, has chaired this philanthropic project for many years. In some 30-plus years, Indiana Elks have contributed a total of \$1,969,250 to this project. It is their way of expressing concern in the battle to cure cancer.

You don't have to be an Elk to contribute to the Elks National Foundation. Many of the ladies have joined with their husbands in this charitable project. Some lodges have erected plaques listing the ladies of the lodge who are subscribers to the Foundation.

Elks often recall the bequest made by the "little old lady" from Tennessee during the year Edward W. McCabe was Grand Exalted Ruler.

For the first time in history, contributions to the Foundation exceeded \$2 million.

When it came to net membership gains last year, the state of Oregon was the leader with a net gain of 2,995.

Florida was next. Their net gain came to 2,776. Then came Colorado with 1,540, Oklahoma with 1,257 and Michigan with 1,252.

You, too, can help Build a Better Elkdom. Ask your Exalted Ruler or lodge secretary how you can receive a membership card seal.

Warren G. Harding, when he was president-elect, considered it his duty to attend the annual Elks Memorial Services. Always held on the first Sunday in December in Elks Lodges throughout the nation, the event on Dec. 5, 1920, at the Elks National Home in Bedford, VA, drew many prominent Elks. Harding was among them. He joined Marion, OH, Lodge No. 32 on March 13, 1900.

For the past 28 years, the delegates to the Grand Lodge sessions have voted to assess each Elk member \$1, in the event it is needed for national defense or a major disaster. This year in Dallas, TX, it was no different. At the urging of PGER William J. Jernick, delegates unanimously made it 29 years.

Fortunately, the assessment has never been imposed; but Elks stand ready to Build a Better America as well as a Better Elkdom. You're one of them.

Incidentally, November is Veterans Remembrance Month. Elks have vowed that "as long as there is a veteran in the hospitals, the Elks will never for-



BUCKSKIN TAN

WARM CORDUROY SLACKS

This year, Haband, the mail order slacks people from Paterson, N.J., are specializing in soft and handsome long-wearing Corduroy! BECAUSE IT IS WARM! And whether you wear them for heavy duty Outdoor Use or just to beat the chill of the new 65° Indoor Regulations, you won't find a nicer pair of gentleman's casual slacks!

- ★ Guaranteed Full Weight Corduroy*
- ★ Easy NO-IRON Permanent Press Wash & Wear!
- ★ Full Cut in Sizes up to Waist 54!
- ★ Finished Bottoms, ready to wear, exact to the inch!

Plus: Handsome, easy-entry diagonal pockets, deep No-Hole pocketing, "Talon®" zipper, Hookflex® top closure, and "Ban-Rol®" no-roll waistband!

LOOK AROUND! You won't find a better looking or more comfortable pair of cool weather casual slacks anywhere! And we will be proud to send you Two Pairs, in your exact size, direct to your home, AT NO RISK! (Read Guarantee.)

Millions of men send to Haband for all their menswear needs. You should too, and right now is a great time to get acquainted. Simply tell us your size and color choice and we will amaze you with this fabulous value and our fast reliable service.

* **Attention!** Don't be fooled by substitute or inferior quality Corduroy. These Haband slacks are full weight, full wale, lustrous quality corduroy. 100% NO-IRON Wash & Wear deluxe polyester and cotton. 100% made in U.S.A. At 2 pairs for \$24.95!

DON'T MISS OUT — Mail Coupon at Right:



NAVY

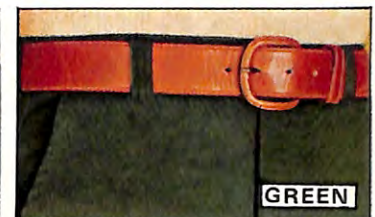

GREEN



BROWN

Haband's Polyester and Cotton
CORDUROY 2 pairs for only **24⁹⁵**
 Gentleman's Casual Slacks
 3 pairs for \$37.25

HABAND COMPANY
 265 N. 9th St., Paterson, NJ 07530

Sirs: Please send pairs of Permanent Press Corduroy Slacks, for which I enclose \$ plus \$1.25 toward shipping.....

GUARANTEE: Remittance refunded in full if on receipt you do not choose to wear the slacks.

72K-022

Name Apt. #
 Street
 City
 State ZIP CODE

FIND YOUR EXACT SIZE HERE:

Waist Sizes 29-30-31-32-33-34-35-36-37-38-39-40-41-42-43-44-46-48-50-52 & 54 (46 thru 54 add \$1 per pair)
 Inseams 26-27-28-29-30-31-32-33-34.

COLORS:	How Many	What Waist	What Inseam
Buckskin TAN			
Hickory BROWN			
Hunter GREEN			
Midnite NAVY			



HABAND

265 North 9th St., Paterson, NJ 07530

Where quality drinks begin.

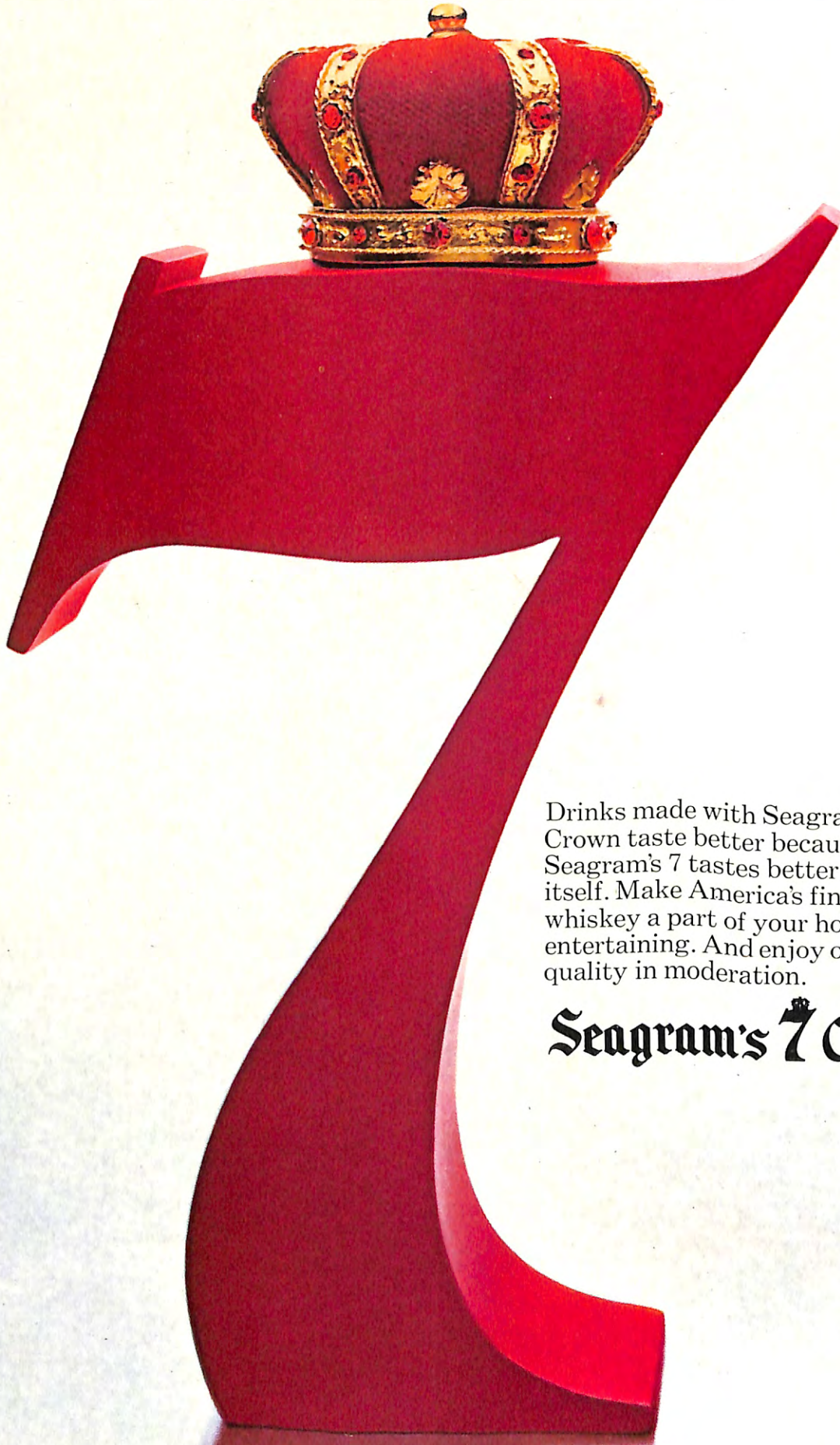

Drinks made with Seagram's 7 Crown taste better because Seagram's 7 tastes better all by itself. Make America's finest whiskey a part of your holiday entertaining. And enjoy our quality in moderation.

Seagram's 7 Crown