

the
Elks
magazine
October 1979

**Dallas
Convention
Highlights**



Discover
Arctic Lights
—more menthol refreshment than
any other low 'tar' cigarette.

Full menthol refreshment. That's what ARCTIC LIGHTS delivers.

A very special kind of menthol refreshment you just won't find in any other low 'tar' menthol cigarette.

You see, while the filter holds back 'tar,'

the unique new ARCTIC LIGHTS menthol blend comes right through. Result? You get the iciest, brightest taste in menthol smoking—puff after puff. Light up your first ARCTIC LIGHTS. **You just won't believe it's a low 'tar' menthol.**

Arctic Lights: Kings & 100's

© 1979 B&W T Co.

Warning: The Surgeon General Has Determined
That Cigarette Smoking Is Dangerous to Your Health.

9 mg. "tar", 0.8 mg. nicotine av. per cigarette by FTC method.

"Actively join with us who are concerned
about our country and our fellowman . . ."

HELP TO PROGRESS



A
MESSAGE
FROM THE
GRAND
EXALTED RULER

My Friends:

SHORTLY AFTER my announcement as a candidate for the office of Grand Exalted Ruler, ever so many friends came to me and wished me luck. I had a stock response to that: "I don't need luck, I need help." That statement was true before assuming this office, and it is true today. There is no way to lead this organization without the help you all can provide.

AS TRUE AS that is for me, so is it equally true for the Exalted Ruler of your lodge. If he asked for your help, would you willingly say Yes? I believe you would; unfortunately, in many instances the Exalted Ruler never has the opportunity to seek your assistance because you do not attend lodge meetings.

YOUR EXALTED RULER has a tough job. He must be a thinker, a tactician, a politician and above all, a respected leader. An offer of your help would provide an immeasurable boost to his morale, perhaps just when he needs it most.

YOU WOULD then actively join with us who are concerned about our country and our fellowman, and who feel as William Blake did:

*Can I see another's woe,
And not be in sorrow too?
Can I see another's grief
And not seek for kind relief?*

IT IS YOUR vigor and vitality which are necessary to **build a better Elkdom**. Without them we will struggle, but not always progress in a manner which increases your pride in your membership. With your assistance, there is nothing that is unattainable.

YOU DO NOT have to attend every meeting to be of help (certainly that is preferable, if possible); the offer to work on one committee in which you are interested will suffice to let the Exalted Ruler know you care about your membership.

JUST A LITTLE bit of help on your part will assure the continued growth, health and success of our efforts to make America a better place in which to live.

A handwritten signature in cursive script that reads "Robert Grafton".

Robert Grafton

Turn a part-time hobby
into big profits

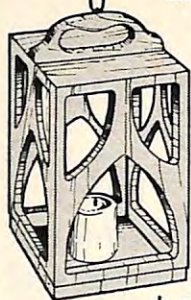

You'll pocket real profits making handsome coach lanterns like this ...and dozens of other popular wood gifts.

NOW! Earn up to \$15 an hour making popular custom wood products

Now, a Free Information Kit tells how you can make \$5, \$10, even \$15 an hour or more spare-time in your own basement or workshop.

A patented, easy-to-use woodworking tool – the famous Shopsmith Bryco Router Arm – lets even beginners quickly turn out a big volume of beautiful wood products and gifts that sell themselves on sight, at handsome profits.

You'll have fun making and selling deep-etched custom signs for home or business, beautiful picture frames, decorator wall plaques, coach lanterns, serving trays, trinket chests, and dozens of other popular, fast-selling items. You can even start a money-making furniture repair and restoration business if you like. It's the perfect way to turn an enjoyable and satisfying hobby into extra cash while being your own boss!

FREE BUSINESS-ASSISTANCE PLAN
Mail the no-obligation coupon below to receive, by mail, a Free Information Kit, "Your 'Rout' to Woodworking Profits," that tells you all about this profitable opportunity. We help you get started with a complete, thoroughly researched "Blueprint for Success" that includes advertising materials, project ideas and patterns, production aids... the "works". And, we'll help your business grow by sending you a constant flow of new project plans and business-building ideas.

Don't miss getting the free facts about this unusually good money-making opportunity! Mail the coupon today!

Mail to: Shopsmith Bryco Router Arm Div.
Shopsmith, Inc., Dept. 1957
750 Center Dr., Vandalia, OH 45377

FREE FACTS KIT

SHOPSMITH, Dept. 1957
750 Center Drive
Vandalia, Ohio 45377

Please mail me your Free Information Kit, "Your 'Rout' to Woodworking Profits" that tells how I can make money in my spare time with the patented Shopsmith Bryco Woodworking Router Arm – including the details of your complete "Business Plan". I understand there's no obligation, and no salesman will visit.

Name _____
Address _____
City _____
State _____ Zip _____

Cabinetmakers and professional
woodworkers inquiries welcome.

the ELKS magazine

VOL. 58, NO. 5 / OCTOBER, 1979

NATIONAL PUBLICATION OF THE BENEVOLENT AND PROTECTIVE ORDER OF ELKS OF THE UNITED STATES OF AMERICA. PUBLISHED UNDER THE DIRECTION OF THE GRAND LODGE BY THE NATIONAL MEMORIAL AND PUBLICATION COMMISSION.

THE ELKS NATIONAL MEMORIAL AND PUBLICATION COMMISSION

WADE H. KEPNER/Chairman
R. LEONARD BUSH/Vice-Chairman
RAYMOND C. DOBSON/Secretary
EDWARD W. McCABE/Treasurer
ROBERT E. BONEY/Asst. Secretary and Asst. Treasurer

JOHN R. RYAN/Publisher/General Manager
DONALD STAHL/Managing Editor
SUSAN ALBERT/Fraternal News Editor
SHIRLEY STERLING/Advertising Manager
MALCOLM B. CROFFORD/Circulation Manager
EDITORIAL OFFICES, 425 W. Diversey Parkway, Chicago, IL 60614

- 6 **The Horror of It All** Frank Thistle
A whole new generation has discovered movie terror and fallen in love with monsters, vampires and werewolves.
- 14 **Crucial Issues Face Businessmen in the '80s** John C. Behrens
Some observers predict that small business owners face a continued struggle for survival in the years to come.
- 22 **Convention Highlights, 1979**
The high points of the 1979 Grand Lodge sessions held in Dallas, Texas.

Departments

- | | |
|---|---|
| 1 Message | 32 Amendments to the Grand Lodge Statutes |
| 4 You and Retirement: Getting Along | 33 News of the Lodges |
| 8 Elks National Service Commission | 38 It's Your Business: Ingenuity |
| 10 Elks National Foundation/
Joy of Giving | 40 News of the State Associations |
| 12 Medicine and You: Dreampower | 44 Travel: Careyes, Mexico |
| 18 Major Projects: MA/TX/GA | 47 Grand Lodge Memorial Service |
| 20 Letters | 50 Elks Family Shopper |

ADVERTISING OFFICES



CHICAGO 60614 425 W. Diversey Parkway (312) 528-4500
NEW YORK 10017 50 East 42nd (212) 682-2810

THE ELKS MAGAZINE, Circulation Dept., 425 Diversey Parkway, Chicago, IL 60614

MEMBERS: Changes of address should be made through your lodge Secretary. Give him advance notice of at least 30 days. Remember that the day you write, your next copy is already in the mails. Before you move, file your new address at the post office to have mail forwarded. In writing to us regarding an address change, please give: Full name, lodge number, membership number, address to which copy is being mailed, and complete new address. Attach label from recent issue if available. Please show ZIP Code numbers in both old and new address.

THE ELKS MAGAZINE, Volume 58, No. 5, October, 1979 (ISSN 0013-6263). Published monthly at 425 W. Diversey Pkwy., Chicago, IL 60614 by the Benevolent and Protective Order of Elks of the United States of America. Second class postage paid at Chicago, IL, and at additional mailing office. Acceptance for mailing at special rate of postage provided for in Section 1103, Act of October 3, 1917, authorized May 20, 1922. Single copy price is 25 cents. Subscription price in the United States and its Possessions, for Elks, \$1.25 a year, for non-Elks, \$2.50 a year; for Canadian and Foreign postage, add \$1.50 a year. Subscriptions are payable in advance. Manuscripts must be typewritten and accompanied by sufficient postage for their return via first class mail. They will be handled with care but this magazine assumes no responsibility for their safety.

The word, Elks, is a registered trademark of The Benevolent and Protective Order of Elks of the United States of America. Copyright, 1979, by the Benevolent and Protective Order of Elks of the United States of America



**Just \$4,000 and 400 sq. ft.
adds this new money-making package
to your business.**

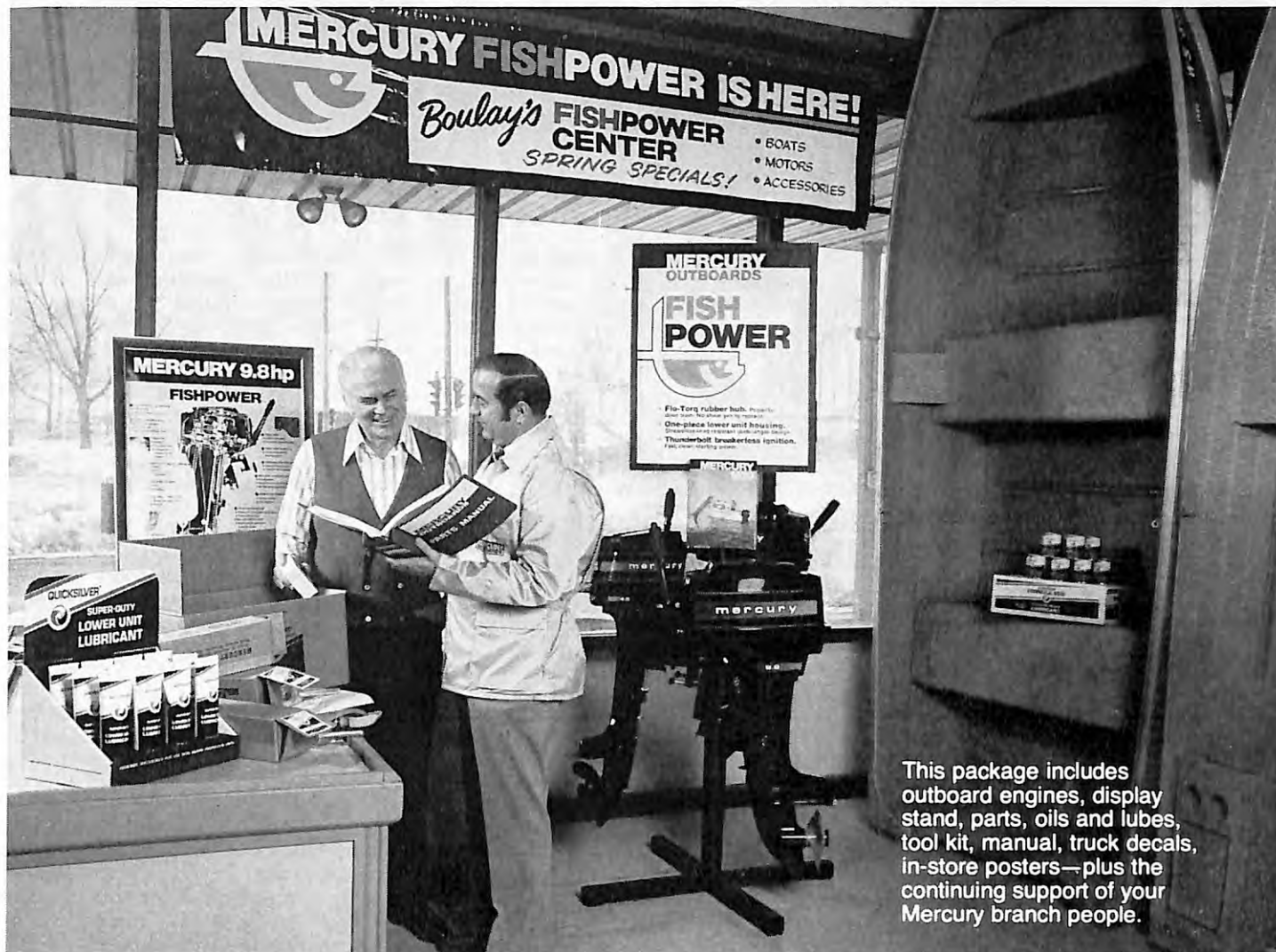

This package includes outboard engines, display stand, parts, oils and lubes, tool kit, manual, truck decals, in-store posters—plus the continuing support of your Mercury branch people.

THE MERCURY FISHPOWER PROFIT CENTER.

Here's a new business opportunity that can provide a significant return on your investment the first year. It's the new Mercury Fishpower™ Center—a total package that instantly puts you in the marine business.

You'll sell to America's biggest single sports and leisure time market—fishing enthusiasts. No, your location doesn't have to be near the water—65% of our dealers aren't.

You'll be selling the Mercury® line of small outboards, 4 to 20-horsepower, perhaps some small boats, and oils and lubes. As few as 5 outboards puts you in business. And we don't believe in selling the guy across the street. Remember, we invest in your success.

Mercury small outboards require only minimal maintenance and service. You need not add employees — we give your personnel all the service training needed. It is not mandatory that

you provide a full service operation.

Mercury has 40 years of experience in small outboards. In fact, small outboards make up more than half of our total engine sales. The typical boat and motor package, selling for \$1000-\$1500, has strong appeal for young first-time owners and seasoned fishermen. You'll be part of an exciting, growing market.

New profit opportunities like this don't come along every day. So if you'd like to tie in with a solid company and a world-famous brand name, you owe it to yourself to check this one out now.

Just call Dealer Communications Department, toll-free, 1-800-558-4898. In Wisconsin, call 1-414-921-8220.

**MERCURY
OUTBOARDS**

A BRUNSWICK COMPANY

Mercury Marine, Fond du Lac, Wisconsin/Canada/Australia/Belgium

a new inclined stairlift

For straight AND curved staircases

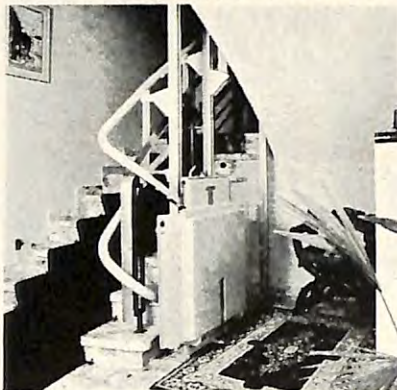
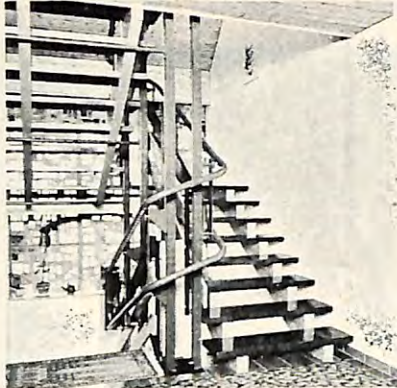

A Swiss invention now available in North America. Versatile — negotiates most straight and curved staircases.

Aesthetic. Quiet and failsafe electrical drive with manual back up. Platform and/or seat fold up to keep stairway free. Ascends up to three storeys with intermediate stops. Few or no building alterations needed. Costs a fraction of a conventional vertical elevator.

Ideal for colleges, schools, hospitals, churches and homes. For all people with stairway problems — carries you in a wheelchair or on a seat upstairs around corners. Helps with household effects and freight.



Garaventa are designers and builders of mountain aerial tramways and other cable systems.

Garaventa(Canada)Ltd.

7505 — 134A St., Surrey, B.C.,
Canada V3W 7B3
Phone (604) 594-0422

Surrey is near Vancouver in British Columbia

YOU AND RETIREMENT

by Grace W. Weinstein



GETTING ALONG

Retirement is a new stage of life, a welcome stage for most people. Yet, retirement—yours or your spouse's—may place unexpected strains on your marriage. The time to do something about those strains, if you can, is *before* retirement.

Your marriage may be stable. You and your spouse may get along very well. But you probably have spent relatively little time together during your working years. Togetherness based on evenings, weekends, and vacations is a far cry from togetherness 24 hours a day, 7 days a week. You may be looking forward to having lots more time to pursue mutual interests. But you may find, instead, despite the best of intentions, that you start to get on each other's nerves.

The solution? Plan ahead. Start with understanding. How much do you know about how your spouse actually spends the day? Do you assume that she will willingly drop her accustomed activities to spend the time with you? How much do you know about your partner's thoughts and feelings? Do you assume that she is looking forward to your retirement as much as you are? That she wants to live where you do? That she will welcome the change in circumstances? How much does your spouse know about you? Do you talk about these things? Or do you guess?

If you want to strengthen your relationship, start by assessing where you are. Do you:

- ✓ Like to do most things together?
- ✓ Prefer being alone?
- ✓ Make most spending decisions together?
- ✓ Argue about money?
- ✓ Find your spouse's habits irritating?
- ✓ Often interrupt each other?
- ✓ Finish each other's thoughts?
- ✓ Find certain topics hard to discuss?
- ✓ Appreciate your partner's sense of humor?
- ✓ Ever talk about anything but the house, the children and relatives?

If you analyze your own responses, and then compare them with your partner's, you may learn something new. Partners in longstanding marriages, no matter how basically loving, can become involved, tired, and uncommunicative over the years; many simply slide into a rut, take each other for granted, and become strangers. Sharing each other's thoughts and feelings—talking to each other, and

listening, really listening—may be worth the effort, because research studies have demonstrated that people with solid family relationships have happier retirements.

Solid family relationships are built on understanding. They are also built on plans for the use of time. What will you do in retirement? If you know that you'll be working part-time, or going to school, or avidly pursuing some long-deferred interest, you're in good shape. If you have some vague notions about spending the added time with your spouse, now is the time to make your plans more specific. Not that every minute must be organized—but total lack of structure and routine is uncomfortable for most people.

Resourceful retirees come up with individually-tailored plans. One couple volunteered, together, to work in the local hospital: he leads current events discussions among handicapped patients while she, on another floor, plays the piano for patient sing-alongs. They travel to the hospital together, but spend the day separately. Another couple spends most days in joint leisure activities, but once a week is "husband's day," his to plan and organize. Whether it's a day prowling flea markets or a day spent sorting old books in the attic, it's a break from the usual routine. Still another couple has breakfast out, together, each weekday morning, and spends afternoons pursuing separate interests.

If you're not sure what you want to do together, or where you want to do it, try some tested decision-making techniques. First, list all the possibilities in a given area before evaluating any one of them. Brainstorm: throw out ideas without regard to their merits, just to get as many ideas as possible on the table; you'll find that one idea leads to another and, often, to the best solution. Then, with all the ideas before you, make a list in order of your personal preferences; drop the ones you agree to drop, and discuss the rest.

You'll find a lot more about family relationships—including relationships with children and with older parents—in my new book, *Life Plans: Looking Forward to Retirement* (Holt, \$9.95 hardcover and \$4.95 paperback).

Note: Grace W. Weinstein has recently been elected president of the American Society of Journalists and Authors. ■

Raise as much money as you need!

**Sell a Pen-Pac for \$1
Keep 50¢ PROFIT!**

Make Big Profits for your school, church, team or civic organization. Here's the easiest fund-raising program around:

- Full 50% profit!
- Free step-by-step manual for fund raising leader!
- No call backs, no order taking no paperwork!
- Nothing to spoil!
- No heavy bulky packages to carry!
- No hidden costs — we even pay postage!
- NO RISK — Pay only after your fund raising drive is over AND return any leftover Pen-Pacs for full credit!

Pen-Pacs are a real value!

5 high quality ball-point pens with long-lasting ink supplies and effective ink erasers make up a Pen-Pac. Outside, its handsome blue & white design states, "Thank You for your generous help." It would sell for \$1.95 in any store. You sell a Pen-Pac for \$1.00 and keep 50¢ profit. Since everyone needs and uses pens, your funds really add up fast!

You Don't Risk a CENT!

There is no risk because you don't have to invest a penny. You have a full 60 days after you receive your Pen-Pacs before payment is due. That gives you plenty of time to complete your drive before you owe us a penny. And you can return any leftover Pen-Pacs at our expense. There are no hidden charges or extra costs. Ever.



Full 50% Profit

...and we ship free



Friends and neighbors will gladly buy

Everything You Need is Included!

25 Pen-Pacs come packaged in a lightweight carrying carton. Order 1 carton per member. Also included are contribution envelopes, a "how-to" manual, record-keeping forms, even press releases...all designed to guarantee your success.



**Call Toll Free
800-631-1068**

Monday through Saturday
from anywhere in the continental U.S.A.

In New Jersey call collect 201-227-7920
In Canada call 1-800-268-5534

CALL TODAY or MAIL THIS COUPON now!

There are 25 Pen Pacs to each carry carton. Order at least one carton per member.

We need to raise: \$100 \$200 \$300 \$500 \$ _____

Please send Pen Pacs 200 400 600 1000 We'll send the quantity you need.

Ship to:

Your name _____ Organization _____

Street address _____ Your title _____ (Age if under 21)

City _____ State _____ Zip _____

The above shipping address is a School Church Business Home Apartment

Area code () _____ Area code () _____

Home telephone number _____ Other telephone number where you can be reached, _____

Our drive will start _____ Number of members _____

Sign Here Before I order, please send more information.

U.S. PEN company
A subsidiary of Cadence Industries Corporation
Dept. FR645, W. Caldwell, N.J. 07006

All orders will be confirmed by telephone

Our 59th Year

2APP07
© 1979 U.S. Pen Company



THE
HORROR
OF IT ALL

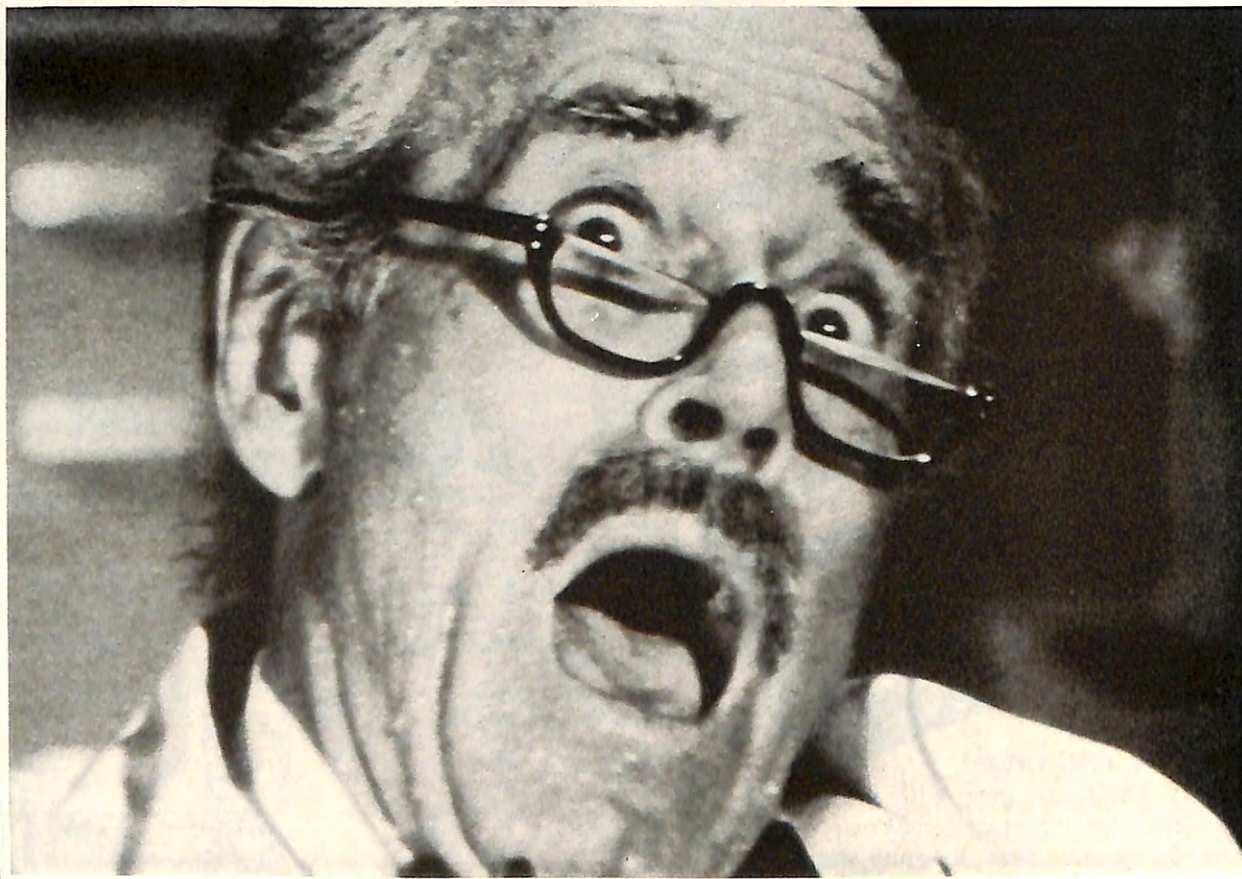

by Frank Thistle

The nation may have the jitters over economic problems, the gas and oil shortage, and the threat of a recession, but the Hollywood movie industry has a severe case of the "horrors." During the past several years the American public has been thrilled and chilled by all manner of horror pictures.

Recently, American International Pictures released a remake of the Dracula legend starring George Hamilton. To promote the picture, Hamilton toured the country, resplendent in cape and tuxedo, with his face as white as death. The show is called *Love at First Bite* and has comic overtones, but it's still scary. It has been a huge success.

About the same time, *Phantasm* was released. A real horror film, it runs riot with ghoulish images and delirious effects. It begins in a graveyard at night where the wind breathes ominously and a strange, growling noise comes from the dark. Hooded dwarfs rush out of the black and pounce on people. A small silver sphere zips through the white corridors of the mausoleum, seeking human flesh to sink its razor-sharp daggers into, scrambling brains and sucking blood.

Faster and faster come the bizarre horrors: a little buzzing people-eater, a



driverless car, red and yellow blood, a severed finger with a life of its own and, finally, the living dead. Each effect is more outlandish than the last, provoking first shocks, then laughs. Suspense is heightened by a cartload of old movie tricks: a hand that suddenly clasps a terrified person's shoulder and turns out to belong to a friend. The camera is kept tight on faces so that we're made to worry and wonder about what we can't see.

One good thing about *Phantasm* is that Don Coscarelli, the writer/director of the film, insists that we enjoy our fright. His attitude is that a scare movie should be run through a carnival fun house. He uses jokes, hurries from shock to shock and contrives his suspense so nakedly that the film totally disarms us.

Another horror movie with a completely different concept is *The China Syndrome*. When Columbia Pictures executives sat down last summer to plan marketing strategy for this new movie thriller, they thought they had a big problem: the public wouldn't know if *The China Syndrome* referred to Far East espionage, Oriental eroticism or perhaps some unspeakable disease. The movie moguls thought about changing the title to *Eyewitness* or *Power*—but decided to take a chance. Now, the nation knows all too well about the China syndrome, reactor meltdowns and life's chilling ability to imitate art even in the nuclear age.

The film, which opened to generally good reviews only 12 days before the Three Mile Island accident last April, is a rare phenomenon—a piece of popular entertainment that immediately foreshadows a major news event and

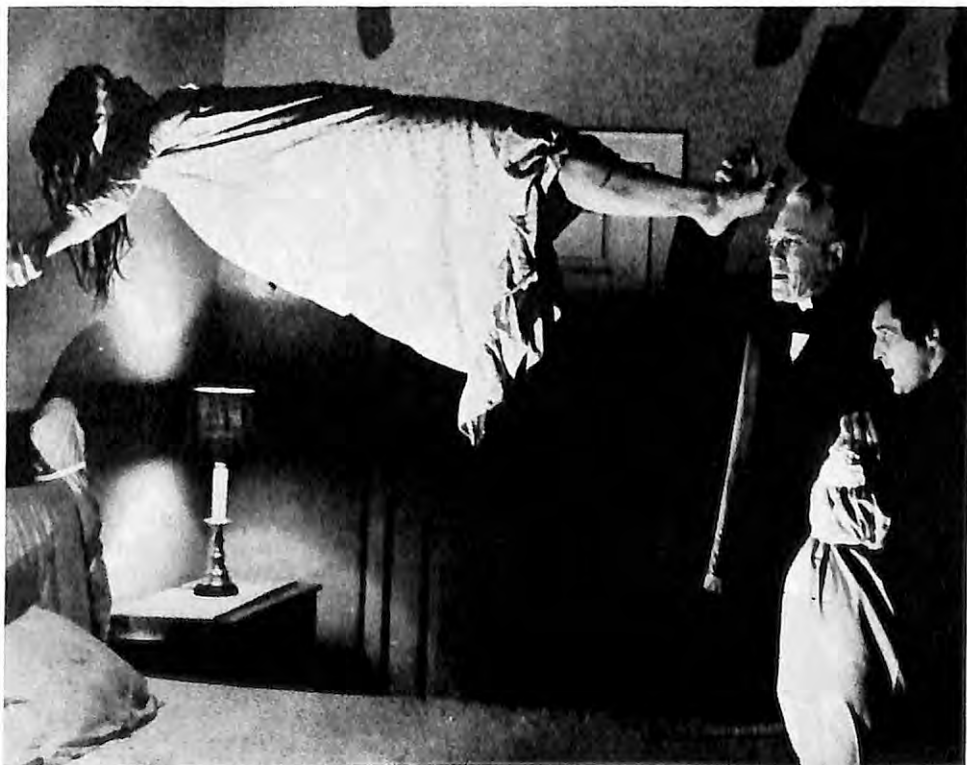

Henry Fonda in "The Swarm" (left) is attacked by killer bees; Linda Blair in "The Exorcist" (above) is possessed by the devil; and Lee Remick in "The Omen" (right) gets clawed by her monster child. On TV, Lou Ferrigno (top) growls as "The Incredible Hulk."

THE HORROR OF IT ALL

then helps explain it. But the film was a hit even before the accident. To charges that the film is unfair to the nuclear industry, Columbia executives can legitimately say that the real accident in Pennsylvania was far more serious than the fictional accident in the film.

Similarities between the film and the drama at Three Mile Island are striking. For example, the crisis in both began when a pump on the generating system shut down, followed by malfunctioning gauges and the possibility of a meltdown. In both cases, too, utility officials tried to minimize the danger. The most eerie coincidence comes when a nuclear critic in the film says that a meltdown in California could "render an area the size of Pennsylvania permanently uninhabitable."

It was *Jaws*, of course, that spawned a plethora of flicks spotlighting the viciousness of ants, spiders, octopi, wild dogs, alligators, whales and even killer bees. *The Swarm* was produced by Ir-

win Allen, who specializes in horror and disaster films. He brought us *The Poseidon Adventure* and *The Towering Inferno*.

Why does Hollywood have such a case of the horrors?

Says George Hamilton: "Historically, during times of war we have love stories and during depressions or times of economic problems we have science fiction, horror or comedy pictures. Well, we've just come through a war and we're on the brink of economic problems. If people have a choice of escape entertainment or being depressed, they will opt for escape."

Samuel Z. Arkoff, head of American International Pictures, leader in the horror film field, says: "Horror films do so well because none of it is real. It's a danger, a remote danger, one can enjoy. The whole area has been popular as far back as children's stories. Look at the wolf in Little Red Riding Hood. Many of the Disney things had an element of horror to them."

A Hollywood producer once ascribed his financial success to this credo: "Give the public what they want and they'll come." Producers long ago discovered that the public loves to be scared to death—almost. Horror pictures appeal to young and old. They all sit together, just about paralyzed during

the creepier sequences, and shriek in mock terror.

Horror movies are not new on the Hollywood scene. Twenty years ago, a young film producer named Herman Cohen stated that the mass market for movies was in the 12-to-26-year bracket and films should be aimed at that group. He based his theory partially on the fact that all the movies he produced in that vein had been successful. The only one that bombed had a more adult theme of fixing a basketball team.

Cohen was best known for spawning the "I Was a Teenage This or That" idea, with his *I Was a Teenage Werewolf* grossing \$2,000,000 with only a \$150,000 budget. His other efforts were in a like vein, nearly all on a low budget.

Said Cohen at the time: "You'll notice that although I make horror pictures, they are 'clean' pictures with no problems, no delinquents, no hot rodgers or undesirable aspects. All the horror is supernatural and no overly imaginative youth can identify himself with any of the characters and get himself in trouble."

The late Boris Karloff always claimed that chiller films can't harm kids.

"It's complete nonsense that the monster pictures (he disliked calling them
(Continued on page 31)

ELKS NATIONAL SERVICE COMMISSION

"So long as there is a disabled veteran in our hospitals, the Benevolent and Protective Order of Elks will never forget him."



Veterans were honored guests at a dinner held at Point Pleasant, NJ, Lodge recently. On hand for the evening's event were (standing, from left) ER Charles Capone, District Chm. and PER Donald Koch, and Lodge Chm. Ray Smalling. Point Pleasant Brothers joined in welcoming the vets to their lodge, as they do every year for the annual occasion.

In recognition for volunteer service to the VA medical center in Tucson, AZ, awards were presented to Tucson Brothers. Robert Taylor (left), chief of volunteer services, presented the citations to (from left) Howard Barlow, lodge bulletin editor, Lloyd Simmons, Al Lorenc, Sid Westervelt, and John Berglund. Raul Gomez, volunteer service specialist, was on hand for the occasion.



New York's Northeast District held an Americanism parade in Glens Falls recently. The event raised nearly \$1,190 for contribution to the VA hospital in Albany. Claude Ferron (second from right), chief of the hospital's building management service, and William Dougrey (center), a hospital patient, thanked (from left) District Americanism Chm. Gerald Shook, Parade Chm. Herman North, and PDD Moses Sweetgall for the donation.



Retire to Florida.



The SEAGULL From \$42,490

Independence Village is sunshine. Warm Gulf waters and year-round recreation. Come see for yourself our beautiful, *affordable* model homes and experience the year-round vacation life that is Independence Village in beautiful Port Charlotte, Florida. Send today for our Free kit giving all the details.

from \$38,990.

- Includes sodded and landscaped 10,000 sq. ft. lot.
- Don't touch your savings. No cash down.* No closing costs.
- 5 different 2 or 3 bedroom plans to choose from.
- Low monthly payments lets you enjoy your Florida retirement.

No Cash Down*

*100% VA mortgages for qualified veterans. Low down payments for non veterans. Prices subject to change without notice.

Independence Village, Inc.
511 E. Coliseum Blvd., Port Charlotte, Fl. 33953 (813) 697-3434

Please send my FREE Independence Village Kit.
I am interested in a home with 2 bedrooms 3 bedrooms.

Name _____
Address _____
City _____ Zip _____ Phone _____
State _____

E-7



Planer Molder Saw

3 Power TOOLS in 1

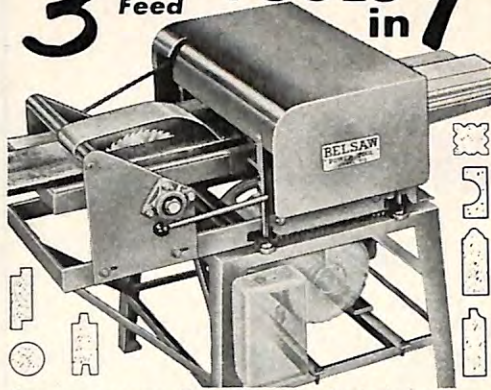

Now you can use this ONE power-feed shop to turn rough lumber into moldings, trim, flooring, furniture—ALL popular patterns. RIP-PLANE-MOLD . . . separately or all at once with a single motor. Low Cost . . . You can own this power tool for only \$50 down.

30-Day FREE Trial! SEND FOR EXCITING FACTS
NO OBLIGATION—NO SALESMAN WILL CALL
RUSH COUPON BELSAW POWER TOOLS CO.
TODAY! 9059 Field Bldg.
 Kansas City, Mo. 64111

BELSAW POWER TOOLS
 9059 Field Bldg., Kansas City, Mo. 64111

YES Please send me complete facts about PLANER—MOLDER—SAW and details about 30-day trial offer.

Name _____
 Address _____
 City _____
 State _____ Zip _____

GREAT ELK GIFTS

Elk styled gifts, all unconditionally guaranteed. Watch band & bolo tie available in silver or gold plate.
 Watch band \$21.95 Bolo tie \$14.95
 Price includes shipping and handling. Please allow 3 weeks delivery from order date. When ordering, specify gold or silver. BankAmericard Visa Master Charge
 Fill in card numbers and expiration date below. Date _____

Mail to J&L Ent., P.O. Box 486, Mt., CA 90640 (213) 724-6407

NEWMAN BRONZE MEMORIALS

Signs, honor rolls, Add-A-Plate tablets, hand tooled bronze, since 1882. WRITE FOR CATALOGS.

NEWMAN BROS. INC.
 5625 CENTER HILL AVENUE
 CINCINNATI, O. 45216

ELKS RITUAL CLOCKS

No initiation or lodge ceremony is truly complete without our Emblem Model (as shown) or a Custom Ritual Clock. A Portable Model suitable for funeral services is also available. Optional features may be selected. Over 40 years of satisfied customers.

11th HOUR MFG. CO.
 P.O. Box 3100
 Aurora, Ill. 60505
 312-851-7353

THE JOY OF GIVING

Elks National Foundation
 2750 Lakeview Avenue
 Chicago, Illinois 60614



Kevin Ambler of Palm Springs, CA, left, and Marcie Beck of Cottonwood (Murray), UT, were the first-place winners in the Most Valuable Student Contest. Both were present at the 115th session to offer their heartfelt thanks to the Elks.



Kevin and Marcie are shown with the Elks National Foundation Board of Trustees and their state sponsors. Seated, left, is PGER Horace R. Wisely, secretary of the trustees and co-sponsor of California; right, is PGER Robert E. Boney, sponsor of Utah. Standing, from the left, are PGERs John L. Walker, chairman of the trustees, Glenn L. Miller and Willis C. McDonald. Foundation trustees not present when the photograph was taken were PGERs William A. Wall, E. Gene Fournace and Robert A. Yothers.

SECOND PLACE AWARDS—\$2500 in each of four academic years.

Kenny Mac McCleary } Terre Haute, IN
 Lori Ann McAllister } Tied Awards Alma, MI
 Susan Marie Heidt } \$2250 each year. Dickinson, ND

THIRD PLACE AWARD—\$2000 in each of four academic years.

Timothy Albert Allwine } Shelby, OH
 (See tie above)

FOURTH PLACE AWARDS—\$1750 for one academic year.

Billy Coe Dyer } Mainland, TX
 Suzanne Marie Buchinsky } Shenandoah, PA

FIFTH PLACE AWARDS—\$1500 for one academic year.

Guillermo Davis Adame } Chula Vista, CA
 Cheryl Lynn Maggett } Paris, IL

YOU SAY YOU'RE FED UP WITH HAULING ICE?

Read about THE electronic breakthrough that has made the portable ice chest as obsolete as grandma's kitchen ice-box.

Does your family groan when it's time to empty all that yucky water out of the cooler? Are you getting tired of paying for food that goes bad? When somebody even mentions the word "ice" - do your back and shoulders ache a little?

YOU'VE COME TO THE RIGHT PAGE.

There's good news here: The Aerospace Program has spun off a portable refrigeration breakthrough!

Big Research Discovery

Space scientists at Cape Canaveral had to keep critical components in rockets and satellites cool. They needed something small and light...something that used very little power but was absolutely reliable...something that wouldn't konk out if it were tipped up, down, or sideways. The result? Solid state thermoelectric refrigeration modules that went to the Moon.

Enter Koolatron

Koolatron was quick to see the civilian-use possibilities of these modules for portable refrigeration. They worked until they developed Koolatron - a 12 volt portable electronic refrigerator that uses the same powerful solid state thermoelectric refrigeration modules used in rockets and satellites.

Saves Inconvenience

No more driving for miles or heading into shore for ice. Plug it in a lighter socket in your car, boat or van. Or run it off a 12 volt battery charger plugged into 110 volts.

Saves Energy

Koolatron uses very little juice - an average of only two amps when the temperature outside is 70 degrees Fahrenheit. That's less power than it takes to light a 30 watt bulb. Once contents are cold, you can turn it off at night to save power. Contents will stay cool for at least 6 to 12 hours. *Your* muscle energy is conserved, too. It weighs only 15 pounds - and you'll never have to haul ice again!



Model F1A shown.

The new Koolatron keeps 40 lbs. of food at household refrigeration temperature but weighs only 15 lbs. Only 21" x 16" x 16" ext.

Saves Shopping Trips

Koolatron holds more - so you spend less time shopping. Although it measures no larger than most ice chests, its 36 quart capacity is not half-filled with ice and sloshing water. So there's more room for food - 40 pounds of it, or 40 large cans of soda pop!

Saves Food

This is dry cooling we're talking about. Not the damp kind that breeds mold and can turn perfectly good food bad overnight - exposing the whole family to needless risk. Koolatron keeps your food cold and dry. With food prices so high, it's a shame to let any more meat and milk or sandwiches spoil!

Saves Money

Ice is expensive these days. So is the gasoline you use in looking for it. Don't waste another dollar this way! Get yourself a new Koolatron 12 volt portable electronic refrigerator and LET IT PAY FOR ITSELF. That's right. The money thrown away on ice and gasoline and spoiled food - not to mention what your own time is worth - will MORE THAN PAY for your new Koolatron in a single year!

Proof: A recent survey of Koolatron owners revealed their average saving was \$156.03

in just nine months. Some claimed they had saved over \$500.00 on ice, gasoline, spoiled foods, and the restaurant meals made necessary when the ice ran out.

No Toy

Koolatron is built to last. The rugged case is filled with the best insulation available - rigid urethane foam. Its heavy-duty handle can take loads of 150 pounds or more. Hinges and latches are made of non-rusting polypropylene. The exterior is a handsome harvest gold with a white, easy-to-keep-clean interior. Four non-slip rubber feet keep it from marring boat or camper surfaces.

No Hassle - Ever

Koolatron was designed by engineers who are also boatowners and campers. They know you want something simple that doesn't break down and is easy to service. Because of Koolatron's solid state construction your unit should never require any servicing unless physically damaged.

If service is ever required, it is available through our service depots in Batavia, NY, or Barrie, Ont., Canada.

So Reliable It's Guaranteed For One Full Year

Your new Koolatron comes with a written one year guarantee plus complete instructions and helpful information. If you need additional help or advice anytime, you can call or write for a personal reply.

21 Day Money-Back Trial Period

Use your Koolatron for 21 days after you receive it. If for any reason you are not totally satisfied, return it for a prompt refund in full.

Buy now at our new low price

Good news. Our increased sales have overcome mounting material costs. So for now we can pass on a saving of \$10.00 per unit. Formerly \$169.00. Now \$159.00 + \$7.00 handling and shipping (\$179.00 in Canada).

Adjustable Thermostat Option

For an additional \$10 you can order the Koolatron with an adjustable thermostat in place of the standard fixed temperature thermostat - order model F1A.

Phone your order in collect now to (705) 737-0842

Or use this handy order coupon.



SOUND FAMILIAR? ... "Mary, where do you want this 50 pounds of ice?" ... "Wait George, I'm not through draining the ice chest!" ... "Dad-dy you're dripping more water where I've mopped the floor!" ... "Hey, Mom, these tuna salad sandwiches are soaking wet and (pew!) they smell bad." ... "Mary, quick, I'm going to drop this @#%\$& ice on my toes!" ... "George - !"

Koolatron
INDUSTRIES
LIMITED

Dept. 812

56 Harvester Avenue, Batavia, New York 14020
Canada: 230 Bayview Drive, Barrie, Ontario
L4N 4Y8

Send me - Koolatron F1 @ \$159 (\$179 in Canada) + \$7 each for handling and delivery in USA or Canada (N.Y., Quebec and Ontario residents add sales tax).
-I want model F1A and have added \$10.
I understand that if I am not satisfied, I may return it undamaged within 21 days and get a full refund.

I enclose my check money order for \$ _____
or please charge my Visa Master Charge
 American Express

Acct. No. _____ Expiry date _____

Please send colour brochure only.

Signature _____
(necessary to ship merchandise)

Name _____

Address _____

City _____

State/Prov. _____ Zip/Postal Code _____

MEDICINE AND YOU

by Larry Holden



WAKING UP TO DREAMPOWER

The mushrooming scientific study of sleep—and especially dreams—may hold the key for every known mental disorder.

Through extensive clinical research, the outline of a modern dream theory seems to be coming into focus. Much simplified, the theory sees human beings as information processors. The brain apparently functions like a super-computer, and a computer must spend some time "off line" so that corrections, updating and new programs can be fed in. Likewise, the brain also needs a time when it sorts out and absorbs new data. Scientists now think it is dreaming that provides the mind with "off line" time.

"At night, we reconcile the new information to our old self and put it all together so we can get up and fight an-

other day," says psychologist Rosalind Cartwright of the University of Illinois.

Sleep restores fatigued bodies; but if that were the only reason for sleep, we would sleep much less, as the part of sleep that takes care of physical restoration is short. People who are in bed all day sleep as much as anyone, suggesting that sleep is needed not just for physical exertion. Slow-wave sleep, which restores fatigued bodies, remains constant in most people. It is dreaming sleep, which deals with learning and emotion, that varies.

Every night, for brief durations, the illogical, emotional, highly visual right side of the brain is almost freed from the dominance of the rational left side. The result is the torrent of images, sounds and feelings known as dreaming.

The study of sleep is spreading dramatically throughout the scientific community. "Studying sleep allows us to understand how the body and mind work together away from outside influences, and how the mind may create. And the internal generators of the mind are undoubtedly related to every existing mental disorder," explains Dr. John Herman, assistant professor of psychiatry at the University of Texas Health Science Center.

The fascination of dreams is certainly not new. Socrates looked on dreams as representatives of the voice of conscience. Voltaire dismissed them as random products of physical indispositions. Freud called them "the royal road to the unconscious." Lincoln viewed them as flashes from God.

Sleep is a time of intense physiological and mental activity. The kind of gentle oblivion we associate with "a quiet slumber" hardly exists. In fact, dreaming may be the chief reason for sleep.

Dr. Ernest Hartman, director of the Boston State Hospital sleep and dreams laboratory and author of *The Functions of Sleep*, feels that "the amount of sleep people need is determined by how much dreaming they require. Practical persons like Thomas Edison or Winston Churchill needed little sleep, but deep thinkers like Albert Einstein slept as much as 12 hours a night."

Each night during sleep, there are bursts of activity in the body that cause the eyes to dart to and fro, the inner ears to twitch and the heart to speed up. These periods emerge when specific lower portions of the brain turn on and issue pulses of electrical energy. This active state gets its name from the eye activity that occurs—rapid eye movement (REM) sleep.

One sleep disorder is narcolepsy, in which the patient has sudden "sleep attacks" and persistent sleepiness during waking activity. This neurological problem affects more than 80,000 people in the United States. The premature triggering of the REM sleep mechanism, which causes the "narcoleptic naps" during the day, also causes the patient to go immediately into REM sleep at night without first going into the normal non-REM sleep. Following this, the patient awakens frequently, paradoxically suffering from insomnia.

A condition known as sleep apnea is often confused with narcolepsy because of excessive daytime sleepiness. But it can be distinguished from narcolepsy by heavy snoring, the apnea "trademark." Many of these patients are obese and suffer from high blood pressure. These patients literally stop breathing many times during the night's sleep, each time momentarily arousing to the point that breathing is possible. They are unaware of the breathing difficulty at night; rather, they seek help for excessive daytime sleepiness.

Nocturnal myoclonus and the often related "restless legs" syndrome are forms of insomnia in which the twitching of the legs awakens the patient. Sleepwalking and bedwetting are other common sleep disorders. Even "jet lag" involves a disruption of the sleep-wake cycle. ■

Does our quality accounting service account for our growth?

More than 16,000 monthly business clients say "Yes!"

And each of our professional accountants provides the monthly services of a full-time accountant at a surprisingly low cost.

But there's much more.

Our clients benefit from the most modern, computerized accounting service around. No skimping. Complete bookkeeping, accounting and tax services. Here's what you'll receive every month:

- Operating statement for current month and year-to-date, with percentages for both
- Balance sheet as needed
- Bank reconciliation
- All tax returns
- Employee payroll records
- Regular consultation with your Comprehensive® accountant

For more information, contact S. Denton . . .

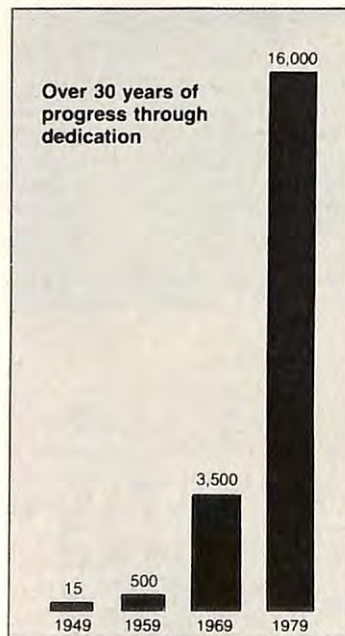

Call toll free (800) 323-9000
In Illinois, call collect (312) 898-6868

COMPREHENSIVE®

business services

2111 Comprehensive Drive, Aurora, Illinois 60507

A Nationwide Network Of Independent Accountants Specializing in Small and Medium-Sized Businesses

The Official Tabulators for the National Easter Seal Telethon

Crucial Issues Face Businessmen In The '80s

Some observers predict that small business owners face a continued struggle for survival in the years to come.

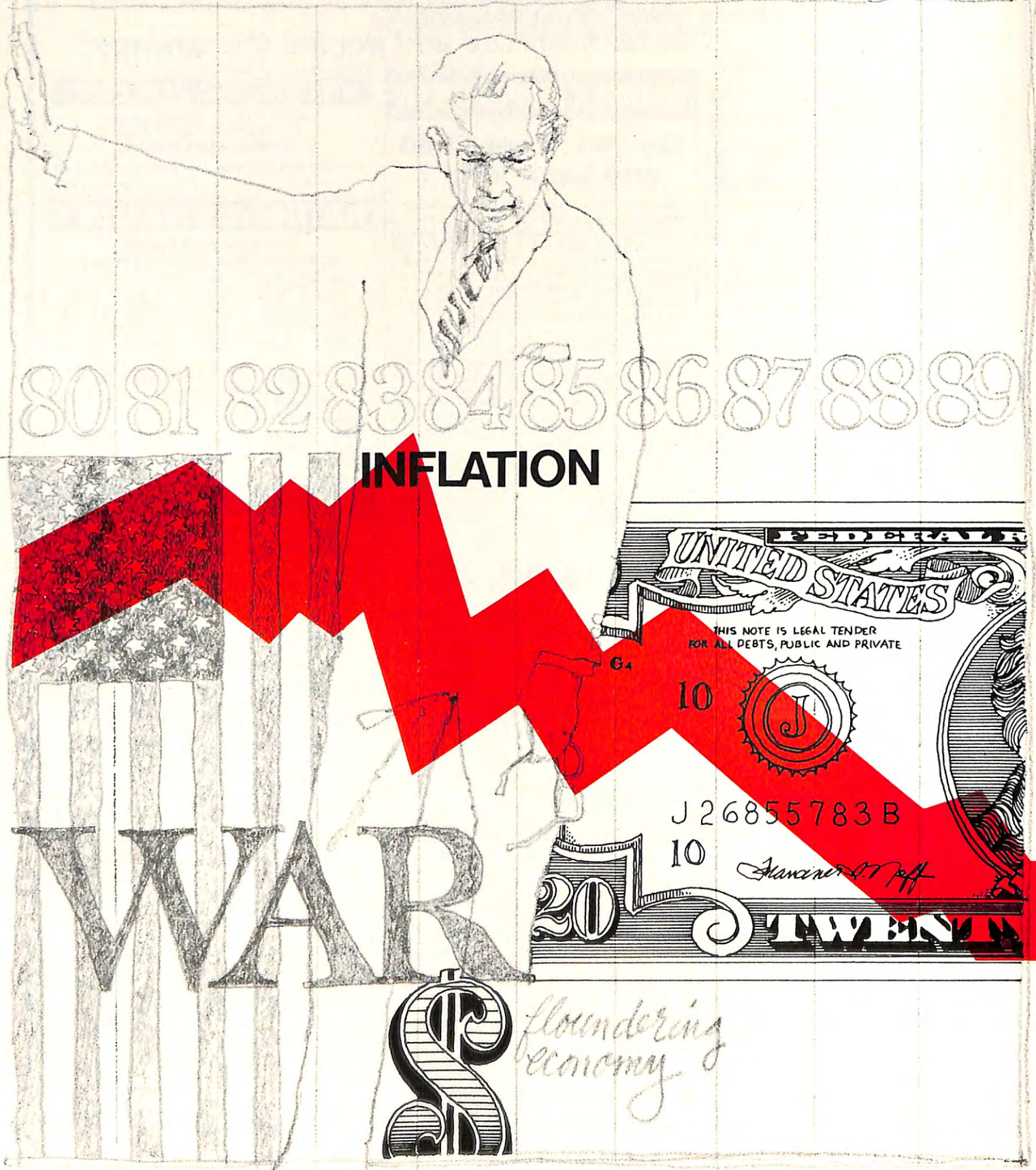

The gathering of professional and business men at lunchtime in the spacious upstairs meeting room of the Point Brittany, Florida, Men's Roundtable every Thursday is as American as apple pie and the Pledge of Allegiance which starts every program.

But the conversation these days has changed. The weather still gets major attention, of course, but most other matters are frequently shoved aside as worried people talk about filling station closing hours, the state of the nation and the economy.

The dialogue is somber at times. When these active and former community and industry leaders—transplanted from virtually every state in the union—get together, they echo each other's concerns about inflation, a floundering economy and the possibility that both could lead to war. "Those first two will break this country in time," warned one Roundtable regular not long ago. "They'll get us into war in the 1980s unless we find some answers," a friend chimed in. No one scoffed at his suggestion.

Such an exchange could probably take place anywhere today. Perhaps the gloom comes more naturally to those who have lived through a depression, two world wars and a number of partial military mobilizations. They remember the assurances that government leaders gave each time. This interruption in your life, they were told, is necessary so that your children will never face such difficulties. Some are bitter, a few feel betrayed. Others are resigned to face another decade apprehensively.

Yet there are optimists, too. An investment counselor in the northeast, for example, believes that the 1980s

can bring more good news than bad. "I think we're going to have to live with a persistent inflation of about six percent...it will be higher than other periods of our history. However, I look for real economic growth, too. War would seem most remote. Unemployment probably will stay the same. But corporate profits will probably be strong," says economist Allyn Earl, who advises banks, concerns and their owners on the business climate.

Still others might feel more comfortable with the assessment of distinguished teacher, newspaper columnist and lecturer, Dr. Max Lerner. Though he laments the steady decline of the work ethic in America, Dr. Lerner has coined his own phrase to describe what he sees ahead. "I am a possibilist...neither pessimistic nor optimistic about America's future."

What are the crucial issues that face the American businessman in the 1980s?

"History always repeats itself. Sometime in the '80s I would look for a change in the direction of the pendulum," says James W. Lundy of the Small Industries Research Center at Pennsylvania State University. "There appear to be more discussions on the need for a sound economic growth without inflation, and investment by businesspeople. If there are sufficient changes in government regulations and in the fiscal and monetary policy of the government, we could see a real net growth in the private sector rather than large growth in the public sector. If the trend we are on does not reverse itself, then the country is certainly headed for economic difficulties."

The 1980s, Lundy continues, could provide real opportunities for innovation and growth of small business and services in electronics, among other specialties. "This would be for the consumer certainly, as well as the businessman. The applications of mini-computers and micro-processors for the average small manufacturing business and service business hasn't even started. The rapid growth and change in electronics technology in the last 10 to 20 years

has been fantastic. If these advances in technology continue taking place, there will be a lot of opportunity for small businesspeople. As growth occurs in this industry and costs come down, the applications can multiply. For people in business, electronics then can mean control, increased productivity and reduced costs."

Another popular field which could expand, depending upon the scope of government regulations and restrictions, is consumer testing and laboratory services, he noted. "It looks like there is going to be a lot of work done on toxicology and carcinogenic investigations of many types of products and chemicals. Any breakthroughs in the field of solar voltaic cells, energy cells, etc., could cause a revolution in our energy business."

Aside from the energy issue, which virtually everyone agrees is a number one priority in the '80s, many businessmen and economists think that an equally important question is whether the business community and the government can work out their difficulties. "The tendency today is for us to look to the government whenever we have a grievance. Of course, we then find the cure worse than the malady. Unfortunately, we never seem to learn our lesson," says Thomas Roden, president of Uniservice Risk Management, a member of the Utica National Group.

"We now have a government that takes, transfers and spends more than a third of the national output, and the percentage is rising every year. With government such a large factor in economic decision-making, we must ask ourselves how long we can retain efficiencies and quick corrections of a private enterprise system that operates

by John C. Behrens

"Now that we're over 50, do we have special insurance needs?"

Most likely you do. Lifestyles and income may change—so the insurance protection that was right for you years ago may not be right for you today. It may be time to take a second look.

Allstate invites you to send for a special free guide to insurance and other services for people over 50. It will show you a variety of ways that Allstate can help you protect your home... your car... your family and your future plans. It's all there in one fact-filled and informative booklet. Get your free copy today. Simply mail the coupon below.



Allstate[®]
You're in good hands

To get your free guide, please send this coupon to:
Allstate Direct Response Center
Dept. E-2
5616 N. Western Ave.
Chicago, IL 60659

Yes. I want to take a second look at my insurance needs. Please send me your free guide to insurance for people over 50.

NAME _____ AGE _____

ADDRESS _____

CITY _____ STATE _____ ZIP _____

TELEPHONE # (_____) _____
AREA CODE

Allstate Insurance Co. • Allstate Life Insurance Co. • Allstate Enterprises, Inc. • and Subsidiaries • Home Offices: Northbrook, IL 60062

Enjoy the coolest, sweetest, cleanest smoking pipe you've ever tasted... or it costs you nothing! MAKE THIS 30-DAY FREE TRIAL

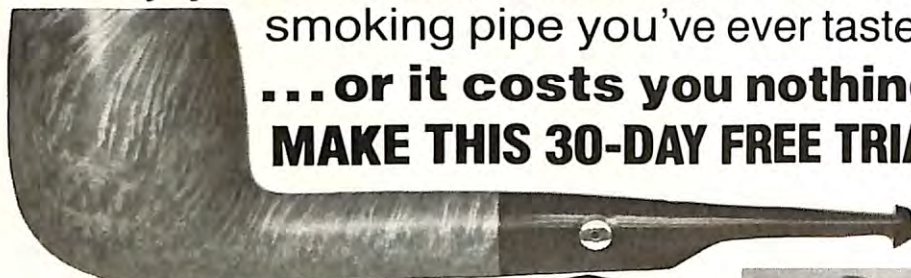

**NO FILTERS,
NO INSERTS**

**WITH THE
HIDDEN AIR VENT**

I'd like to be in your shoes right now! Then I could savor again the pleasure of smoking a Duncan Hill pipe for the very first time. What an experience! Its clean, cool, sweet, moisture-free smoke is unlike any other pipe you've ever had. No breaking-in. No bite. No bitter tar, nicotine or sludge. Just pure smoking enjoyment. All because of the Duncan Hill secret—the exclusive, tiny air vent, built into the biteproof "Duruvulk" stem. And it's the most comfortable pipe you've ever held in your mouth.



COOLS, DRIES, PURIFIES

The unique construction of the patented Duncan Hill air vent brings a measured amount of air into the stem with each puff. Hot smoke cools, bypassing tar, moisture, nicotine and bitter tasting "gunk" that are trapped in a scientifically designed condensation chamber. None of this reaches your mouth—just the rich, cooled flavor and aroma. No need for filters, inserts, constant cleaning.

HANDSOME, HAND FINISHED

The Duncan Hill Pipe is ruggedly handsome imported Algerian briar, finished and fitted by hand by a master craftsman in London. The flat bottom keeps ashes and coals from falling out when you set it down. It looks like the \$40 or \$50 pipes at fine tobacconists. But it costs far less, and their taste won't match it!

DUNCAN HILL, LTD. DEPT. 3K9
70 West Drive, Hartville, Ohio 44632

TRY IT FOR 30 DAYS WITHOUT RISKING A CENT

Once you smoke my pipe for 30 days, you'll never want to part with it. That's why I'm making this unusual offer. SEND NO MONEY! Mail the coupon. I'll send you a brochure. You select the pipe style you'd like to try. And I'll show you how you risk not one cent in this 30-day free trial. My offer, of course is limited. So be sure to get this coupon in the mail to me today.

DUNCAN HILL, LTD. Dept. 3K9
70 West Drive, Hartville, Ohio 44632

OK, Mr. Hill. I'll take you up on your offer. Mail the brochure so I can select the pipe style for my 30-day no-risk trial.

Name _____

Address _____

City/State/Zip _____

Crucial Issues Face Businessmen In The '80s

under the discipline of profit and loss," maintains Reginald Jones, chairman and chief executive officer of General Electric Co.

"I think the public is beginning to rebel against this accelerating drift toward a regimented society. There is a rising protest against inflation which will continue. There is disenchantment with big government and its endless interference in our lives."

In the long run, Jones continues, the spirit of enterprise will dissipate unless the current climate of bureaucratic involvement is checked. "A productive economy is really the sum of many productive activities by many people. But increasingly, the non-productive activities—the lawsuits, regulatory hearings, paperwork, battles with bureaucrats, projects started and abandoned, mandated expenditures on non-essentials—these non-productive activities, if they keep expanding, will finally overwhelm the productive activities."

Lundy and Jones are firmly convinced that the '80s will bring back American ingenuity and conviction if government takes a lower profile. "I don't think that this new decade will bring government domination and repression of business and labor unions unless we entirely change our form of government and go to some form of complete socialism or dictatorship," Lundy suggests.

"What people want in the '80s is moderation...some effort to balance the benefits against the costs...some respect for their personal judgment...some encouragement for producers and innovators...some relief from the ministrations of an overly helpful government and some respect for their liberties," Jones adds.

Will business need its own Howard Jarvis to accomplish such tasks?

Most business observers don't see one person or even a single organization shaping such policies. "I have been such a grass roots person and I realize that there is simply no effective way of marshalling small business opinion," says Prof. George Doyle of Assumption College. Prof. Doyle authored a definitive study for the Joint Economic Committee of Congress that sought to formulate a national policy to preserve private enterprise in the 1980s. "Businessmen do not have a common group to rally behind and they certainly can't count on the general electorate to be

sympathetic to their problems, because in many cases they are caused by consumerism."

Lundy disagrees. "The decade may bring business one or more Howard Jarvises. Even though businessmen are an independent lot, I believe they would provide the necessary support for rational leadership in solving some of their problems. The reason I believe there will be more Jarvises in the 1980s is that the politicians are simply not getting the message. The politicians and people in government are going to have to be told again, again and again that people want less interference by the government, less government, less taxation and less government spending."

Doyle doesn't believe that the trend toward bureaucratic interference has anything to do with a drift toward Marxism. "I view this as a return to the ancient mercantile state rather than a trend toward socialism."

Small business owners face a continued struggle for survival in the years to come, observers predict. "The lower rate of economic growth, together with the increasing demand for capital by both government and larger businesses, will make smaller business an endangered species," Doyle insists. Others contend that decreased profit margins caused by continued inflation and competition from giant conglomerates will persist.

Lundy maintains, however, that two problems of the past will confront proprietors again in the 1980s. "Historically, the small businessman's major problems have been poor management and a lack of sufficient working capital. Together, these problems will cause the small businessman to have difficulty in generating working capital to operate his business without going further into debt."

He doesn't expect that the trend toward acquisition by monopolies or threats of mergers will diminish the position of the small business owner. "Mergers, both friendly and hostile, usually occur among medium and large, publicly owned firms. The majority of small businesses in this country, whether incorporated or proprietorships, are private and closely held concerns. The threat of mergers or takeovers of small businesses is not a problem today nor will it be one in the future."

The Pennsylvania business specialist argues that the Carter Administration's efforts to continue wage and price controls when inflation is the problem "is like putting a Band-Aid on a man who needs a tourniquet. A common enemy of citizens, labor union members and businessmen is government deficit financing and the printing of too much

(Continued on page 43)

REMEMBER LAST WINTER?

Wherever the winters are cold, with temperatures in the "teens" and "wind-chill factors" even lower, people are talking about Damart Underwear.

And no wonder! Damart is the unique underwear that keeps you amazingly warm, dry and comfortable no matter how cold it gets, no matter how hard the wind blows. No matter how long you stay out! You'll have to run your fingers over Damart Thermolactyl to discover how soft it is! You'll be thrilled at Damart's light weight that lets you move so easily.

Damart does this with a new miracle fabric—Thermolactyl. It's knitted to let *perspiration out!* No other underwear does this! You can wear Damart indoors too, and turn your thermostat into the 60's. You'll feel perfectly comfortable and enjoy dramatic savings in home heating costs.

Damart will be supplying *The 1980 U.S. Winter Olympic Team* with Thermolactyl underwear! Damart is so comfortable that the Mt. Everest climbing expedition wears it. So does the Chicago Bears Football Club, New England Patriots and Philadelphia Eagles.

Our free catalog tells the full Damart Thermolactyl story and displays the whole Damart line for men and women, *including tall sizes*. Send for your **FREE** copy now!



SUPPLIER 1980 U.S.
WINTER OLYMPIC TEAM

THE PROOF IS IN THE WEARING

Damart Thermawear, Inc.
WHEN IN THE BOSTON AREA, VISIT OUR
PORTSMOUTH, N.H. STORE. (603) 431-4700



THERE IS NO WARMER UNDERWEAR MADE!

Fill out and send to:
DAMART, INC. Dept. 10699
1811 Woodbury Ave.
Portsmouth, N.H. 03805

YES! Rush me your **FREE DAMART** Catalog . . . I want to enjoy the fantastic warmth of Thermolactyl Underwear, a DAMART® exclusive. (I understand there is no obligation.)

PRINT NAME _____

ADDRESS _____

CITY _____

STATE _____

ZIP _____

© 1979, Damart, Inc.

MAJOR PROJECTS

This is the concluding section of the series on the state major projects. The editors of The Elks Magazine thank all those who have sent the information necessary for the articles. We hope they have been a source of interest and enjoyment for our readers.

For more than 40 years, the **Georgia** Elks have been actively involved in providing service to children in need. For 36 years, the state major project provided medical care for handicapped children through the Elks Aidmore Hospital in Atlanta; but in 1976, the Elks Aidmore Hospital closed.

In their search for a new major project, the Georgia Elks found the Plantation Manor Children's Home in Conyers. The Home was the property of the Frances Wood Wilson Foundation, which intended to close the Home in order to devote time and money to other charitable projects. When the Georgia Elks expressed interest in continuing the Home, the Wilson Foundation gave the property to the Elks. In November of 1977, the Elks Aidmore Children's Home officially opened.

The Home benefits children who face the brutal reality of parents who cannot or will not keep them. Many of these children are victims of parental alcoholism, abuse, neglect, rejection, or abandonment. Children with parents in prison or with parents experiencing a severe marital or financial crisis are also welcomed at the Home. The project is not designed to help delinquent children or those with severe mental or emotional problems, but rather is a place for children whom Executive Director A. E. Koch refers to as "orphans of alcoholism, abandonment, and mental illness."

Youngsters can be referred to the Elks Aidmore Children's Home by families, juvenile courts, or public or private social agencies. Children are accepted from any part of the state, and range in age from six to eighteen years old.

Executive Director A. E. Koch brought to his new position many years of experience as executive director of the Elks Aidmore Children's Hospital. He chose to emphasize a family atmosphere at the Children's Home. "It's hard to imagine a kid going through the experience of having his home fall apart without emerging with some scars," he contends; children need "a home, stability, and structure. They need a mom and a dad."

To carry out his convictions, Mr. Koch expanded the cottage program in which ten children live with three group care workers in each cottage. The cottages are self-contained living units in which a family style of living is encouraged. Nearly every youngster has his or her own room, which allows for a great degree of privacy and individuality.

The four cottages can accommodate 40 children. Thirteen other buildings are included on the 113-acre wooded estate, located in suburban Atlanta. The woods

and the open land, which includes a fishing pond, are an additional benefit.

The goal of the Aidmore program, however, is not to keep the children, but to return them to a secure family life in a community. While the children are residents of the Aidmore Home, social workers actively involve parents and guardians in efforts to restore a normal family life to which the children can be safely returned.

While at the Home, the youngsters attend local public schools. Because of their past backgrounds, many of the children have fallen below the average scholastic level for their age. At the Home, they are helped to catch up by individual tutoring and by an intensive, eight-week summer school session.

The children are also encouraged to participate in the work program, in which they carry out cleaning and maintenance work on the buildings and grounds and are paid small salaries. Recreation is not restricted to roaming the woods and fishing in the pond; the buildings house a gymnasium and a swimming pool, and the grounds include a baseball field and tennis courts.

The Georgia major project is governed by a board of trustees, which includes representatives from each lodge in the state and five members of the Elks Aidmore Auxiliary. The Home has an annual operating budget of \$316,000. The funds are provided by the lodges and the Elks' ladies and by dividends from the Elks Aidmore Trust Fund and other investments.

The concern of the Georgia Elks for the youth of our nation has been carried over from their previous major project. They continue to concentrate on those children who need their help: children who face life without the emotional and psychological advantages which ordinary family life can provide.

The first step towards recovery from an illness or compensation for a handicap is to determine the nature of the problem. To do so can involve a long process of testing and observation. The **Texas** Elks Foundation for Handicapped Children is a center for the evaluation, diagnosis, and prescriptive management for medically, educationally, and psychologically handicapped youngsters. It serves the child, parent, and school without charge and without regard for race, religion, or ethnic origin.

Before 1977, the Texas major project was the support of the Texas Elks Crippled Children's Hospital, which, since 1946, had served as a rehabilitation center for polio victims of the late forties and

early fifties. With the abatement of polio as a major debilitating disease among children, the hospital's board of directors looked for a new focus of concern. In August of 1977, the hospital became a diagnostic and evaluation center of multiply handicapped children.

A potential client may have a vision, hearing, orthopedic, or neurological impairment, may be mentally or developmentally retarded, or may have a learning disability or emotional disturbance. When a child is accepted into the program, he or she is admitted to the facility for a six- to eight-week residential evaluation period. While at the hospital, the child enters a diagnostic classroom and undergoes both educational and psychological tests and observation.

Upon completion of the diagnostic program, the staff of the center assists the family in securing a school placement and other services or, if necessary, a residential placement. Parents may also receive counseling and guidance in understanding their handicapped child. The center's staff will provide suggestions for assisting and teaching the child in a daily living situation. They will also help teachers form a meaningful educational program for each individual, and prescriptive and diagnostic materials are available.

Approximately 200 children have been clients of the center, and 75 percent have returned to local community life. The staff behind this success is composed of an administrator, two educational diagnosticians, a certified teacher, a psychologist, a social worker, registered and vocational nurses, child care personnel, and office and maintenance workers. The center is governed by a board of directors which consists of one representative from each of the state association's ten districts.

Financial support of the major project comes primarily through a quota assigned to Texas lodges, various contributions, and the income from investments in the Endowment Fund, which is administered by the board of directors. Contributions may be made either to the Operating Fund or to the Endowment Fund.

Certificates are awarded in order to recognize those who help Texas Elks in their endeavor to assist the handicapped. Such recognition is important, as is the major project itself. Rehabilitation requires successful therapy and treatment, and proper therapy follows evaluation and diagnosis. Texas's major project has provided a service which helps to ensure the success of this process.

From New York to California and Washington to Florida, the Brothers of our nation have launched fund-raising programs to support their major projects. Through their efforts to aid and maintain charitable programs, Elks have discovered a variety of ways to raise money. **Massachusetts** Brothers have created a rather unusual program which successfully collects funds to support one part of their major project: a scholarship fund.

Over ten years ago, PSP Arthur Kochakian, a member of the GL State Associations Committee, pursued the idea of
(Continued on page 64)

If you've never read music before –
now you can . . .

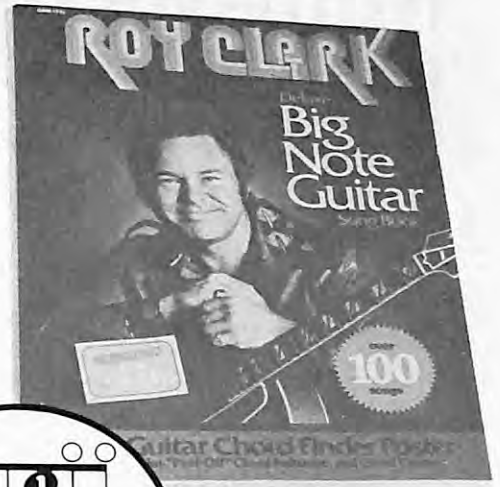
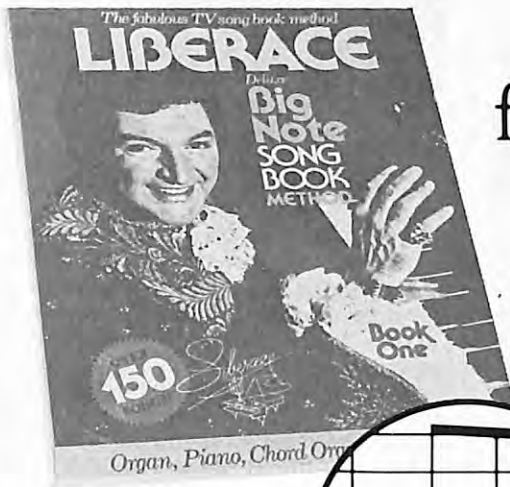

play your
favorite tunes
instantly –
the first time
you open
these

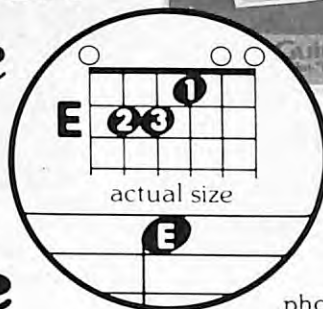
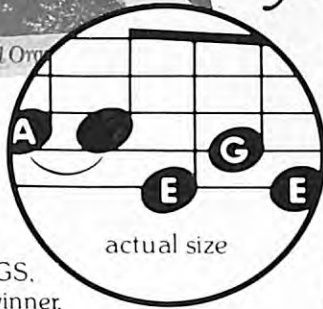

For **KEYBOARD**, or any instrument tuned to the key of C. **OVER 150 SONGS**, including Grammy Award winner, **YOU NEEDED ME**, recorded by Anne Murray and **HEARTBREAKER**, recorded by Dolly Parton. **POPULAR HITS: Feelings, I Write The Songs, SING ALONG FAVORITES, SACRED SONGS and POPULAR STANDARDS.**

Big Note Method Song Books

For **GUITAR** – words and music to over 100 songs. 224 pages of music plus photos and Roy Clark biography. **POPULAR HITS AND ALL-TIME FAVORITES.** Feelings • The Closer I Get To You • Blue Bayou • The Candy Man **PLUS SPECIAL ROY CLARK ARRANGEMENTS**, including Let Me Be The One. Play them all – as easy as 1–2–3.

LIBERACE by and ROY CLARK

The Liberace Deluxe Big Note Song Book features oversized, easy-to-see notes with the name of each note boldly indicated right on the note. No guesswork. No memorizing. Arrangements are lush and full-bodied, letting the music lover enjoy the richness of sound.



SPECIAL PRICE
\$9.95 each

Regular Price \$12.95 each

The Roy Clark Deluxe Big Note Guitar Song Book contains all words, music and fingering frames with oversized, easy-to-read notes. Names of notes, fingering numbers and strum marks are boldly indicated – plus full color Chord Finder Poster and number stickers for your guitar fingerboard.

“This is one of the greatest musical innovations of all time.”



“Use my special method, give a little strum, and HEY! YOU'RE MAKIN' MUSIC!”

Library No. GMB100

Library No. GMB112

Charles Hansen II • Music and Books of California, Inc.

NO RISK ORDER FORM

8439 3979

aka Hansen House

2030 S. Sepulveda Boulevard
West Los Angeles, CA 90025

PLEASE RUSH MY LIBERACE Deluxe Big Note Song Book (GMB100)

ROY CLARK Deluxe Big Note Guitar Song Book (GMB112)

Enclosed is my check or money order in the amount of \$9.95 each, plus \$1.00 for postage and handling. I understand that I may return this book for a complete refund within 30 days if I am not completely satisfied.

TOTAL AMOUNT ENCLOSED \$ _____ Illinois residents add sales tax

NAME _____

ADDRESS _____

CITY _____ STATE _____ ZIP _____



MASTER CHARGE



VISA

CARD NUMBER _____

EXPIRATION DATE _____

SIGNATURE _____

EL109

ALMOST FREE

Mini-Micro Cassette Recorder

- Professional performance model
- Solid state micro-electronics
- Mistake-proof, finger tip controls
- Accident-proof magnetic erase
- Less than 0.5% wow and flutter
- Takes 30-minute cassette—included
- Recording signal light
- Only 1 1/6 x 2 1/2 x 5 1/2" and 11 oz.
- Complete with batteries, tape, earphones, wrist strap, carrying case
- One-year warranty parts, 90-days labor

Only \$39⁹⁵



I Risk Everything — You Have No Risk At All!

There was no time for a group decision. No way to share the blame. The deal was absolutely incredible—but I had to say "yes" there and then.

I said, "Yes, but..." and stood my ground. "Subject to our usual quality-control tests."

Douglas Dunhill had just bought its first closeout. And you can have the kind of convenient, professional-quality micro-mini cassette recorder that usually sells for \$119.95 for just **\$39.95**.

We Have Something To Prove To You

Actually, I'd been looking for this kind of incredible, what-have-you-got-to-lose bargain for almost two years. I know that for every person who buys an item from one of our ads there must be a hundred others who like it, want it and won't buy it—reluctant to do business by mail with a company they don't know.

Well, this time the price is so low, the bargain so unusual, you can't get hurt in any way. Besides, you have our unconditional 21-day money back guarantee. And since we're one of the oldest as well as largest mail merchandisers, you know we'll still be here in just three weeks.

Your greatest assurance, though, is the reason behind this closeout offer. We want to prove what we mean by our slogan "affordable quality" and demonstrate our reliability. How could we ever sell you anything else, which is the whole purpose of this ad, if the tape recorder isn't as good a unit as those you can buy for two or three times the price?

Three Week, No-Risk Test

So, you have three weeks to test the professional quality and to satisfy yourself that a recorder that picks up a whisper and can be carried in your pocket is a really valuable asset.

Take it on the commuter train, in a plane, driving in your car. Keep it by your bed. (I take mine with me when I shave.) Use it so you won't forget your ideas, to record meetings, summarize conferences, get the details of a deal on tape before they get away from you, to keep a record of your travel expenses. Then,



if you want, return it to us in the carton it comes in (following the simple directions) for a full refund. You'll see that this return privilege is one reason more and more people are buying by mail today.

To order with any national credit card simply call the *toll free* number any time, any day or night of the week. If you prefer, send your check to Douglas Dunhill at the address below. Please include \$3.15 for shipping and handling. (Ill. residents include 5% sales tax.) It's the tape recorder you always thought you wanted at a price you never expected. Order now without risk or obligation. It's tax deductible when used for business.

CALL 800-621-5554

Illinois residents call 800-972-5858
(In operation 24 hours a day, 7 days a week)

Douglas Dunhill
INC. AFFORDABLE QUALITY

Dept. 60-1582
Ten Douglas Dunhill Drive, Oak Forest, IL 60452
© Douglas Dunhill Inc. 1979



• Several years ago, I served on the Los Angeles County Grand Jury; and among our many concerns and investigations was the subject of "High Speed Police Pursuits," (July, 1979). I was chairman of the Criminal Complaints Committee and had the responsibility of writing the report of the committee, as well as the conclusions of the entire Grand Jury.

They certainly would have been incensed at the numerous insinuations by Wayne T. Walker about the actions of the police, who are responsible for law and order. The most irritating is his repeated reference to "turning an adrenaline-pumping police officer loose in a two-ton cruiser to chase someone at high speeds."

Yes, we did agree on the many disastrous results of a high speed chase . . . but surely everyone would have to agree that the basic fault rested on the shoulders of the person who fled. In the great percentage of cases we investigated, the reasons for flight were excessive drinking, the influence or possession of narcotics, no driver's license, prior citations, criminal activities or teen-age larks.

Our Grand Jury was concerned about a major reduction in high speed pursuits—not by restricting the police in the performance of their duties, but by imposing a severe penalty on anyone fleeing from the police.

I would like to see a recommendation made to legislatures in all 50 states to make it a felony to flee from police. This threat would have an immediate effect as soon as it was publicized.

The great majority of Elks are in favor of stronger, not weaker, law enforcement and will support this change in our law. At least I hope so.

Paul E. Haines, PER, PDDGER & PSP
Pasadena, CA

• . . . I appreciate the attempt of G. R. von Kronenberger to inform our Brothers and the general public of the seriousness of Glaucoma (July, 1979); and in this regard, I think he did a good job. However, as an optometrist, I feel an injustice has been done to my profession . . . I was unable to find any mention of the contribution that optometry makes in the detection and diagnosis of glaucoma . . . I would make the same remarks relative to Larry Holden's column on Cataracts (July, 1979). I find it extremely unpalatable when my fraternal organization, directly or indirectly, endorses one profession while omitting another, even if done accidentally . . .

W. David Sullins, Jr., O.D.
Athens, TN

Letters must be signed and may be edited.
Address to: Letter Editor, *The Elks Magazine*,
425 West Diversey, Chicago, Illinois 60614.

How to launch your own business for under \$1,000 and make \$25,000-\$50,000 a year!

Management consultant David D. Seltz is one of the nation's foremost authorities on small businesses. He has written 12 books on the subject and more than 2,000 articles in such publications as *Nation's Business*, *Dun's Review*, *Business Management*, etc.

He has spent 14 months researching 18,292 small business opportunities to compile the first complete directory of the most profitable small businesses you can start in your spare time for under \$1,000 (many for under \$500).

He has published his findings in a book called, "*A Treasury of Business Opportunities*," published for anyone who's dreamt of owning a business.

In its fascinating pages, you'll learn...

- How Michael S. makes \$50,000 a year in a small community by providing a little-known, simple service needed by the graduating class of every high school and college. His student customers are easy sales and his work consists mainly of placing phone calls.

- How John H. runs a weekend business that uses other people's vacant land to rake in as much as \$10,000 profit per weekend. No equipment, no investment, no employees needed!

- How James P. charges \$2,000 for a simple service most businesses need, but few people are aware of. He has so much business, he doesn't even advertise.

- How Ronald P. earns \$100 per week on a \$200 investment supplying a service needed by most storefront merchants.

You'll learn about a unique new product that's selling like wildfire to religious people and gives you a 500% markup. You'll discover an easy-to-start business that nets about \$25,000 profit in the summer months alone. You'll be given the amazing inside story of a business that requires so little of anything, you could run it out of a phone booth. Yet it's quietly making better than \$50,000 a year for scores of men and women.

And this is just the beginning! You'll learn how to rake in enormous finder's fees for putting two types of common business clients in touch with each other. You'll discover why certain national manufacturers will pay you upwards of \$40,000 a year for making local contacts for them. You'll see how to start a business in which moonlighters work their tails off to earn you \$50,000 a year.

You'll learn where to haul away crates of what some businesses con-

sider "junk"—but which other businesses need desperately and will pay you as much as \$60,000 a year for. You'll discover a product that costs pennies to make, sells for \$5, and is wanted by thousands in just about every community. And you'll be shown how to start an exclusive kind of club which can bring you more than \$50,000 a year from people who'll feel privileged to pay you a hefty membership fee just for the right to belong!

You'll see how to sell a few sheets of paper for as much as \$2,000 to businesses all over your home town. . . . You'll read about the "dead flower" strategy that requires only one visit per customer per month yet gives back up to \$25,000 per year in return. . . . You'll discover how to get people all over your community gladly lend you their cars and then just as gladly pay you up to \$50,000 a year to perform one simple, nonmechanical act with those cars.

You'll read the remarkable story behind one little-known business that is not only depression-proof, but actually does fantastically well when the economy grows worse. Not only are the profits potentially enormous in this business, but there is this unexpected advantage: Simply by issuing your own business card as a dealer enables you at once to buy men's suits for \$22, metal tennis rackets for \$8, electric typewriters for \$85, and dozens of other items far below wholesale.

If you or your spouse like to "putter" around the kitchen, just turn to page 68 of this book and see how you can make that puttering yield you a spare-time income of \$25,000 a year.

And if that's not enough to get you started in your own little "goldmine" business, wait till you discover . . .

- The instant travel business that gives you up to 50% discounts when you wish to go on a trip.

- The simple idea that lets you run your own sweepstakes—with *someone else* putting up the prizes!

- The method for earning thousands of dollars on other people's inventions.

- 23 different ways your car or truck can help produce profits every day.

- The way to turn each of your handy-man friends into a spare-time income of \$25,000 a year for you.

- The technique for having your products displayed and sold in the finest homes in your area—with sales as high as \$500 per home. This one strategy alone may be worth 100 times the cost of the book—and it's all yours on page 217.

FOR TOLL FREE SERVICE CALL:
800/621-5199 (Ill. Res. 800/972-5858)
On VISA or Master Charge orders.

30-DAY NO-RISK GUARANTEE

The "*Treasury*" is so crammed full of ingenious, *proven* money-making ideas, that we feel certain you will find in it the key to make your dreams of financial independence come true. Send today for your 30-day trial copy of "*A Treasury of Business Opportunities*," by David D. Seltz. If, for any reason, you should be dissatisfied with the book, just return it and every penny of your money will be refunded immediately.

© 1979 Farnsworth Publishing Company, Inc., Rockville Centre, N.Y. 11570

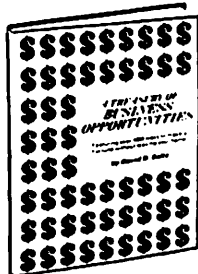

This oversize 8 1/2" x 11" format book uncovers dozens of little "goldmine" businesses. It gives you everything you need to get started in your own profitable business, in your spare time, with minimum capital.

FARNSWORTH PUBLISHING CO., INC.

78 Randall Avenue, P.O. Box 710
Rockville Centre, New York 11570

Please rush my copy of "*A Treasury of Business Opportunities*," by David D. Seltz, featuring the 154 most profitable businesses I can start in my spare time for under \$1,000. My money back in full if I'm not 100% delighted.

Enclosed is my check or money order for \$16.60 (\$15.00 + \$1.60 postage & handling). Or charge:
 VISA/BankAmericard or Master Charge:

Exp. Date _____ Sig: _____
Name _____
Company _____
Address _____
City/State/Zip _____

N.Y.S. residents please add applicable sales tax.

CONVENTION HIGHLIGHTS

Highlights of the 115th Grand Lodge Session Held in Dallas, Texas, July 1979



A total of 19 out of 21 living members of the Grand Lodge Advisory Committee (Past Grand Exalted Rulers) were present as the 115th Session of the Grand Lodge opened

in Dallas. They were introduced by PGER Francis M. Smith in the absence of PGER George I. Hall, honorary convention chairman, who was unable to attend due to his health.

Sunday Opening

"Big D" has become one of the favorite meeting places for Elks in recent years. The 115th Grand Lodge Session was held in the huge Dallas, Texas, Convention Center, July 15-19, 1979. It was the third time that Elks have gathered there in the past decade.

More than 17,000 members, their ladies and guests were in attendance.

PGER George I. Hall, honorary convention chairman, was absent due to illness. In his behalf, PGER Francis M. Smith, chairman of the advisory coun-

cil, introduced the Past Grand Exalted Rulers and their wives.

Grand Exalted Ruler Leonard Bristol reported the achievements of the past year. He was the featured speaker during the public opening ceremonies Sunday night.

"For the 40th consecutive year, we have achieved a net gain in membership," GER Bristol said. The Order had a net gain of over 10,000 members.

The Golden Anniversary of the Elks National Foundation proved to be the greatest in history. Total contributions were in excess of \$3.369 million. This amounted to \$1.8668 per member, surpassing the goal of \$1.50 per member.

GER Bristol praised the various committees for their "Continued Commitment to Effort and Enthusiasm."

"The Order of Elks has indeed grown and prospered," GER Bristol said. "It has become strong and great, woven into the fabric of American life, and a vital piece of Americana."

The Greater Dallas Rotary Chorus, under the direction of Dr. Travis Shelton, thrilled the huge audience with a number of vocal selections. They brought the audience to its feet for a standing ovation.

A Texas welcome was extended by C. J. Butler, president of the Texas State Elks Association. Opening intro-

ductions were by Edward M. Schlieter of New Braunfels, TX, Lodge, vice chairman, Board of Grand Trustees.

The Pledge to the Flag was led by Grand Esq. Olley C. Anderson of Austin, TX, and the Invocation and Benediction was by the Rev. Father John Moeder, Grand Chaplain.

Organ music was by Ramon "Red" Ringo of Brazil, IN, a resident of the Elks National Home. The Drill Team from Pottstown, PA, Lodge No. 814, assisted in the program.

Monday Highlights

Delegates greeted a parade of state flags, plus Old Glory, with wave after wave of cheers and applause. The pa-

The chairman is Yubi G. Separovich of Sacramento, CA, Lodge No. 6.

Robert Grafton of North Palm Beach, FL, Lodge No. 2069, was unanimously elected Grand Exalted Ruler. By coincidence, his election came on the 31st anniversary of his initiation into Elksdom.

President of the Florida Senate, Brother Philip D. Lewis, made the nomination. It was seconded by Edward C. Alexander from Great Falls, MT, Lodge No. 214, Chief Justice of the Grand Forum.

Brother Grafton's election triggered a convention floor demonstration by Florida Elks in bright orange jackets.

The acceptance speech of the new Grand Exalted Ruler has previously appeared in *The Elks Magazine*.

Other new officers named were: Frank A. Dorlarque of Anaconda, MT, Lodge No. 239, Grand Est. Lead. Kt.; Art M. Olson of Ely, NV, Lodge No. 1469, Grand Est. Loyal Kt.; Elmo M. Angele of Lakeview, OR, Lodge No. 1536, Grand Est. Lect. Kt., and Stanley F. Kocur of East Chicago, IN, Lodge No. 981, Grand Secy. (third term).

Also, William H. Collisson of Linton, IN, Lodge No. 866, Grand Treas. (second term); Ronald E. Simpson of Portsmouth, NH, Lodge No. 97, Grand Inner Guard; Wendell G. White of Muscatine, IA, Lodge No. 304, Grand Tiler, and the Rev. B. A. Erpen of Borger, TX, Lodge No. 1581, Grand Chaplain.

Elected to four-year terms on the Board of Grand Trustees were John T. Traynor of Devils Lake, ND, Lodge No. 1216, and Robert L. Smith of McAlester, OK, Lodge No. 533.

Carl Vaughn of North Palm Beach, FL, was appointed Secretary to the Grand Exalted Ruler-Elect.

The following appointments were confirmed by the delegates:

- ◎ PGER Raymond C. Dobson to a five-year term as a member of the Elks Memorial and Publication Commission.
- ◎ PGER E. Gene Fournace to a seven-year term as a trustee of the Elks National Foundation.
- ◎ PGER Ronald J. Dunn to a seven-year term as a member of the Elks National Service Commission.
- ◎ Edward W. Connolly of Livingston, NJ, Lodge No. 1855, to a five-year term as a Justice of the Grand Forum.
- ◎ Donald M. Nemitz of Clayton, MO, Lodge No. 1881, to fill an unexpired four-year term of Brother Grafton as Justice of the Grand Forum.



Cheering delegates greeted their various state flags as they were presented at the Monday meeting. The GL Americanism Committee presented Old Glory to the enthusiastic audience.

Delegates are shown registering at the convention. Nearly 18,000 members were in attendance.

triotic demonstration sponsored by the Americanism Committee opened the Monday meeting.

Representatives from distant places, which included Puerto Rico, Canal Zone, Guam, Hawaii and Alaska, were recognized by GER Bristol. Also recognized were the Exalted Rulers of the new lodges chartered during the year.

Earl W. Nowell of Fresno, CA, Lodge No. 439, announced that 23 new lodges had been instituted, resulting in a 40 percent net gain in membership.

Approved was a resolution creating a new Committee on Government Relations. The action was presented by Raymond V. Arnold of Jackson, MI, Lodge No. 113, chairman of the Committee on Judiciary.

GER Bristol immediately appointed the committee so they could begin work at once to implement a program.



First Family



Presenting Elksdom's new first family. From the left are GER Robert Grafton and his wife, Pat, and their children, Beth, John and Mary.

Tuesday Highlights

Walter Hagerman of Ellensburg, WA, Lodge No. 1102, chairman of the Distribution Committee, made recommendations and referrals at the opening of the second day's meeting.

PGER Wade H. Kepner, chairman of the Elks National Memorial and Publication Commission, reported on the rising costs of producing and mailing *The Elks Magazine*.

Despite higher costs, revenues from the magazine paid for the maintenance of the Elks National Memorial Building in Chicago.

PGER Kepner cited the absolute necessity of updating membership lists.

Robert C. Grant of Cullman, AL, Lodge No. 1609, chairman of the GL Auditing and Accounting Committee, warned against financial losses in a lodge, and stressed that procedures outlined by the committee be followed.

The 50th anniversary year of the Elks National Foundation was the greatest year ever for contributions,

PGER John L. Walker, chairman of the Foundation Trustees, said in a preliminary report. A total of 1,073 lodges attained or exceeded the \$1.50 per member goal.

The largest budget for distribution ever, \$1,890,000, was adopted for the coming year.

Dale W. Blanton of San Rafael, CA, Lodge No. 1108, chairman of the Ritualistic Committee, announced the winners of the Eastern and Western Division ritualistic contests.

Muskegon, MI, Lodge No. 274, won first in the Eastern Division and Wabash, IN, No. 471, placed second.

First in the Western Division was Greeley, CO, No. 809, and Kearney, NE, No. 984, placed second.

The GL Lodge Activities Committee conducted seven nationwide contests, distributed over 50,000 membership card seals, 6,700 lapel pins and some 3,000 award certificates, according to Peter T. Affatato of Hicksville, NY, Lodge No. 1931, committee chairman.

Many of the awards were previously announced in *The Elks Magazine*.

State Americanism Contest winners were announced by Robert L. Smith of McAlester, OK, chairman of the GL Americanism Committee. They were: Arizona, first; Michigan, second, and Colorado, third.

Brother Smith's stirring report on Americanism brought the delegates to their feet with a double standing ovation.

Norman P. O'Brien of South Miami, FL, Lodge No. 1888, chairman of the GL State Associations Committee, noted that all but five associations now have a Business Practices Committee. He reported that 27 associations and 1,284 lodge officers completed the Officers Training Program.

State Association awards for the highest percentage of gain in the Elks National Foundation were announced. North Dakota Elks Association led the group in their membership category with 183 percent. The Philippine Republic in their membership category had the greatest percentage of new pledges, 8 percent.

Winners of the state association display booth contest were: Illinois, first; Nebraska, second, and California, third.

Winners of the state association bulletin contest were:

© Division I (Publications which are sold): Class A (more than quarterly): California-Hawaii, first; Ohio, second; and North Dakota, third. Class B (quarterly): Pennsylvania, first; Arizona, second.

© Division II (Publications which are not sold): Class A (more than quarterly): Colorado, first; Wisconsin, second, and Minnesota, third. Class B (quarterly): New Jersey, first; Georgia, second, and Michigan, third. Class C (less than quarterly): Nebraska, first; Oklahoma, second, and Alaska, third.

© Division III (advertising used): Class A (more than quarterly): Massachusetts, first; Washington, second, and Oregon, third. Class B (quarterly): Ida-



Committees & Commissions



The budget for the coming year was presented by the Board of Grand Trustees and approved by the Convention. Seated from the left are Edward M. Schlieter, vice chairman; H. Foster Sears, chairman; and Larry L. McBee, secretary. Standing, from the left, Frank Garland, approving member; A. Lewis Heisey, home member; Alfred J. Mattei, pension member; Alex M. Harman, Jr., building applications-east; and Marvin M. Lewis, building applications-west.



The Committee on Judiciary presented a number of changes in statutes for consideration. Seated are Raymond V. Arnold, left, chairman, and Eugene F. Costello. Standing, from the left, Robert J. Sabin, Bertil E. Johnson, Daniel B. Tammany, Seymour Nathanson, Lester C. Hess, Jr. and Wayne A. Westover, Jr.



The Elks National Memorial and Publication Commission discussed *The Elks Magazine* and the Memorial Building. Seated, from the left, are: PGER R. Leonard Bush, vice chairman; PGER Wade H. Kepner, chairman; and Jack Ryan, publisher-general manager of the magazine. Standing, left to right, Robert E. Boney, Raymond C. Dobson and Edward W. McCabe, all PGERs.



The outstanding activities of the Elks National Service Commission in preserving the Elks pledge to never forget hospitalized veterans were emphasized to the delegates. Seated, left, are PGER William J. Jernick, chairman-treasurer; PGER Ronald J. Dunn, center; and George M. Hall, director, right. Standing, left to right, Diron Avedisian, assistant director; and Gerald Strohm, Homer Huhn, Jr. and George B. Klein, all PGERs. PGER George I. Hall, vice chairman, and PGER Frank Hise were unable to attend.



The next Grand Lodge Session is to be held in New Orleans, July 20-24. Shown pointing out the area are, from the left, Bryan J. McKeogh, national convention director; Robert E. Boney, Robert A. Yothers and Robert G. Pruitt, all PGERs; and George Malekian, assistant director. Action on the convention floor created a Convention Commission. Named chairman emeritus for life was PGER George I. Hall. Other members are PGERs Pruitt, Boney, Glenn L. Miller, Yothers and Leonard Bristol.



The Grand Forum reorganized during the convention after Robert Grafton resigned when he was elected Grand Exalted Ruler. Donald Nemitz of Clayton, MO, far right, was named to replace him. He is shown conferring, left to right, with members Sidney J. Nicholson of Florence, OR; William J. Steinbrecher of New Hyde Park, NY; and Robert B. Webb of Santa Ana, CA. Edward C. Alexander of Great Falls, MT, the retiring chief justice, was not present when the photograph was taken.

Highlights



PGER William A. Wall, sponsor of the state of Florida, left, installed the new officers. He is shown placing the Grand Exalted Ruler's jewel on Robert Grafton.



Mrs. Ginny Bristol pins a Past Grand Exalted Ruler's badge on her husband, Leonard.



Philip D. Lewis, president of the senate of the state of Florida, left, made the nomination speech.

Edward C. Alexander of Great Falls, MT, Chief Justice of the Grand Forum, right, seconded the nomination.

Brother Grafton, right, acknowledges the well-wishes of the members on his election as Grand Exalted Ruler. A delegation of distinguished Elks, headed by PGER William A. Wall, escorted him to the podium.

ho, first; Montana, second, and Utah, third. Class C (less than quarterly): North Carolina, first.

Winning the Veterans Achievement Awards were: Virginia City, MT, No. 390 (under 601 members); Westminster, CA, No. 2346 (601 to 1,000 members), and Milwaukie, OR, No. 2032 (over 1,000 members).

Wednesday Highlights

John T. Traynor, of Devils Lake, ND, Lodge No. 1216, chairman of the GL Youth Activities Committee, reported the increases in the number of youth being touched by Elkdom's many youth programs, including Teenager of the Month/Year and a drug abuse educa-



tion program. Elks spent well over \$3 million in widely-diversified youth programs.

Over 2.6 million youth participated in the 1978-79 Hoop Shoot Contest, Gerald L. Powell of Peru, IN, Lodge No. 365, national director, reported.

The five outstanding lodges with the highest number of participants were: Under 300 members, Denton, TX, Lodge No. 2446 (11,909 boys and girls); 301-600, Redford (Detroit), MI, Lodge No. 2097 (31,618); 601-1,000, Southern Pines, NC, Lodge No. 1692 (8,322); 1001-2,000, Greensboro, NC, Lodge No. 602 (16,326); over 2,000, Phoenix, AZ, Lodge No. 335 (7,681).

Elks reaffirmed their vow that, "So long as there is a disabled veteran in our hospitals, the Benevolent and Protective Order of Elks will never forget him."

In a report for the Elks National Service Commission, PGER William J. Jernick, chairman-treasurer, asked and received approval for the 29th year for the assessment of \$1 per member, in the event it is needed for defense or a major disaster. He urged lodges to observe November as Veterans Remembrance Month.

In the second portion of a report on the Elks National Foundation, PGER Walker said that beginning the Foundation's 50th anniversary, "The Great Heart of Elkdom continued to grow and to beat stronger throughout the year."

PGER Robert E. Boney, sponsor of the state of Utah, introduced Marcie Beck, sponsored by Cottonwood (Murray), UT, Lodge No. 2344, first-place girl winner in the Elks National Foundation Most Valuable Student Contest.

Kevin Ambler, sponsored by Palm Springs, CA, Lodge No. 1905, winner in the boys' division, was introduced by PGER Horace R. Wisely, representing California.

A standing and enthusiastic ovation was given by the Elks and their ladies, as each expressed their thanks to the order.

Thursday Highlights

Howard W. Nunez of Albuquerque, NM, Lodge No. 461, chairman of the GL Committee on Credentials, reported that total attendance came to 17,432. H. Foster Sears of Macomb, IL, Lodge No. 1009, chairman of the Board of Grand Trustees, announced redistricting, Lodge name and number changes. GL per capita dues of \$3 per member will remain the same in the coming



The New Grand Lodge officers are shown above. Seated, from the left, are: Frank A. Dorlarque of Anaconda, MT, Grand Est. Lead. Kt.; Art M. Olson of Ely, NV, Grand Est. Loyal Kt.; Robert Grafton of North Palm Beach, FL, Lodge, GER; Elmo M. Angele of Lakeview, OR, Grand Est. Lect. Kt. and Stanley F. Kocur of East Chicago, IN, Grand Secy. Standing, left to right, William H. Collisson of Linton, IN, Grand Treas.; Rev. B. A. Erpen of Borger, TX, Grand Chaplain; Ronald E. Simpson of Portsmouth, NH, Grand Inner Guard; Wendell G. White of Muscatine, IA, Grand Tiler; John T. Traynor of Devils Lake, ND, and Robert L. Smith of McAlester, OK, Grand Trustees, and Carl Vaughn, also of North Palm Beach, Secy. to the GER.



For the first time in history, the new District Deputies were sworn in immediately after the Grand Lodge officers. It was an impressive sight in the huge auditorium.

year, and delegates approved the budget as presented.

Resolutions honoring Brother Sears and Edward M. Schlieter of New Braunfels, TX, Lodge No. 2279, who are retiring from the board, were given unanimous approval.

First place in the national ritual contest went to Greeley, CO, Lodge No. 809, with a score of 95.0195. Kearney, NE, Lodge No. 984, was second with a score of 94.5214. Placing third was Muskegon, MI, Lodge No. 274, scoring 93.9522, and fourth was Wabash, IN, Lodge No. 471, whose score was 92.3454.

Dale W. Blanton of San Rafael, CA, Lodge No. 1108, chairman of the GL Ritualistic Committee, also announced that new rituals and manuals were available. There are slight changes.

Delegates considered a number of resolutions and changes presented by



Literally hundreds of Florida Elks in bright orange jackets jammed the convention floor in a parade and demonstration when Robert Grafton of North Palm Beach, FL, Lodge was elected Grand Exalted Ruler.

Raymond V. Arnold, chairman of the Committee on Judiciary (See page 32).

Unanimous approval was given to a resolution presented by Donald Nemitz of Clayton, MO, Lodge No. 1881, GL Resolutions Committee chairman, lauding the Convention Committee, Texas Elks and other participants for an outstanding convention.

PGER William A. Wall installed the new officers. GER Grafton immediately installed the new District Deputies.

He also announced the members of the new GL Convention Commission. They are PGERs Robert A. Yothers, one year; Robert G. Pruitt, two years; Robert E. Boney, three years; Glenn L. Miller, four years, and Leonard Bristol, five years. PGER George I. Hall was named chairman emeritus for life.

PGER Smith, Advisory Council chairman, presented a resolution on behalf of PGERs Hall and Ronald Dunn, hon-

Highlights

oring PGER Bristol for his past efforts. It received unanimous approval.

George Malekian, New York State Elks Association president, and others, presented GER Bristol with the keys to a new four-wheel drive vehicle.

Charles S. Pride, PSP of the Florida State Elks Association, presented GER Grafton with the keys to a new auto.

Other gifts were also presented. ■

Greeley, CO, Lodge No. 809 captured the national ritualistic crown. Shown, kneeling, are acting ER Philip L. Brewer, left, and Esq. Stephan Paranto. Standing, left to right, PER Robert E. Stout of Littleton, CO, Lodge No. 1650, assistant coach; Earl H. Kindsfater, Est. Lead. Kt.; Chester March, Est. Loyal Kt.; Warner Cunningham, Est. Lect. Kt.; PER Lewis E. Kitts, coach and substitute chaplain; Dave McArdler, Inner Guard and Don Anderson, candidate.



Greeley's acting ER, Philip L. Brewer, above, received the PGER Raymond Benjamin plaque from Napa, CA, ER Gene Irby; while above right, Brother Brewer received the trophy for the highest ER score in the contest. The award was presented by PGER R. Leonard Bush on behalf of Inglewood, CA, Lodge No. 1492.



ER Robert M. Speer, left, of Tucson, AZ, Lodge No. 385, presented the John D. Frakes Coach's Award to PER Lewis E. Kitts of Greeley.



AWARDS



FLAG DAY BROCHURE CONTEST

- Division I
1. Sand Springs, OK
 2. Lindsay, OK
 3. Liberty, TX
- Division II
1. Rome, NY
 2. Carlinsville, IL
 3. Westminster, MD
- Division III
1. Providence, RI
 2. Huntsville, AL
 3. El Paso, TX
- Division IV
1. Pasco, WA
 2. Grand Rapids, MI
 3. Anderson, IN
- Division V
1. Phoenix, AZ
 2. Fresno, CA
 3. Gresham, OR

HIGHEST NUMERICAL NET GAIN IN MEMBERSHIP

- Lodges with 300 or less members:
1. Manila, PI
 2. Titusville, FL
 3. Fort Smith, AR
- Lodges with 301 to 600 members:
1. Albert Lea, MN
 2. Manasquan, NJ
 3. Maumee, OH
- Lodges with 601 to 1,000 members:
1. Glens Falls, NY
 2. Englewood, FL
 3. Fort Walton, FL
- Lodges with 1,001 to 2,000 members:
1. Kokomo, IN
 2. Boise, ID
 3. Lowell, MA
- Lodges with over 2,000 members:
1. Eugene, OR
 2. Ballard (Seattle), WA
 3. Sarasota, FL

ELKS NATIONAL FOUNDATION TOP LODGES IN PERCENTAGE OF NEW PLEDGES SIGNED

- Lodges with 300 or less members:
1. Seminole, OK
 2. Pulaski, TN
 3. Amarillo, TX
- Lodges with 301 to 600 members:
1. Atchison, KS
 2. Skagway, AK
 3. Pinellas Park, FL
- Lodges with 601 to 1,000 members:
1. Plainfield, IN
 2. Sheboygan, WI
 3. Millinocket, ME
- Lodges with 1,001 to 2,000 members:
1. Billerica, MA
 2. Chula Vista, CA
 3. Indianapolis, IN
- Lodges with 2,001 or more members:
1. Plymouth, MI
 2. San Mateo, CA
 3. Clawson-Troy, MI

TOP STATES

1. Maine
2. Arizona
3. Alaska

California was given a special award for reaching \$2.723 per member and the largest amount contributed by a single state.

ATTENDANCE

As reported by the Committee on Credentials

Grand Exalted Ruler.....	1
Past Grand Exalted Rulers.....	19
Grand Lodge Officers.....	23
Grand Lodge Committeemen.....	67
Special Deputies	28
District Deputies Designate.....	243
Representatives	1,988
Alternate Representatives	54
Members of Grand Lodge.....	1,052
Other Elks, ladies and guests.....	13,958
Grand Total.....	17,432

YOUTH ACTIVITIES WINNERS Year-Around Programs

- Lodges with 300 or less members:
1. New Orleans (West Bank), LA
 2. Mesquite, TX
 3. Tenafly, NJ
- Lodges with 301 to 600 members:
1. Lawton, OK
 2. Holbrook, AZ
 3. Blackfoot, ID
- Lodges with 601 to 1,000 members:
1. Derry-Salem, NH
 2. Port Jervis, NY
 3. Mainland, TX
- Lodges with 1,001 to 2,000 members:
1. Oswego, NY
 2. Burbank, CA
 3. Huntsville, AL
- Lodges with over 2,000 members:
1. Auburn, WA
 2. Tucson, AZ
 3. Lincoln, NE

ELKS NATIONAL YOUTH WEEK WINNERS

- Lodges with 300 or less members:
1. Holbrook, AZ
 2. New Orleans (West Bank), LA
 3. Mesquite, TX
- Lodges with 301 to 600 members:
1. Perryton, TX
 2. Bayonne, NJ
 3. Newnan, GA
- Lodges with 601 to 1,000 members:
1. Van Wert, OH
 2. Maryvale (Phoenix), AZ
 3. Milwaukee, WI
- Lodges with 1,001 to 2,000 members:
1. Falls City, NE
 2. Fairbury, NE
 3. Mesa, AZ
- Lodges with over 2,000 members:
1. Charleston, SC
 2. Phoenix, AZ
 3. Tucson, AZ
- State Associations
1. Arizona

AMERICANISM BROCHURE CONTEST

- Division I
1. Plano, TX
 2. Azusa, CA
 3. Forks, WA
- Division II
1. Hudson, NY
 2. Mainland, TX
 3. Atlanta-Buckhead, GA
- Division III
1. Paramount, CA
 2. Mesa, AZ
 3. Warren, OH
- Division IV
1. Watervliet, NY
 2. Grand Rapids, MI
 3. Yankton, SD
- Division V
1. Albuquerque, NM
 2. Sioux Falls, SD
 3. Bordentown, NJ

HIGHEST PERCENTAGE MEMBERSHIP GAIN

- Lodges with 300 or less members:
1. Plentywood, MT
 2. Mountain Brook (Birmingham), AL
 3. Manila, PI
- Lodges with 301 to 600 members:
1. Albert Lea, MN
 2. Greater Wildwood, NJ
 3. Manasquan, NJ
- Lodges with 601 to 1,000 members:
1. Glens Falls, NY
 2. Englewood, FL
 3. Fort Walton, FL
- Lodges with 1,001 to 2,000 members:
1. Kokomo, IN
 2. Weymouth, MA
 3. Lowell, MA
- Lodges with over 2,000 members:
1. Ballard (Seattle), WA
 2. Eugene, OR
 3. Scottsbluff, NE

HIGHLIGHTS



Elkdorm's newest Past Grand Exalted Ruler was accorded a special seat. He is now low man on the totem pole.



PGER Homer Huhn, Jr., center, pins the new PGER Leonard Bristol as a new member of the "Usterwuzers Club." PGER Gerald Strohm, right, stands ready to relieve the new member of his dues.



"I'd rather shoot baskets than make a speech," said Kelly Lane of Vincennes, IN. Kelly was a first-place national winner of the Elks Hoop Shoot Contest two years in a row. GER Bristol presented her with her trophy.



A delegation of New York Elks presented GER Bristol with the keys to a new four-wheel drive vehicle. Left, is George Malekian, president of the New York State Elks Association, and, right, is Francis P. Hart, Past Grand Trustee and past state president.



Mrs. Gail Russo of Slidell, LA, won a trip to Spain for two at the ladies' party on Monday. The trip was donated by Great American Travel Bureau.

Horror

(Continued from page 8)

horror films) can hurt children," insisted Karloff, who played many a creep, from Frankenstein to Fu Man-chu, in his time. "These films are so obviously outside anyone's personal experience that they can't harm anyone, including the youngsters. Violence, rape, and murder can happen on your street. But you aren't apt to walk into a monster tonight."

The horror craze gained momentum over two decades ago, due primarily to Samuel Z. Arkoff and the late James H. Nicholson, the heads of American International Pictures. Some of their early titles, as eyebrow-raising as they were hair-raising, were *The Beast with a Million Eyes*; *The Day the World Ended*; *Blood of Dracula*; *Teenage Frankenstein*; *Viking Woman and the Sea Serpent*.

These two shocker pioneers, in four years, parlayed \$3000 into a million-dollar film factory and a national craze. Their secret weapon, so to speak, was the "package," or double feature.

"Our first release, *Apache Woman*, taught us our lesson," recalls Arkoff. "A single feature usually gets played—and played down—as the second feature. But when we came out with our first package—*The Day the World Ended* and *Phantom From 10,000 Leagues*—we were in business. Basically, we're merchandisers. Titles, monsters and gimmicks are the stars. If these can't attract, we have missed the boat."

During the past several years there has been a rash of films featuring terrible tots, so to speak. It started with *The Exorcist*, the central plot of which was simple and gruesome. Regan (played by Linda Blair in the movie) was a 12-year-old girl who was inexplicably afflicted by violent spasms and by mysterious movements of her bedroom furniture. Her mother (Ellen Burstyn), an actress, took Regan to brain specialists and then to psychiatrists, but no one could explain or cure her strange affliction.

Regan grew more violent. Her tongue furred and flicked like a serpent's; her face filled with blood, pus and welts. In a harsh, husky voice she screamed obscenities. She punched a psychiatrist in the groin and hurled her mother's director to his death from her window.

The film was a box office smash. Serpentine lines formed outside theaters where crowds waited for as long as four hours just to buy tickets to a two-hour horror show. Many moviegoers—men and women alike—fainted before the film was over.

(Continued on page 37)

Introducing . . . The Solar Alarm Chronometer

- Light Energized
- Electronic Quartz Accuracy
- 24 hour alarm

**A personal alarm
and time system
powered by light.**



**Only
\$49.95**

You can't wear a more accurate watch. Plus this new LCD chronometer has a built in 24-hour alarm and personal reminder system. And you no longer have to worry about batteries failing because this watch is constantly being recharged by light. A true scientific break thru.

Forget about losing time

The time base is a finely tuned quartz crystal, trimmed by the manufacturer electronically to an accuracy of 5 seconds per month. And the manufacturer stands behind this accuracy with a one year limited warranty plus a 5 year replacement warrant on the micro-rechargeable energy cells.

Who is the Manufacturer

U.I.T. has been the innovator in the digital watch industry for years. U.I.T. is the prime manufacturer, assembler and importer of LCD watches. U.I.T. has been the pioneers of solar powered watches where "light energy" recharges micro-energy cells contained in the watch. A system so efficient they are able to offer the unheard of 5 year warranty.

Forget about batteries

The new solar-alarm is powered by micro-energy cells which are constantly being recharged from available light. Not just solar light but ordinary room light. You never need to worry about batteries.

Forget about changing technology

This solar-alarm watch uses all of the

latest technology in electronics and engineering. The programmed time measuring features include hours, minutes, and pulsating seconds plus the month and date displayed instantly with the touch of a button. The large liquid crystal display constantly shows the time in large easy to read numerals. A special night light command button illuminates the dial for night viewing.

Forget about being late

The most unique function of this solar chronometer is the alarm system. The 24 hour alarm system is easy to set without disturbing the time function. And it sounds with a pleasant electronic beep precisely at the pre-set time. Your own personal alarm system will automatically beep you at the right time for "on-time" punctuality, so important with today's busy schedules. You may never be late again.

Test it for 2,592,000 seconds

Take 30 full days (2,592,000 seconds) to confirm the accuracy and utility of this fine timepiece. If you doubt the quality, merely return it for a full refund.

If you have been looking for that special opportunity to own a chronometer of the future here is your chance! Available in silver or gold tone with fashion flex band. All U.I.T. timepieces feature ultra-thin design, rugged shock proof engineering and water resistant construction. The solar-alarm watch is priced at \$49.95 each plus \$2.50 shipping & handling. (IL. residents add 5% sales tax).

**CAMBRIDGE
INTERNATIONAL, Inc.**

Dept. E10

8700 Waukegan Road, Morton Grove, Illinois 60053 (312) 966-5510

**Credit card customers call operator #219 toll free
800-241-8444 (In Ga. call 1-800-323-9123)**

Clip & mail to: Cambridge International, Inc. Dept. E10
8700 Waukegan Rd., Morton Grove, Ill. 60053

Please send me _____ Solar-Alarm Watches at \$49.95 each plus \$2.50 shipping & handling. I understand that I may return my purchase within 30 days for full refund.

silver tone gold tone

Check or MO enclosed. Change to: Visa Master Charge

Account # _____ Exp. Date _____

Name _____

Address _____

City _____ State _____ Zip _____

Signature _____

© Cambridge International, Inc. 1978

204

Community Service Contest D



My Brothers, there are many ways to be of outstanding service in your community. To be really effective requires that there be personal involvement on the part of our officers and general membership. To give monetary support alone is not enough. The community needs your minds and talents in support of such programs as Boy and Girl Scouts, baseball, basketball, football, and swimming leagues, Youth Week, nursing home, senior citizens, and veterans hospital visitations, and honoring law enforcement officers and fire fighters.

The list could go on and on; it is limited only by your imagination.

Be sure that your fellow citizens know you are dedicated Elks who are working to make a better community. There is an awards program (Contest D) for the best community service programs in the various lodge categories. Endeavor to get good media coverage of your lodge's activities. It will be a consideration in the judging for the contest.

All entries must be received by March 15, 1980. You should start getting material together for your brochure at once. The awards will be presented at the New Orleans Convention in July, 1980.

Stanley Mascoe, Member
GL Lodge Activities Committee

Amendments to the Grand Lodge Statutes

Adopted at Dallas, TX, 1979

In Convention assembled at Dallas, Texas, the Grand Lodge on July 19, 1979, adopted Statutory Amendments which become binding upon Members of the Order, Subordinate Lodges and their related facilities 30 days thereafter. The Amendments, as adopted, will be incorporated in the 1979 Reissue of the Grand Lodge Statutes. There follows a digest of the Grand Lodge action as an aid to all concerned.

Sections 17 and 40e

As amended, deletes "A Committee on Convention" and establishes an "Elks National Convention Commission," and provides for its nomination and duties.

Sections 41 and 47d

As amended, deletes "New Lodges Committee" and establishes "Lodge Development Committee," having general charge of organization and institution of new Lodges, the stimulation of membership growth and the control of lapsation.

Sections 41 and 47f

As amended, establishes a new committee, "Government Relations," charged with the duties and responsibilities of implementing a government relations program of the Order and in conjunction with other organizations.

Section 48 (9)

As amended, the District Deputy maximum transportation allowance increased to 17¢ per mile.

Section 118

As amended, the Exalted Ruler may not appoint members to exemplify the Ritual of Initiation.

Section 119

As amended, gives the Lodge power to vacate the position of any officer who was replaced by an Acting Officer under Section 123 and who is determined by the Lodge to be unable to complete his term of office by reason of such disability or incapacity.

Section 126

As amended, a Lodge may change its By-Laws to provide for signing of checks by the Treasurer or by a member of the Board of Trustees to be designated by the Treasurer, and executing a bond in the same amount as the Treasurer.

Also, a Lodge may change its By-Laws to provide for payment of bills against the Lodge incurred in the normal and usual operation of the Lodge and Club upon approval by the Board of Trustees, without first obtaining Lodge approval, with report of payment to the next Lodge session.

Section 153

As amended, provides for new

Section 153b giving the Lodge the right to elect to use group balloting for applicants, using one or more ballot boxes, provided there are ten or more applicants to be balloted upon. It also provides for rebaloting on individual applicants if the group ballot has three or more black balls or cubes.

Section 209

As amended, provides that the actions and decisions of the governing body pertaining to an employment relationship is exempted from the control and direction of the Lodge.

Should it be necessary prior to the availability of the 1979 Reissue of the Statutes Annotated, copies of the Amendments as adopted may be obtained upon request to Grand Secretary, Stanley F. Kocur.

The following resolutions were rejected:

To allow use of printed ballot in Grand Lodge Statutes Sec. 153.

To allow administration costs not to exceed \$5.00 to be paid by any member who would pay his dues semi-annually.

A resolution was withdrawn providing for appointment of Acting Exalted Ruler in case of disability or incapacity.

Raymond V. Arnold
Chairman
Committee on Judiciary

NEWS OF THE LODGES

Officers of law were honored at two lodges recently. **Alameda, CA, Elks** sponsored Law Enforcement Night to show their appreciation for local civic leaders and police officers. ER Robert Carmignani welcomed Mayor C. J. Corica and Councilpeople Amy Stone, Rich Sherratt, and Ann Diamant. At **Queens Borough (Elmhurst), NY, Lodge**, local judges were honored on Judiciary Night. ER Paul Di Frenza, Chm. Joseph Quattrocchi, Esq. James Healy, and Esq. Julius Eingoren welcomed Justices of the Supreme Court Francis Smith and SDGER George Balbach and Hon. PER John Scileppi, associate judge of the court of appeals.

Two lodges recently honored individual members for their many years of dedicated service. **Westwood, NJ, Lodge** held a testimonial dinner in honor of Brother Roy Bentley, who has served as the lodge secretary for 13 years. **Anaheim, CA, Brothers** presented a plaque of appreciation to Tiler Ross Kopfer during a special ceremony held on the night of the installation of new officers. Eighteen PERS were present to congratulate Brother Kopfer for 25 years as the lodge's tiler.

For their outstanding work in bringing help to victims of cerebral palsy, the **New York State Elks Association** received the State Community Service Award for 1979. Major Projects Chm. Dale Hartpence accepted the award from the United Cerebral Palsy Association of New York. At the state convention, **Ramapo Valley (Suffern), NY, Lodge** took second place for the amount of money donated per member to the major project. With 125 members, Ramapo Valley Elks contributed a total of \$3,250.

Family members were part of an initiation ceremony at **Grand Junction, CO, Lodge**. GL Committeeman Maurice Gardner served as the presiding officer at the initiation of a class which

included his grandson David. On hand to offer congratulations were the new Brother's father, Brother Edward Gardner, and great-grandfather Brother Harry Gardner.

The **Brothers of Bowling Green, OH, Lodge** honored widows of Elks at their first annual forget-me-not luncheon re-



The Stutsman County Fair

cently. The afternoon event was coordinated by Chm. Thomas Philo, then-ER Walter Beeker, Esq. Robert Juhasz, and Organist Jerry Waltz. Mrs. Carol Roth presented a welcome address on behalf of the Elks' ladies.

The merry-go-round was Sheridan's (above, left) favorite ride at the Stutsman County Fair. Every year, **Jamestown, ND, Lodge** brings the handicapped children from Camp Grassick, the state major project, to enjoy the rides, exhibits, and food at the fair.

A fishing derby sponsored by **New Smyrna Beach, FL, Lodge** was a spe-

cial adventure for 16 youngsters from the Harry-Anna Crippled Children's Hospital. Fishing from shore in wheelchairs, the children were awarded trophies for their sporting efforts. The event took place at the lakeside home of Wade and Karen Bowers.

Honored by **Tucson, AZ, Elks** was Detective Lewis Adams, who received the lodge's Outstanding Officer of the Year Award. Officer Adams was commended for outstanding service to citizens through his work as a police detective. Chm. Joe Bruggeman presented the officer with a plaque, a gift certificate, and a certificate of appreciation from the Arizona Elks Association.

Contributions to those in need continue to display the spirit of Elkdom. **Auburn, NY, Elks** contributed a total of \$800 to various local organizations. Among the recipients were the local VA hospital, the Cerebral Palsy Foundation, the Heart Fund, and the Arthritis Foundation. At community College in Denver, CO, Jose Abeyta Jr. received an Associate of Arts degree in a new wheelchair which was provided by **Westminster, CO, Elks**. Brother Gerald Dotson, professor of biology at the college, presented the wheelchair to the new graduate.

Carteret, NJ, Lodge received a check for \$500 from the Elks' ladies for the lodge's building fund. ER Philip Mansueto accepted the contribution from Pres. Gladys Dietz.

Funds raised by **Lebanon, OH, Lodge** when they held their annual Crippled Children Stag were divided for donation to seven different charities recently. The recipients of \$500 checks were the Green Knoll and Hopewell schools, the Emily Jones Home for Children, the Doty House for Handicapped Children, the Mary Haven Youth Center, the Handicapped Children's Home at Carlisle, and the Countryside YMCA.

To help with the operation of the Senior Citizens Title VII Food Program, **Ephrata, WA, Lodge** opened their dining facilities for the luncheons. The hot meal is served daily and is often enjoyed by 20 local senior citizens.



EIGHT MEMBERS of Boy Scout Troop No. 80 who became Eagle Scouts recently were congratulated by their sponsor, Park Ridge, NJ, Lodge. Eagle Scouts Anthony Agolia, Scott Bishop, Jeffrey Davis, Rick D'Emilia, Todd Hansen, Gary Leach, John Leva, and Peter Ludwig thanked (back row, from left) Scoutmaster Thomas Mazzucco, Est. Lead. Kt. George Scheidle, Brother Charles Naden, institutional representative, Esq. and Chm. Jean Sheridan, and ER Neil Andrito for their support. The Scouts use the lodge facilities for meetings and activities.



THE FIRST- and third-place trophies for performance at the New York Capitol District Fourth Annual Bowling Tournament were earned by **Colonie, NY, Lodge**. Prizes were presented by ER Lee Lape (center) of Colonie Lodge to Lou Piroha (left), captain of the third-place team, and Ed Klimek, captain of the first-place team. The competition was hosted by the Brothers of Watervliet Lodge.



CONTRIBUTIONS to the California-Hawaii major project, vision screening and support of handicapped children, were made by the Brothers and the Elks' ladies of **Oceanside, CA, Lodge** recently. ER Kenneth Goodale presented \$13,034, raised by the Brothers, and \$2,796, raised by the ladies, to Chm. Lawrence Stevens and SP Robert Robb.



A CERTIFICATE of appreciation was presented to Michigan SP William Murray (center) by Mr. William Keene (right), assistant director of voluntary services at the Allen Park Veterans Hospital, recently. Mr. Keene thanked the SP for his assistance to the hospital during the past year. PGER Frank Hise (left) was on hand for the presentation.



CITIZENS of Whittier, CA, joined the Brothers of the local lodge in supporting the area's youth recently. Mayor Zelda Murphy (right) presented an official proclamation expressing the city's approbation of the Brothers' youth activities. ER Robert Becker and PDD Charles Booth thanked Ms. Murphy for her cooperation.



WASHINGTON, Missouri, Lodge's 50th anniversary was celebrated recently. PGER Edward McCabe (fifth from left) joined celebrants (from left) James Krafft, Frederick Baumann, ER Alvin Rover, Elks' ladies Pres. Hazel Rover, Alvin Nieburg, and Carl Hausmann for the occasion. Brothers Krafft, Baumann, Nieburg, and Hausmann are the four remaining charter members of the lodge.



A WHEELCHAIR was donated to Wendy Fosgate by Clinton, NJ, Lodge recently. Est. Lead. Kt. and Chm. C. Westerfield (left) and then-ER Anthony Rizzo (right) presented the wheelchair to Wendy. Wendy's mother, Mrs. Betty Fosgate (standing, center), joined her daughter in thanking the Brothers for the gift.



FOR SERVICE to the community, Panama Canal Zone (Balboa), CZ, Lodge received a Panama Canal Zone Public Service Award recently. Governor Harold Parfitt (right) presented the citation to ER John Duda. The awards ceremonies were held in the rotunda of the Administration Building and honored several groups and individuals for community work.



FOUR SONS of Brother William O'Toole (front row, center), a 30-year member of Albany, NY, Lodge, were initiated into the order recently. Congratulations were offered to (back row, from left) Thomas, John, James, William (front row, left) and Michael O'Toole (right). PER and Secy. James Dalton (second from left) and ER Brian Noonan welcomed the O'Tooles to Elklom.



THE AWARD for the California-Hawaii Elks Association Most Valuable Student Contest was presented to Robert Cowan (left) recently. A \$500 check accompanied the plaque, and the honored student received an additional \$1,000 at the national level of competition as well as \$400 from his sponsor, San Mateo Lodge. ER Edwin Kremetz was on hand for the presentation of the award.



BIRTHDAY wishes were offered to PER Eugene Swegman Sr. of Janesville, WI, Lodge recently. The 92-year-old Brother received a plaque commemorating his 70 years as an Elk from PER Leon Glowacki and ER Henry Chrostowski. Congratulations were also offered by SP Don Grosenick and Past Grand Chap. Rev. John Moeder, who sent a special letter to the honored Elk.



PDD ERNEST GRADY of the Elks National Home received a special request from Paul Kelly, past president of the Virginia Elks Boys Camp, recently. One of Brother Grady's paintings depicts the camp's recreation hall, and in response to Brother Kelly's request, the artist painted 30 similar pictures so each lodge in the state could have one to display. Brother Grady also designed the camp seal included in the paintings.



THE BROTHERS of Pendleton, OR, Lodge greeted then-GER Leonard Bristol (right) when he visited them before the completion of his term. ER James White introduced the national dignitary to his fellow lodge members.



A CHECK for \$10,000 was presented to State Major Projects Chm. Lawrence Stevens (right) by ER Richard Huffman (center) on behalf of Vallejo, CA, Lodge recently. The donation was the result of Vallejo Brothers' fund-raising efforts of the past year. Then-SP Robert Robb was on hand at the presentation and praised the Brothers for their success.



OVER 500 people enjoyed Col-
onie, NY, Lodge's family picnic
recently. There were games and
rides for the children, a softball
game was played by the adults,
and a varied selection of foods
was feasted on by all. Commit-
teemen (from left) Co-chm. and
Chap. Don Gula, Art Phelan,
In. Gd. Ron Olsen, ER Lee
Lape, House Chm. John Clancy,
and Tony Styno organized the
event, which helped raise funds
for the state major project.

(Continued on page 48)

B.P.O.E. PARTY FAVORS

On party night favor your ladies with a beautiful Elks emblem gift. Bright, silvery Rhodium clover design pin with large, gleaming rhinestones. Miniature enameled emblem in center. Pin fastener with safety catch.



(E-731) Each \$3.30

Price includes postage

Quantity Prices Furnished on Request.

And when planning a party, you'll want emblem decorations, napkins, place mats, cards.

Write for Catalog



RUSSELL-HAMPTON CO.

Dept. E, 2550 Wisconsin Avenue

Downers Grove, Illinois 60515

(A Chicago Suburb)

PROTECT YOUR VALUABLES



Avoid losses. Protect valuables and records from burglary or fire with a **SECURITY CUBE**. Furniture cabinet conceals a steel safe. Looks like an end table. Combination lock prevents entry. U.L. Labs. fire tested. Model Q-7 only \$179.95. **FREE DELIVERY**. Send for **FREE CATALOG**.

THE J. GOODMAN CO., Dept. EL-5
BOX 88, LIVINGSTON, N.J. 07039

THE ORIGINAL BASEMENT TOILET

Genuine Porcelain



FLUSHES UP TO
SEWER OR SEPTIC TANK

-No Digging Up Floors-

INSTALLS EASY. ANYWHERE!

Write McPHERSON, Inc., Dept. E

Box 15133 Tampa, Florida 33684

UNIQUE SILK-SCREENED GLASS PLAQUE



Along The Way... Take Time to Smell The Flowers—declares this beautifully colored glass plaque. Adds visual effect to any mantel, window or table top. Panels fold flat to 5"x7". Perfect gift for a special person. Satisfaction Guaranteed!!

ONLY \$8.98 Add 45¢ postage or 2 for \$16.95 ppd. No duty or tax on U.S. orders. Send check or money order to:

INEXCO ENTERPRISES
Dept. K1, 92 Ewen Rd., Hamilton, Ontario,
Canada L8S-3C5

ENGLAND—stay as a welcome houseguest for 1, 3 or 7 nights in Manor Houses or olde worlde country homes in Royal Windsor, Kent or Bath. Home Hospitality will match up families and help you meet your British counterpart to ensure your stay is memorable. Home Hospitality, 11A Chapel Street, London, N.W. 1, Tel. 01-402-2178.

* HEARING AIDS *

From \$89.50—30 Day Trial
GIGANTIC SAVINGS ON BATTERIES

Write For Free Gift Offer
and Brochure Today

ELECTRONIC PRODUCTS

Box 2005-E, Pinellas Park, Florida 33565

Horror

(Continued from page 31)

The Exorcist spawned a terrible torrent of films depicting children as monsters of one kind or another. There was *The Omen*, written by David Seltzer with inspiration from the Book of Revelation. On little Damien's fifth birthday, the child suddenly and eerily glances at a ferocious dog, who in turn glances at the boy's nanny. Then you see the nanny hanging herself from the roof of the stately mansion. Soon the parents realize they have the son of Satan himself on their hands. *The Omen* was also a tremendous hit.

It's Alive concerned a murderous newborn infant who, after dispatching the nurses and doctors in the delivery room, crawls around Los Angeles at will, killing milkmen, senior citizens and other innocent adults.

Without question, the horror movie has replaced the Western as Hollywood's surefire bread-and-butter draw. The horrors are the staples of the drive-ins and neighborhood theaters. Peopled with monsters, murder and mayhem and terrible tots, horror pictures are laughable to most adults but thrilling to kids and teenagers. Hollywood moviemakers, literally scared half to death by television, forsaken art and message pictures and turned to horror, suspense and monsters to fill their moribund theaters. A whole new generation has discovered movie terror and fallen in love with monsters, things, creatures, super beasts, vampires, bats, saucer-men, fiends, mutants, humanoids, batmen, catwomen and teenage werewolves.

Led by a handful of low-budget producers, Hollywood is cashing in. And the big studios are joining the parade to the bank. Every major studio has produced horror movies and has more on its schedule.

You won't find any Academy Award material there, but they all are gassers in the blue jeans and ponytail set. The titles are often more interesting than the movies and arouse much comment from worried parents and PTA groups. They complain that the pictures of terror and horror have a disturbing influence on children and may possibly incite teenagers to violence. To which the producers and theatermen retort: "Nonsense."

"The horror films are fantasy—sort of grown-up fairy tales—and no worse than the witches and goblins of childhood fables," one producer protested. "We invite protesting PTA groups to review our films, and they often come away embarrassed over the fuss they

(Continued on page 39)

FUND RAISERS

Make Your Next Social A Profitable Success!



- THOROUGHBRED RACING
- HARNESS RACING
- GREYHOUND RACING

Whether it's Thoroughbred, Harness or Greyhound racing, A NITE AT THE RACES® offers the most unique "fun" and fund-raising program in popular use today.

A complete 16mm film package of actual races in vivid color with authentic track sounds and commentary also includes official programs, mutuel tickets, play money, computation forms and daily doubles. Exactas and quinellas available. **PAST PERFORMANCES** and **MIXED FORMAT RACING KITS** are also heavy favorites with A NITE AT THE RACES.®

Write today for free brochure or call us "COLLECT" now!

a nite at the races, inc.

2320 Ave. "U" • Brooklyn, N.Y. 11229

Tel: 0-(212) 769-7355

\$300 a Week ... Now I'm a FULL TIME LOCKSMITH

"Because of a disability, I needed work that didn't require much physical effort. I investigated Belsaw, and now I'm working full time earning as much as \$300 in a week."

Tom Tipton - Covington, Georgia

Make up to \$10 an Hour—Even While Learning! Send for facts! Don't let age, education or a handicap stand in your way. Be your own boss in a business of your own. Learn at home in spare time. All equipment and supplies furnished. Special tools, picks and a pro Key Machine are yours to keep. Send for facts. Accredited Member NHSC.

No Obligation...No Salesman Will Call

FREE BOOK BELSAW INSTITUTE

130T Field Bldg., Kansas City, Mo. 64111

Please rush FREE Book "Keys to your Future."

NAME _____
ADDRESS _____
CITY STATE ZIP _____

full details! RUSH COUPON TODAY!

PROSTATE RELIEF

Banish prostate misery! Relieve problems like pain, dribbling, urgency, retention, and getting up nights. Send now for FREE report! Relief, Dept. EK-2, Box 23181, Wash., DC 20024

FREE REPORT
Rush FREE report on prostate relief

Name _____ Age _____
Address _____
City _____ St _____ Zip _____
Relief, Dept. EK-2, Box 23181, Wash., DC 20024

Let Belsaw prove **YOU** can
Earn Up To
\$800 an
Hour



In
YOUR
OWN
SPARE
TIME or
FULLTIME

SHARPENING BUSINESS!

On our
30-DAY
FREE
TRIAL
OFFER

You risk nothing by accepting this offer to see how easily you can turn your spare time into big Cash Profits with your own Complete Sharpening Shop. No selling . . . no previous experience needed. Our famous Sharp-All and show-how instruction set you up to make \$200, \$500, \$700 a month CASH sharpening Saws, Knives, Scissors, Lawnmowers, Shop and Garden Tools . . . all cutting edges.



LIFETIME SECURITY
with **YOUR OWN BUSINESS**

FREE BOOK!
Gives Full Details

Send for all the facts!
Our Free Book tells how to start a profitable, lifetime home sharpening business, how we help you grow, how we'll finance you.

Send for FREE details—mail coupon below or postcard TODAY!
BELSAW SHARP-ALL CO., 6056 Field Bldg., Kansas City, Mo. 64111

No Obligation... No Salesman Will Call

YES, **BELSAW, 6056 Field Bldg., Kansas City, Mo. 64111**
please send me the **FREE BOOK** that gives full details.

Name _____ Please Print _____
Address _____
City-State _____ Zip _____

BINGO



Largest Manufacturer and Distributor of BINGO Supplies

Free Catalogues available for:

- ★ Complete bingo supplies
- ★ Tables & chairs
- ★ Flags & banners
- ★ Armchair races
- ★ Jar & breakopen tickets

ALL STAR BINGO INC. Dept. E-10
P.O. Box 346, Rockville Centre, N.Y. 11571
Toll Free Call: 800-221-6706

MEN'S WIDE SHOES

EE to EEEEE • Sizes 5 to 13

More than 100 styles for every purpose. Top quality. Sensible prices. Not sold in stores. Send for FREE CATALOG.



HITCHCOCK SHOES, INC.
Dept. 11J, Hingham, MA 02043

" DO YOU BURN WOOD? "
AVOID DISASTER!

Our new illustrated 112-pg book clearly shows safe, simple and effective ways to clean dirty chimneys and stoves—**major cause of house fires!** NOW is the season to do it. Send only \$4.95 plus 60¢ postage. Ask for Chimney Book.

GARDEN WAY PUBLISHING CO.
Box 90120, Charlotte, VT 05445

IT'S YOUR BUSINESS

by John C. Behrens

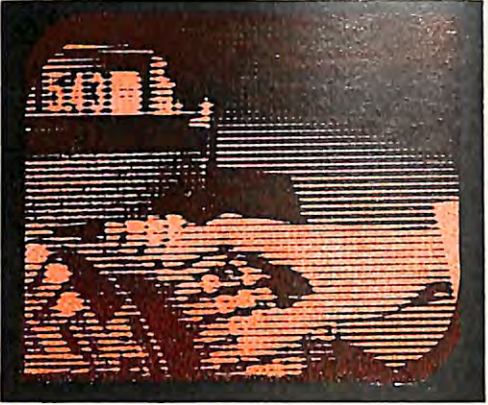

YANKEE INGENUITY

While American consumers and businesspeople worry about the recession that government officials keep insisting we can avoid, a group of New England businessmen and administrators are demonstrating that good old Yankee ingenuity is alive and well.

Two years ago next month, the Small Business Export Program, which represents a coalition of the Smaller Business Association of New England and the Massachusetts Port Authority, sent its first trade mission to western Europe. The purpose? To encourage and develop foreign markets for the small firms in the New England region.

The ramifications are significant. Other areas of the country, hard-pressed during this unofficial slow-down or simply ambitious to enlarge their economic base, could follow such a plan in the years ahead. It offers new markets to businesses in coastal areas that are generally remote from international trade or simply unable to compete with giant corporations and multinationals.

Inland communities with transportation capabilities could also find help with such a plan.

The Massachusetts experiment was the first of its kind in the nation, according to David W. Davis, executive director of the Massachusetts Port Authority. He describes it as a "unique international marketing program" which attempts to assist the Commonwealth's small enterprises—manufacturing particularly—which lack the resources and time to explore overseas outlets or develop markets for their goods.

The Port Authority, called Massport, operates Boston's Logan International Airport, Hanscom Field and the Port of Boston General Cargo Marine Terminals, and utilizes its own marketing staff and trade office in Belgium to service the export program.

In conjunction with the Smaller Business Association, Massport provides other inducements, too. For example, it offers representatives of selected companies money to cover the cost of one-half of the round trip economy air fare, \$100 per day for hotel, meals and ground transportation and up to \$200 for miscellaneous expenses such as translation and secretarial work. The costs can be paid back over a 12-to-18 month period.

Davis believes that the return on such

an investment is simply good business for all parties, including Massport. It offers a stimulus for potential business and jobs in Massachusetts, and the prospect that such activity will increase trade for the airport and the marine terminals.

In a two-year period, Massport received about 1,500 inquiries about the program and more than 700 applications. It was so successful, in fact, that it was enlarged. "Based on the bottom line to date, we decided to expand the program to include all of New England," Davis added. Manufacturers from Vermont and Rhode Island have joined Massachusetts' firms in seeking markets in Europe. 25 companies had participated by the time Massport issued its first report in March, 1979.

"Results to date have produced actual sales of \$1,224,000 to companies met directly or indirectly during the trade mission. 18 foreign distributors have been signed and 11 European companies have come to the states to pursue discussions and negotiations with participating companies," Massport reported. A total of 104 individual meetings have been held in 11 countries in 24 months.

Massport Boston uses its overseas office to research and analyze a variety of factors before a trade mission country is selected. Among the elements frequently reviewed are trade balance with the U.S. and world markets, nature of the economy, wage rate, labor situation, currency market and status, tariffs, quotas restrictions, repatriation of U.S. money, political stability, shipping service to Boston, membership in trade associations, customs unions and trade incentives offered by the U.S. or the country for doing business in that market.

Furthermore, the completion of the visit abroad doesn't terminate the program for the company or Massport. Follow-up can be as important as the meetings.

Unlike so many bureaucratic programs, Massport's efforts appear to speak for themselves. According to Davis, 17 Massachusetts firms participated in three trade missions by January, 1979, for instance. The missions generated \$706,158 in actual export sales. An additional \$3.5 million is forecast for the current 12 months.

Best of all, most businessmen say, there is no charge for the service.

Horror

(Continued from page 37)

have stirred up. The kids know that the monsters and horrors are make-believe. Their fright is often tinged with amusement. 'It's fun to be scary' is the way the kids put it."

In this the producers are backed up by most psychiatrists and child psychologists. Dr. Martin Grotjahn of the University of Southern California, a psychiatrist often called as an expert witness at criminal trials, believes horror films may be good for youngsters.

"Fright films can be helpful to teenagers," he says. "Some childhood anxieties never die—fears of witches, ghosts and things that are sinister and mysterious. These things stay with the adolescent. There are three ways to overcome these anxieties—psychoanalysis, nightmares and horror movies. Since a teenager associates himself with the movie, he finds therapy in the happy ending or in the return to reality when he leaves the theater."

History gives us many examples of the fear phenomenon. Just as children today still find special delight in gathering around the campfire for a session of ghost stories, the activity has fascinated generations of adults.

One theory holds that too many real horrors in the 20th century exist for us to cast our fright lot with ghosts and other unnatural phenomena. Today we have the Bomb, man's inhumanity to man, and countless day-to-day problems.

"We feel a need to handle our fears," says Chaytor Mason. "We ride roller coasters, peer at traffic accidents on the freeway and attend monster and Alfred Hitchcock movies. We live in a world of intrigue, power and threats. And, subconsciously, we want to come to grips with it, to conquer our fear of the known rather than the unknown."

What's next on the Hollywood horror horizon? Plenty. There will be a *Dracula II* and a *Superman II*. *Superman* wasn't exactly a horror picture, but there were many moments when members of the audience were gripping their seats. The earthquake that demolished the planet *Crypton* and the earthquake that rocked California were terrifying to watch, as they were planned to be, of course.

American International Pictures plans plenty more horror films, most of them yet unnamed. But one of them will be *Meteor*, which studio officials feel will be a real blockbuster.

Irwin Allen, the industry's disaster expert, is readying a film called *The Day the World Ended*. Of course the title is a bit of a fraud. It doesn't really end; you knew that, didn't you? ■

Money isn't the only reason to start your own business



A lot of people start their own business for the pure satisfaction of it. Being your own boss. Making your own decisions. Establishing your own lifestyle.

If you too want the satisfaction of your own business, consider General Business Services.

GBS is one of the nation's leading small business counseling firms, with franchises in every state. We've started nearly 1000 career-minded men and women on the road to their own business counseling practices.

And we can help you get started, too.

As an independent GBS counselor, you'll work with other businessmen and women—right in your own community—providing the professional recordkeeping and management services almost every small business needs.

An investment of \$15,000 covers complete training, supplies, and the full technical support of our large national office staff. Even if you've never had formal training in business or accounting before, the time-proven GBS system can make you your own boss in just a matter of weeks.

Use the coupon below to find out more about the rewarding career opportunity GBS offers you.

©1979, General Business Service, Inc.

Please send me your free brochure, "An Investment in Yourself and Your Future," about a GBS career.

Name _____

Address _____

City _____ State _____ Zip _____

Phone _____

GBS

Robert Turner, Vice President
General Business Services, Inc.
 Department EM-U-10
 51 Monroe Street, Rockville,
 Maryland 20850

Bargain Price . . . Plus Our Famous 72-Hour Service!

TULIP BULBS

only **4¢** each

MINIMUM 50 FOR ONLY \$2.00

Tulips bloom in all their graceful splendor and brilliant color in spring . . . but they must be planted in fall! Mail coupon today for this fantastically low-priced bargain offer. Our "flaming mix" assortment of healthy, hardy planting stock bulbs (2 1/4-3" circ.), bloom year after year without replanting, 50 for only \$2.00. Or order 100 for only \$3.50 and really save! Add 40c postage and handling. We guarantee to ship your order within 72 hours after we receive it! Better yet, you get six beautiful Crocus free with every order received by November 1. Given proper soil, care and with normal growing conditions, these tulips should develop into larger size bulbs the first year's planting. In fact, we guarantee many blooms next spring, normal bloom the second season and at least 3 years thereafter or free replacement. If not satisfied on arrival, return within 15 days for full refund. Clip and mail today.



**FREE
6 CROCUS**

at no extra cost with every order received by Nov. 1. (2 3/4" circ.). Imported Holland. Mixed Colors, bloom every spring.

**10 DAFFODILS
ONLY \$1.50**

Another tremendous bargain! NARCISSUS variety (avg. 4" circ.), mixed colors. Use coupon at right, send today.

(Add 40c postage and handling)

**MICHIGAN BULB CO., Dept. R-51
1950 Waldorf, Grand Rapids, Mich. 49550**

Please rush my order as checked below within 72 hours of receipt. Guarantee of satisfaction on arrival or I may return within 15 days for full refund. Remittance enclosed, (sorry, no COD's . . . Post Office Charges almost \$1.00 extra). Print name and address below.

50 Tulips, \$2.00

10 Daffodils, \$1.50

100 Tulips, \$3.50

20 Daffodils, \$2.95

200 Tulips, \$6.50

40 Daffodils, \$5.75

Print Name _____ Address _____

City _____ State _____ Zip _____

NEWS OF THE STATE ASSOCIATIONS

The golden anniversary of the New Mexico Elks Association was held in Albuquerque. Outgoing SP Greeley Myers presided over the April 19-21 conclave. Guest dignitaries who joined the 628 conventioners were then-GER Leonard and Ginny Bristol, PGER Robert Boney, and Dot and Howard Nunez, chairman of the GL Committee on Credentials. The dignitaries joined New Mexico Brothers in congratulating Past GL Committeeman and Major Projects Chm. Jerry Gorman for his receipt of the Elk of the Year Award.

Many awards were proffered to lodges and members for various accomplishments of the past year. Winners of the Best Lodge Contest were Carlsbad Lodge, which received the first-place PSP William J. Bingham Memorial Trophy, Albuquerque Lodge, which won the second-place William John Bindel II Memorial Trophy, and Las Vegas Brothers, who received the third-place Hursh-Kearns Memorial Trophy. District awards were earned by Rio Rancho, Gallup, Roswell, and Las Cruces lodges.

PER Kenneth Littell of Albuquerque Lodge was champion of the PER Flag Charge Contest, and Albuquerque's PER Edward Wood received a plaque of recognition for his work over the past two years as ritualistic chairman. PER Sam Van Atta of Grants-Milan Lodge was honored with the President Myers Special Award for his service to the National Foundation. Carlsbad, Silver City, Artesia, and Farmington lodges received awards for the deer hide drive, Artesia Lodge won the PSP Ray Camp Special Award, and the PGER Horace Wisely Traveling Trophy for membership gain was earned by Grants-Milan Brothers. National Foundation honors were bestowed on Grants-Milan, Gallup, and Roswell lodges. The Robert E. Boney Award for most consistent participation in all the state programs went to Carlsbad Lodge. Silver City, Raton, and Santa Fe lodges were honored for their outstanding contributions to the Cerebral Palsy Drive.

The business proceedings included PGER Robert Boney's announcement of the District Deputy Grand Exalted Ruler appointments. State officers elected for the 1979-1980 lodge year were SP Willis Claus, Albuquerque; Vice Presidents Earl Phillips Jr., Roswell; Stuart Rucker, Gallup; Secy. Howard Nunez, Albuquerque; and Treas. E. H.



Dignitaries who attended the New Mexico Elks Association Convention included (from left) Howard Nunez, chairman of the GL Committee on Credentials, PGER Robert Boney, then-GER Leonard Bristol, and outgoing SP Greeley Myers.

Jahraus, Farmington. New Mexico Elks will meet at Carlsbad for their fall meeting, and Farmington was selected as the location for next year's April 17-19 state convention.

More than 200 delegates attended the Utah Elks Association Convention held May 18-19 in Price. During the conclave, Marcie Beck, national Most Valuable Student, addressed the conventioners. She was sponsored by Cottonwood (Murray) Lodge and will receive a \$12,000 scholarship.

Among the other highlights of the state meeting was the recognition of Park City and Provo lodges for their contributions to the National Foundation. The Memorial Day Award was earned by Ogden Lodge, a Flag Day citation was awarded to Bountiful Lodge, Provo Lodge received the Visitations Award, and Hides for Veterans awards were proffered to Price and Park City lodges. PER John Callahan of Ogden Lodge was named Elk of the Year, and ER Leonard Kelly of Provo Lodge won the Eleven O'Clock Toast competition.

The decisions arrived at during the convention proceedings included the unanimous approval of the budget for this coming year. The board of trustees proposed to set the budget at \$45,916. SDGER Alton Thompson spoke to the assembly concerning support of the Conference of Private Organizations.

Utah Brothers congratulated their new SP, William Buckingham of Tooele Lodge. Brother Buckingham's fellow state officers are Vice Presidents Dennis McGuire, Cottonwood (Murray);

Dan Wright, Park City; W. F. Robirts, Price; Secy. John Paulos, Tooele; and Treas. Harry Ellis Johnson, Ogden. The Brothers will conclude their terms of office in the spring of 1980 when Utah Elks convene for the May 16-18 convention hosted by St. George "Dixie" Lodge.

Scholarships worth \$500 each were awarded to four students during the Kentucky Elks Association Convention held May 24-26. The "Hoop Shoot" program benefitted from a contribution of \$3,600 made by the Kentucky Brothers, who also raised \$7,000 for their state major project, aid to the cerebral palsied. Princeton Lodge hosted the state conclave held at the Ken Bar Resort in Gilbertsville.

Elected to the post of State President for the 1979-1980 lodge year was Eugene Butters of Princeton Lodge. Brother Butters's assisting officers are President-Elect Joe Pat Gaines, Frankfort; Vice Presidents Ozell Haile, Hopkinsville; Ray Freeman, Ashland; Robert Bickett, St. Matthews (Louisville); and Secy.-Treas. Garland Guilfoyle, Newport. The officers were congratulated by 210 people in attendance, including then-GER Leonard and Ginny Bristol, PGER Edward and Maggie McCabe, Nell and Ted Callicott, member of the GL Ritualistic Committee, and Dottie and Donald Nemitz, member of the Grand Forum. A dinner-dance was held in honor of the SP and the national dignitaries.

Three teams participated in the ritualistic contest, the winner of which was the Louisville Lodge team. Second



PGERs George Klein (left) and Homer Huhn, Jr. (right) joined T. J. Plummer Sr. in congratulating his son incoming SP Tom Plummer Jr. (second from left) upon his receipt of a National Foundation certificate during the Nebraska conclave.



PGER Francis Smith (second from left) and incoming SP Richard Pillar (left) offered their congratulations to Past GL Committeeman L. J. Gregory (second from right), who was chosen Elk of the Year at the South Dakota Elks Association Convention. Outgoing SP Charles Gaeckle (right) presented the award to the honored Brother, who was a major force in the establishment of the major projects trust fund.

place was captured by Newport Lodge, and third place went to Madisonville Lodge. Fifty participants competed in a golf tournament. Trophies were presented to the champions during the Saturday night banquet.

Kentucky Elks will gather in Ashland on November 2 and 3 for the semi-annual meeting. Covington was selected as the location for next year's May 29-31 conclave.

The Exalted Ruler's March took place during the Nebraska Elks Association Convention hosted by Ogallala Lodge. Over \$3,600 was presented by the officers for the benevolence program. Special guests who witnessed the procession included PGER Homer and Jo Huhn, Jr., PGER George and Ruth Klein, and then-Grand Est. Lect. Kt. Chester and Helen Marshall.

Leading Nebraska Brothers in the business of the state association for the new lodge year will be SP Tom Plummer Jr. of Ogallala Lodge. Brother Plummer's assisting officers are Vice Presidents George Johnson, Fairbury; Gaylord Nielsen, Grand Island; Kenneth Green, Scottsbluff; Secy. Chester Marshall, Kearney; and Treas. Bob Burkley, Fairbury. The new officers will conclude their terms at Omaha, where next year's May 16-18 state convention will be held. A fall conference hosted by Kearney Lodge precedes the spring convention.

PER Jack Pollock of Ogallala Lodge was the speaker for the memorial service performed by Holdrege Lodge and observed by the 700 conventioners. During the service, special recognition was given to the late Past Grand Est. Lect. Kt. W. K. Swanson. Recognition of all the PERs who died during the past year is a new section

of the service put into practice at the convention.

For the third consecutive year, Kearney Brothers won the ritualistic contest and retired the H. L. Blackledge Trophy. Ed Coover of Scottsbluff Lodge captured the Dr. William E. Nutzman Trophy for earning the most points in the contest, and PER Richard Friend of Hastings Lodge was champion of the Eleven O'clock Toast Contest. The George Klein Award for Ritualistic Coach of the Year went to PDD William Lechner.

Over 200 people attended a luncheon for PERs and their wives, where an auction was held to raise funds for the PER scholarships. Two students received PER scholarships, and the J. B. Ferguson Golf Scholarship was also presented during the convention proceedings. An additional luncheon was held for the other officers and their wives.

The highlight of the conclave was a Saturday evening banquet attended by over 700 people. Steaks grilled outdoors were served western style, and music was provided by the Swing Choir from Ogallala High School. During the banquet, PGER Homer Huhn, Jr. addressed the assembly. The speaker for Sunday's business session was PGER George Klein. Kearney Brothers honored then-Grand Est. Lect. Kt. Chester Marshall with the presentation of a specially designed ring, and Helen Marshall also received a gift.

PGER Francis Smith was the special guest of the 70th annual South Dakota Elks Association Convention hosted by Aberdeen Lodge. PGER Smith offered his congratulations to Elk of the Year and Past GL Committeeman L. J. Gregory, who has been an Elk for 50 years.

Over 300 people registered for the June 7-9 conclave. The highlight of the meeting was the installation of the state officers. Brothers elected to the state positions are SP Richard Pillar, Yankton; President-Elect Elroy Robish, Brookings; Vice Presidents Ronald Peterka, Watertown; Carroll Hendricks, Madison; DeWayne Borszich, Rapid City; Vice President-at-large Charles Gaeckle, Madison; Secy. Wayne Shenkle, Sioux Falls; and Treas. Joseph Garrity, Brookings.

Scholarships were presented to ten youngsters during the convention. Chm. John Lang announced the recipients, and outgoing SP Charles Gaeckle presented the awards to the honored students. Reports given during the proceedings indicated that although there was a decrease in membership over the past year, National Foundation contributions increased to surpass the national goal of donations per lodge. South Dakota Brothers raised \$97,663.17 for charitable endeavors.

A fall meeting includes a ritualistic clinic and a workshop for committee members. The 71st state convention will be hosted by Sioux Falls Brothers from June 5 through the 7th.

The goals discussed by Missouri Brothers during their April 6-8 state convention included the establishment of one new lodge in each of the six districts, greater participation in ritualistic contests, and expansion of the state softball tournament. The Brothers also considered changing the convention registration procedure and adopted several alterations in the state association bylaws. DeSoto Lodge's contribution to the National Foundation set a

(Continued on next page)

NEVER BUY GAS AGAIN!



CALL FREE
800-257-7955



ELECTRIFY YOUR BIKE!

PEDALPOWER exciting new bike drive tames tough hills. Be independent. Shop when you want. Fits all Bikes, Adult Trikes. Installs in minutes. Thousands sold. Recharges overnight. Travels 100 miles for a dime. **MONEY BACK GUARANTEE**

Call toll free: 800-257-7955*
Or send today for

FREE ILLUSTRATED BOOKLET

General Engines Co.
5464 Mantua Blvd.
Sewell, N.J. 08080

DEALER INQUIRIES INVITED

*In N.J., Alaska, or HI. Call Collect: (609) 468-0270

Put Your Fund-Raising Program in the Winner's Circle

CINEMA RACES is a fascinating fund-raising formula used successfully by organizations throughout the U.S.A. The **CINEMA RACES** complete package includes: Authentic full-color-and-sound 16mm horserace films, programs, tickets, play money and easy-to-follow instructions. **CINEMA RACES** will make the most rewarding Game Night you've ever sponsored. Call or write for details.

CINEMA RACES

Dept. E8

A General Instrument Company
383 Hillen Rd. / Towson, Md. 21204
301-321-8166



ENGLISH COUNTRY SPORTING WEEK-ENDS

This Autumn and Winter Home Hospitality can offer limited unsurpassed accommodation in a family Ancestral Home in Lincolnshire, with visits to Bloodstock Sales, Horse Races, Hunting and Shooting Meetings. Experience the best of English food and sport in this exclusive environment. For further details of this unique opportunity please write to: Mrs. Serena Smith,

HOME HOSPITALITY

11A Chapel Street, London, N.W.1. Telex MAJMIN 261852, who has been appointed agent by your Host and Hostess.

HYDRAULIC JACK REPAIRS

Earn While You Learn In Your Spare Time

Trained and qualified mechanics needed NOW to service inoperative hydraulic jacks. BIG opportunity for ambitious men. We show you HOW - in your basement or garage to earn spare time cash in an expanding industry. Don't wait, ACT NOW! Get the facts.

Write for folder E10 and free bonus offer

Hydraulic Jack Repair Manual Co., Inc.
P. O. BOX 3 • STATEN ISLAND, N. Y. 10314



News Of The State Associations

record of \$22 per member, which was celebrated as one of the past year's accomplishments.

There were 520 conventioners registered for the meeting held at Cape Girardeau. Special attendants were PGER Edward and Maggie McCabe, then-GER Leonard and Ginny Bristol, Norvel and Daniel Tammany, then-member of the GL Committee on Judiciary, Dorothy and PSP Galen Marr, then-member of the GL Committee on Credentials, Dottie and Vets Chm. Donald Nemitz, member of the Grand Forum, SDGER and VP Bernard Watters, and SDGER Paul and Helen Sibley. PGER McCabe and then-GER Bristol addressed the Missouri Brothers.

Trophies were awarded to Washington Lodge for earning first place in the ritualistic contest and to High Ridge Lodge for winning second place. Winners of the bowling tournament were announced, and plans for the Blue Springs Golf tournament were discussed. Commendation was given to SDGER and New Lodge Chm. Paul Sibley for his direction of the institution of eight new lodges. Dispensation for the establishment of Missouri's 50th lodge, at Lake Taneycomo, was granted. The annual Mystery Elk Awards were presented to PER Gary Mabrey of Cape Girardeau Lodge, Past GL Committeeman W. H. Stewart O'Brien, and Brother Gene Corey of DeSoto Lodge.

Conventioners observed the memorial service presented by PDD and Chm. R. O. Slaughter, PER Ken Worley of Joplin Lodge, GL Committeeman Galen Marr, PDD Donald Conrad, and Past GL Committeeman W. H. Stewart O'Brien. They also enjoyed a banquet and a brunch, and the Elks' ladies viewed a fashion show during the luncheon. Saturday's banquet was also the occasion for the receipt of \$3,000 in random gifts to the major project, support of five mobile dental units which serve handicapped children. The Missouri Elks Benevolent Trust had met that day to discuss the major project.

Newly elected officers for the 1979-1980 lodge year are SP Edward Mullen, Jefferson City; Vice Presidents Roy Welshon, DeSoto; Bernard Watters, Kansas City; Donald Reinhart, Grandview-Hickman Mills; Robert Todd, Springfield; Edward Mueller, Cape Girardeau; R. Tom Hooley, Hannibal; Vice President-at-large Melvin Carpenter, Festus-Crystal City; Secy. Rep Breniesen, Jefferson City; and R. M. Frye, St. Joseph. Missouri Brothers will reconvene for a fall meeting at Columbia from September 21 through the 23rd. Jefferson City will host next year's April convention.



SAVE HUNDREDS OF DOLLARS

Possess the gem that's as brilliant as a diamond.

The incredible **MAGIC FIRE™** has more "fire" than a glittering natural diamond. Own the dazzling impact of diamonds that can easily sell for up to \$1,000 per carat — for a fraction of the cost. From \$35 — All settings in 14K Solid Gold. Send for our FREE catalog of pendants, earrings, and rings for men and women. Credit cards accepted.

MONEY BACK GUARANTEE

Easy Payment Plan Available

The Crown Collection Dept. EL-109
509 Madison Ave, NY, NY 10022

Amazing soft plastic cushion

holds dentures comfortably tight for weeks without messy "stickums"

Not a messy paste, powder, cream or wax pad—but an amazing soft plastic adhesive cushion. Snug® Brand Denture Cushions hold loose, wobbly dentures comfortably tight for weeks. With Snug there's no need to bother with messy daily "fixing." It lasts for weeks, sticks to your plate not to your gums, so easy to clean or remove. Get Snug Denture Cushions to hold your dentures tight and firm for weeks...in comfort. At all drug counters.

REMBRANDT DID IT IN OILS...

Let us do it in BRONZE PLAQUES

FOR ALL OCCASIONS

Write for Free Catalog E23
Engraved Plaques E21

INTERNATIONAL BRONZE TABLET CO., INC.
150 W. 22nd St., N.Y., N.Y. 10011 212-WA 4-2323



AT LAST! YOU CAN BE AN AUTHORITY ON HISTORY

Send \$1.00 (refundable on first purchase) for catalog of historically accurate:

Miniature Soldiers & Cannons in Pewter
Uniform Prints & Post Cards

Mail today to:
Professional Information
Box 566, Dept. E
Spring Lake, N.J. 07762



JOKES FOR SPEAKERS!

Topical Joke-Bulletin with approx. 100 funny one-liners, stories and roast-lines. Created by top Hollywood comedy writers. Ideal for Business and Club meetings, Banquets, etc. Humorize your speech for any audience, any occasion. Current issue, \$5.95. Send check or m.o. to:

JOKES UN-LTD.

1357 Miller Dr. Dept. E-9, Hollywood, Calif. 90069

RUPTURE AGONY

DISAPPEARS.....

WHEN you slip into a Brooks Appliance! Your reducible rupture will be held firmly, yet gently, night and day, at work or play. Send for our FREE illustrated booklet. **BROOKS CO., Box 370-B, Marshall, Mich. 49068**



Crucial Issues

(Continued from page 17)

money. Real economic growth requires a low rate of inflation which can only be controlled by monetary and fiscal policy. A balanced budget and a very slow growth in the supply of money are two requirements."

"We're imposing very severe limits on government spending and we are pursuing a tight fiscal policy, and I believe that the President will achieve a balanced budget by 1981 which, parenthetically, is a promise he made in his campaign," former Treasury Secretary W. Michael Blumenthal reported before the 1980 budget was prepared. The last balanced budget was in 1969, when there was a surplus of \$3.2 million.

"There's been an abysmal performance in productivity. We're not increasing our productivity and that's been a factor which prevents us from absorbing inflationary shock. Thus, we're following a policy dedicated to business incentives. We're freeing the country as quickly as possible from the excessive regulatory restraints that are holding down the productivity of the American economy," Blumenthal explained.

Uniservice chief executive Roden has doubts, though. "Up until now we have been controlled by the various states and it has worked pretty well, but there is increasing pressure for federal controls because of real and alleged abuses. I would like to see some sense made of our bureaucracy so that we are not inundated with incomprehensible and often conflicting regulations, forms, filing requirements, etc. But this would seem to be a futile hope, given our history."

What about the country's monetary policies for the 1980s?

The 1970s, some analysts say, were not a good time for Americans or their money. The dollar, once as good as gold, eroded in a country which still houses one of the largest gold reserves in the world. Official world gold reserves are estimated at better than one billion ounces. The United States, the same sources report, holds about 250 million ounces of the world total.

While the pessimists insist that further devaluation and hyper-inflation are still ahead, Jerome Tuccille, a former *Wall Street Journal* staffer, broker and candidate for governor of New York, maintains that the worst is behind us. In his book, *The Optimist's Guide to Making Money in the 1980s*, Tuccille claims that "Within the next few years, the U.S. dollar should bottom out, then begin a slow, steady comeback in the financial markets." ■

Make \$800 An Hour and MORE Sparetime or Fulltime

Sharpen Saws and other tools in Profitable Business of Your Own Be Your Own Boss!!

Turn your spare hours in the evening or weekends into extra dollars, this proven practical way—start your own money-making sharpening business—No selling or canvassing—No experience required.

You quickly learn how to sharpen these valuable tools and many others. Excellent profits! We show you how to set up a business and keep it running profitably. Part time or full time. No special skills needed.



FREE BOOK Send coupon and you'll receive, at no obligation, a booklet that describes in detail, the opportunities available to a person who owns his own saw and tool sharpening business.

There is **NO** Obligation



MANUFACTURING COMPANY
1835 Foley Building
Minneapolis, Minnesota 55418

Please send me the free booklet "Opportunities In A Sharpening Business Of Your Own."

Name _____
Address _____ Phone _____
City _____ State _____ Zip _____

FOLEY MANUFACTURING CO.
1835 Foley Building
Minneapolis, Minnesota 55418
Send Coupon Today or CALL TOLL FREE 1-800-328-7140
Except Hawaii or Alaska

RETIRE IN FLORIDA'S

FINEST MOBILE HOME COMMUNITY

From only \$24,900 on Florida's Atlantic Coast there is beautiful lake country where you can retire on a sensible budget in an adult community of doublewide mobile homes.

Phone toll free 1-800/237-9494 for more information on how to get full enjoyment out of Florida retirement living. Or fill out the coupon. →

VILLAGE GREEN

at Vero Beach / A Lakefront Community of Distinctive Mobile Homes



MAIL TO: VILLAGE GREEN
Dept. 3703 P.O. Box 6037
Vero Beach, FL. 32960.

Name _____
Address _____
City _____
State _____ Zip _____
Phone _____

FIND BURIED TREASURE

Find buried gold, silver, coins, treasures with powerful new electronic detector. Ultra sensitive. Penetrates deep into earth. Works through mud, beach sand, rock, wood, etc. Signals when object is detected.



Write for Free Catalog

RELCO Dept. DD29. Box 10839, Houston, Tex. 77018

CAREYES, MEXICO:

Treasure of the Sierra Madre

by Jerry Hulse

There is this new place in Mexico, Careyes, and it reminds me of Hawaii before so many high rises crowded its beaches. It is difficult to get excited about a new resort these days. So many tend to resemble the one you just left or the one you are going to—but not Careyes. It is a gem cut into the shoreline between Manzanilla and Puerto Vallarta. Remember this date-line, for one day soon it will be as widely known as Acapulco.

Like Hawaii, the land is choked with palms. There is the beauty of Kauai with beaches like those on Maui. But there the similarity ends; Careyes is not overrun by tourists. Not yet, anyway. Presently, there is but one hotel, the delightfully Mediterranean-styled Plaza Careyes. It is a hotel unlike any other in Mexico—or anywhere else, for that matter. Crescent-shaped, it resembles a small hill-town village strung along the shores of the Mediterranean. It is to be the heart of a planned pueblo, and it is not by accident that it provides this old world flavor, for the mastermind of Plaza Careyes is an Italian banker, Gian Franco Brignone.

Soon, the land on either side—running for 13 miles—will flourish with hotels, restaurants, shops and condominiums. But Brignone promises not to be greedy. He insists that only four percent of the land will be developed. The rest will remain a *green belt*. In the beginning, Brignone explored the Costa de Careyes by horseback. It was difficult, for Careyes is choked by jungle. Strange bird noises are heard at night and wild animals seek refuge in the thickets. Careyes is the treasure of the Sierra Madre. Only with the introduction of the new Pan American Highway did it become accessible to outsiders.

Brignone, gray-haired and affable,



represents a Mexican-European consortium that intends to finance the construction of dozens of hotels, hundreds of condominiums and scores of privately-owned villas. But again, using only four percent of the land. Already, Careyes is taking on the flavor of a European Riviera. Villas built by Italian, French and Swiss entrepreneurs are appearing along the hillside. Brignone led several of us on a tour beyond the new hotel. His land rover followed a path that twisted among mango, papaya and coconut trees. Stopping on a ledge that overlooked the sea, he pointed to one beach that runs for two-and-a-half miles. It will

support five hotels, and behind it, private homes will rise on the fairways of a championship-sized, 18-hole golf course. Elsewhere along the coast, a marina village is to be created. Presently, workers are assembling to dredge the land for canals and lagoons.

Such a project will provide hundreds of jobs. Brignone figures the population will rise from near zero to 20,000 within five years. Maybe sooner. He doffed his Australian outback-style hat and smiled hugely. Were those dollar signs we saw flashing in his eyes? Possibly. Still, he insists that this new coastal kingdom will never become another Acapulco. Hotels and condomin-

Palms fill the circular courtyard, bougainvillea climbs the ochre-colored walls and hibiscus crowds the garden of Plaza Careyes, a hotel designed to give the mood of age.

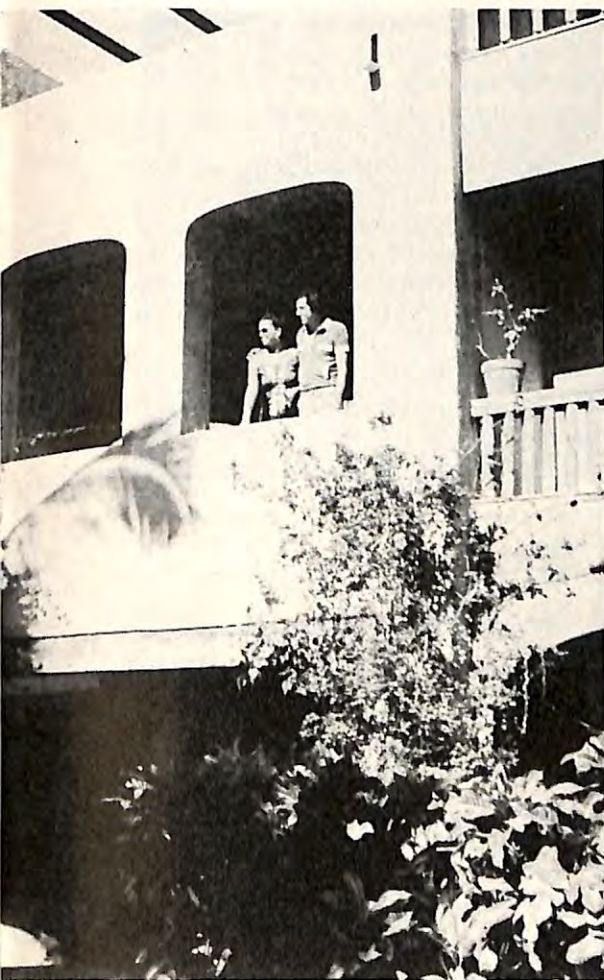

iums are to be limited to only three stories. Strict rules are being imposed. Thousands of lots are available for private homes, but no one can build helter-skelter. Styles must conform.

Along the coast there will be 32 zones. Each one is to have its own individual characteristics. The first condominium village will be built near the Plaza Careyes. Price tags will run from \$50,000 to \$100,000 per unit. Still others will bring as much as \$150,000 to \$180,000. Development of the entire 13 coastal miles will involve a period of 10 to 15 years. Brignone says that eventually there could be as many as 27 hotels. Or one to each half-

mile of shoreline. By Acapulco standards, this means the land will be next to deserted.

The grandson of the painter, Matisse, has built a villa near the Plaza Careyes. So has Brignone. His is perched at the very edge of the cliff. Straight down, 750 feet, the sea explodes against small, rocky islands. On the ocean side, his living room is without so much as a wall. The view is uninterrupted all the way to the horizon. It is a spot to be when the moon is full. Careyes has Club Mediterranee for its neighbor. But unlike other Club Meds, the village was created to blend with the land surrounding it. Careyes' first hotel, the Plaza Careyes, faces a beach of unsurpassed beauty. It is there by the sea that guests take their meals. Offshore 50 yards or so, the waves wash against two rocky sentinels. It is reminiscent of the better days of the Halekulani in Hawaii.

Palms fill the circular courtyard of Plaza Careyes, and guests look down from balconied apartments that seem as old as Seville itself. Although nearly new, the hotel was designed to give the mood of age. Bougainvillea climbs the ochre-colored walls and hibiscus crowds the garden. A single room with meals will cost you \$59 a day, plus gratuities (15 percent) and taxes (four percent). Doubles are available for \$90. And there are suites and apartments that bring as much as \$196 a day.

Careyes is unhurried. A sign in the lounge cautions: "Make taxi reservations 48 hours before departure." A cab from Manzanilla costs the passenger \$25, and the ride to Puerto Vallarta is a hefty \$50. But it is worth every twist and turn, for there is peace at Careyes. In the late afternoon, couples hike up to El Mirador, a hilltop lounge that overlooks the ocean. They go there to listen to classical recordings. Later, as the sun plunges beyond the horizon, the music reaches a thunderous crescendo. And those who watch... fill their souls with the scene.

Beach after beach lines the coast from Careyes. Forty-seven miles to the south lies Manzanilla. Puerto Vallarta is the nearest major attraction, though, and it lies 104 miles north of the new development of Careyes. It is an easy drive to Puerto Vallarta via a new highway. When we arrived the other day, it was raining in Puerto Vallarta. It was a soft afternoon rain and it did nothing to dampen the spirit. First of all, you don't come to Puerto Vallarta to complain about the weather. Nor do you take Puerto Vallarta too seriously; you just learn to live with it and enjoy it.

It's been this way for more than 100 years—ever since Guadalupe Sanchez settled his family here in 1851, right on the Cuale River. He was a wise man, this guy Sanchez. He chose a prime location. The river is where rich Americans came later to build their homes. So now they call it Gringo Gulch. Not far away there is a place called Daiquiri Dick's. This fellow Daiquiri Dick ran away to P.V., leaving behind a lucrative business in the San Francisco Bay Area to open the one here. His full name is Frederick

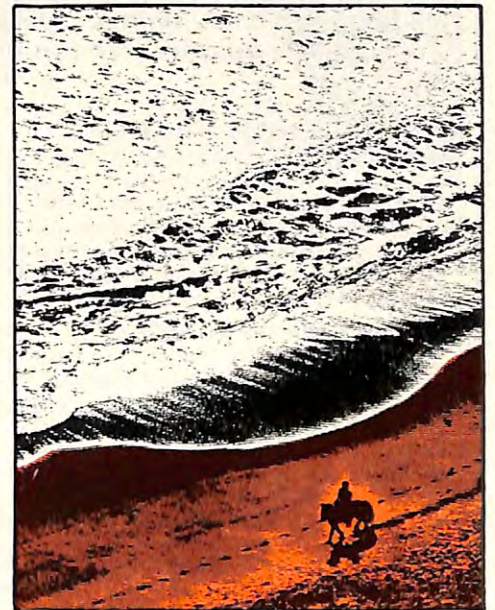

Dick Simmonds and he's the ex-proprietor of Frere Jacques in the San Francisco Bay Area. He arrived in Puerto Vallarta six years ago to launch Daiquiri Dick's, which is where you can get the best you-know-what in all of Mexico. D.D.'s also serves fish 'n' chips, lobster bisque, prime ribs and steaks. Remember the address: Olas Atlas 246. Guests dine indoors or else outside on a terrace that overlooks the sea. It's open for lunch and dinner from 11:30 a.m. till midnight. The daiquiris you can get anytime.

To stir memories, we had lunch at the Occana. It's the hotel where I stayed the first time I came to Puerto Vallarta. This was in 1962 and the prices were outrageously inexpensive. A room with meals for two persons cost only \$14. And even though the hotels weren't elegant, nobody seemed to care. In those days tourists arrived by propeller airplane, a DC-6 as I recall. It unloaded passengers at a ramshackle old terminal that was held together by bailing wire and hope. There were no telephones, no TV, no stop lights in P.V. Only a radio phone. And be-

Introducing... The first solar powered LCD timepiece specially designed for a woman's wrist

The Ladies' Solar Alarm Chronometer by Medana

With electronic quartz accuracy and a 24-hour personal reminder system to keep today's busy woman running on schedule

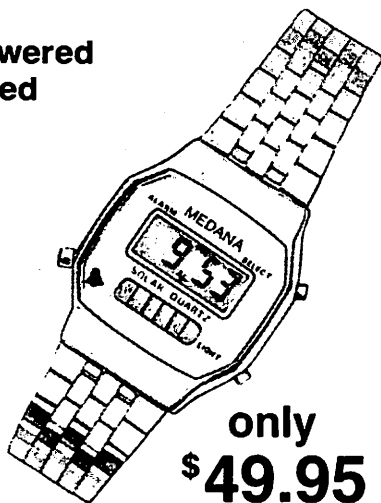

only \$49.95

An alarming design achievement

Until now, the contemporary woman had to settle for a precision LCD timepiece that frankly looked like a clumsy imitation of a man's watch. Medana has changed all that with the elegantly slim, highly accurate Woman's Solar Alarm LCD Chronometer.

Beauty, brains and efficiency

The beauty of the Medana Woman's Solar Alarm Chronometer is immediately apparent. Slender, with a gracefully tapering band, it has the sleek fashion look today's woman requires. Its brains lie in its highly advanced, super-miniaturized micro electronic circuitry, regulated by a finely tuned quartz crystal which provides timekeeping accuracy to within 5 seconds per month! And its efficiency...? What could be more efficient than a watch that's energized by the very light around you! For in addition to being powered by solar light, this distinctive timepiece is actually energized by the photon particles produced by most ordinary light sources. And that's the beauty of it!

Never change a battery again

Imagine! The futuristic Woman's Solar Alarm Chronometer totally eliminates the need for special, hard-to-find batteries. Instead, its solar cells are continually recharged in the course of ordinary wear. In fact, a mere 15 minutes of exposure recharges the cells for over 24 hours. And that means that a year, two years, even ten years from now, your elegant timepiece will still be going strong.

It keeps track for you

The Woman's Solar Alarm Chronometer utilizes the very latest micro technology to offer you a highly reliable and versatile timepiece. To change the easy-to-read LCD display from hour and minute, just touch a tiny button and a seconds read-out will appear. Another light touch will show you the month and date. And, there's a special night light for easy time-telling under reduced light conditions.

A 24-hour personal reminder system, too

To complete the remarkable versatility of this high-performance solar watch is the unique 24-hour personal reminder system. You may set the alarm quickly and easily without disturbing its precise

timekeeping mechanism. A pleasant electronic beep will tell you that it's time to return a phone call, attend a meeting or catch a cab to the airport. It's almost like having a personal assistant with you 24 hours a day.

Now that's a warranty!

As dramatic proof of the manufacturer's confidence in this precision timepiece, there's an unheard-of ten-year warranty on its energy-efficient solar cells. It may well be the watch you'll still be wearing when you decide to retire!

Wear it first for 2,592,000 seconds

We invite you to enjoy the exceptionally fine Solar Alarm LCD Chronometer for 30 full days before you make up your mind. We're sure the test of time will demonstrate how undeniably elegant and indispensable this solar-powered watch really is. If not 100% satisfied that it performs to your own high standards, simply return it after 30 days for a prompt refund.

A surprising value, too

You'll be most surprised to learn that this watch of the future is only \$55.95 in gold-tone and \$49.95 in silver-tone. Please specify color choice when ordering.

CAMBRIDGE INTERNATIONAL, Inc.

8700 Waukegan Road, Morton Grove, Illinois 60053 (312) 966-5510

Call Toll Free 800-621-5559

In Illinois 800-972-5858

24 Hours A Day — 7 Days A Week

Clip & mail to:

Cambridge International, Inc. Dept. E11
8700 Waukegan Rd., Morton Grove, IL 60053

Please send me the Solar Alarm Chronometer(s) indicated below at \$49.95 each for silver-tone and \$55.95 each for gold-tone plus \$2.50 each for shipping and handling. I understand that I may return my purchase within 30 days for a full refund.

Silver-tone Gold-tone
 Check or MO enclosed.
 Charge to: Diners Club Master Charge
 American Express Carte Blanche Visa

Account # _____ Exp Date _____

Name _____

Address _____

City _____ State _____ Zip _____

Signature _____ Cambridge International Inc 1979

CAREYES

cause of the static, it was next to impossible to hear the person you were calling.

"Louder!" you would scream. But it did no good.

This was the charm of Puerto Vallarta in 1962, this idea of shutting out the world. Only fishermen and a handful of vacationers came regularly. It was the Poor Man's Riviera.

Back in '62, the Oceana was everybody's hangout. Sometimes the bar remained open all night. Next morning, the hotel's guests would stagger downstairs cursing the mariachis that had kept them awake till dawn. Pura Bilboa from Spain was the proprietress. There were plans, she said, to pave the road clear to Guadalajara. "But I hope it is never. Too many tourists could ruin this beautiful place."

Well, the road did get paved, but Puerto Vallarta survived. And it hasn't been blighted, as Senorita Bilboa had feared, not like other places have. If anything, it gets better.

While the Oceana still does business, the majority of visitors put up in the newer hotels. The Posada Vallarta for one. The Garza Blanca for another. On this recent trip, I stayed at the Camino Real. It was Puerto Vallarta's first high-rise. For a high-rise it isn't bad. The rooms are clean and comfortable and the service is good. During the day, trinket salesmen wander among bathers just outside the hotel on Las Estadas Beach. Then toward evening, the serape salesmen take over. And after they are gone, a woman with lace shawls appears.

As for dining, there are several good restaurants in town. La Fonda del Sol is a fine one. La Fonda is owned by a German named Bruno, who did a stint at the Mandarin Hotel in Hong Kong. The restaurant has a sunken bar with pillows and a reputation for other romantic nonsense. El Patio still gets good crowds, as does La Margarita with its mariachis.

Puerto Vallarta is accused of being a bit too touristy. They say this about every place that the jet goes these days. Few, though, would have been satisfied with it the way it was before they put up window screens and got hot water. The tourists didn't really want cold shaves and being chewed up by mosquitos, all because the windows had to be left open to keep one from suffocating. What they really were looking for was paradise with plumbing. And that, amigos, is what Puerto Vallarta is today.



Elkdom's clock of 11 played an important part in the staging of the annual Memorial Service. In the background were stained glass-type cathedral windows, accented with flowers and candelabras.

Sharing in the annual Memorial Service were, left to right, PGER Homer Huhn, Jr., chairman; Brother Olen Massey of Grand Prairie, TX, soloist; Rev. John Moeder, Grand Chaplain; ER James Grissom of Houston Lodge, who gave the 11 o'clock toast, and Dan Davis of Van Nuys, CA, past Grand Esquire, who provided the general eulogy.

Grand Lodge Memorial Service

Elks and their ladies paused during the 115th annual session to pay reverent tribute to our departed members.

Silence fell over the huge audience in the Dallas, Texas, Convention Center as acolytes lighted the candles on the altar. A beautiful clock made of flowers with its hands stopped at 11 was featured on the stage. The background included five simulated cathedral-type windows and garlands of flowers.

"... By these services we rekindle the fires of memory and pay a just tribute of affection and honor to our brothers who have journeyed to the distant shores," said PGER Homer Huhn, Jr., chairman, as the program began. "We pay our respects to those who so recently walked with us and who have passed on to a better life."

The audience was thrilled as Brother Olen Massey, soloist of Grand Prairie, TX, Lodge No. 1910, sang "How Great Thou Art," "Whispering Hope," and "Ave Maria." Mary Ann Underwood was the accompanist to Brother Massey.

The 11 o'clock toast was delivered by Exalted Ruler James Grissom of Houston, TX, Lodge No. 151.

"The passing moment is ours long enough to grasp the hand in friendship," Dan Davis of Van Nuys, CA, Lodge No. 2028, Past Grand Esquire and general eulogist, began, "to prove once again that an Elk is never forgotten.

"... Once more the tolling of 11 strokes has revitalized and strengthened our memories. Once more we remember, each in our own way, the warm smile, the reassuring look, and the comforting touch of those held dear.

"Once more we have kept and affirmed our great pact with the heavenly host of Elks who walk through the Heavens, knee-deep in the stars. . ."

The Invocation and Benediction was given by the Rev. Fr. John Moeder, Grand Chaplain. GL Organist Ramon Ringo provided the organ prelude and postlude.

NEWS OF THE LODGES

(Continued from page 36)



CONTRIBUTIONS totaling \$750 were made by the Elks and Elks' ladies of Carmichael, CA, Lodge to Ms. Sally Lanloit (right), who will use the donations to help her obtain a degree in teaching. Ms. Lanloit, who is currently a teacher's aide, is blind and wishes to teach visually handicapped children. Presentation of the checks was made by ER James Stewart.



A STATE AWARD was presented to Est. Lect. Kt. and Chm. Bernie Santisteban of Alhambra, CA, Lodge for his compilation of an album depicting the lodge's participation in youth activities during the past year. Making the presentation was State Chm. C. Vern Forry. Alhambra Brothers congratulated Brother Santisteban on his fine work with local youngsters.



NUMEROUS awards, including scholarships, savings bonds, and trophies, were given to youngsters at a youth recognition banquet sponsored by Tucson, AZ, Lodge. The event was attended by 77 youngsters and their parents. On hand to offer congratulations were (from left) Est. Lead. Kt. Gordon Harland, ER Robert Speer, Hon. Lillian Fisher, justice of the juvenile superior court, Scholarship Chm. Wally Beck, Youth Chm. Darrell Gilman, and then-DDGER Karl Gaither.



NATIONAL FOUNDATION contributors received pins and certificates at Escondido, CA, Lodge recently. The presentations were made by Co-chm. Monty Syrig (left) and Harry Cowper (right). Escondido Brothers congratulated the donors.



DURING RECENT initiation ceremonies at Prescott, AZ, Lodge, PDD W. M. Murie (standing, fourth from left) had the honor of initiating his son Richard (seated, third from left). Richard was the youngest member in a class of six initiates. Offering congratulations to the new members were (standing, from left) PERs Ben Mersereau and Arnold Knuth, PDD Leonard Bellgardt Jr., and PERs William Kelly, Floyd Pigg, and C. S. Braitto.



A SPECIAL visit was paid to Brother Burt Hudson of Tillamook, OR, Lodge on his 100th birthday recently. Brother Hudson welcomed (from left) ER James Williams, GL Committeeman C. J. Wilkins, PDDs Carl Bensheidt and Chester Stewart, and DDGER Thomas Waud. The visitors extended best wishes to the birthday celebrant.



A DINNER-DANCE was held in honor of DDGER Charles Marquand (left) at Torrance, CA, Lodge recently. ER Ralph Gibson (right) was on hand to toast the new dignitary. Brother Marquand is a charter member of Torrance Lodge.

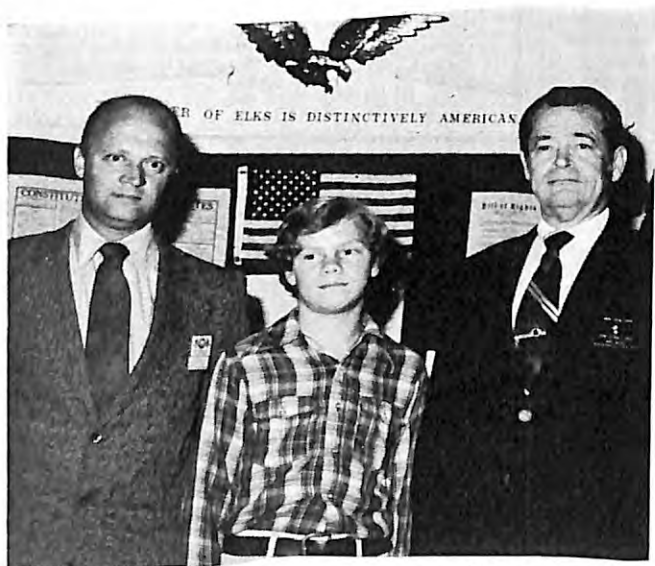

IN RECOGNITION of his many accomplishments, Steve Schroeder (center) received a certificate of commendation from Alameda, CA, Lodge. Brother Stewart Schroeder (left) was on hand to congratulate his young son. Youth Chm. Tom Straughen (right) presented the award, which included a \$25 savings bond, to Steve on behalf of the lodge.



TRAINING guide dogs is a special project for Brother Charles Birnbaum (center) of San Mateo, CA, Lodge. He has trained dogs for 50 years and conducts classes for trainers. San Mateo Brothers sponsor a German shepherd being trained by Theresa Stier (left) and a golden retriever being trained by Dave Bukove (right).



SAN BERNARDINO, California, Brothers donated \$500 to Youth Opportunities Unlimited, a local program which provides jobs and recreation for youths. Mayor W. R. Holcomb (second from right) and Anne Rhodes, director of human services, accepted the check from Treas. Bob Blaikie (left) and Secy. A. W. White (right). The city council may contribute an amount equal to the donations made by the Elks and other local organizations.

DEERSKIN TRADING POST



\$7.99 a pair
Reg. \$11 pr.

His and Hers Pile-Lined Suede Mocs

Here's deep-down comfort, from heel to toe! Handsome, soft-soled mocs are sturdy cowhide suede lined with fleecy acrylic, so they'll feel warm and snug on your feet. Hand-laced vamp with drawstring ties . . . you can adjust the ties for perfect fit. Rich-looking driftwood tan. Whole sizes, medium width; 7 to 13 for men, 5 to 10 for women.

Men's Suede Mocs (Z4904) Price: \$7.99
Women's Suede Mocs (Z4909) Price: \$7.99
Satisfaction Guaranteed or Money Back!
Enclose check, m.o., or credit card information.
Master Charge, Visa.
American Express, Diner's Club.
Add \$2 for shipping & handling.

Mail your order to: **Deerskin Trading Post**, Dept. GN, 119 Foster Street, Peabody, Mass 01960

DON'T BUY A DIAMOND



UNTIL YOU'VE SEEN ZIRCONIA!

Zirconia, the remarkable new man-made jewel, will make you think twice about purchasing a diamond. Handsomely crafted Zirconia shimmers like a diamond, and comes direct to you from the cutters. It costs only \$40 per carat . . . an affordable alternative to diamonds. Select the perfect size to suit the setting of your choice. 10 day money back guarantee if not completely satisfied. Write today for a free handy ring size chart and 104 page, full color catalog.

REGENT LAPIDARY CO.
Dept. EK-109, 2810 Morris Ave., Union, NJ 07083

MAGNIFYING LIGHT

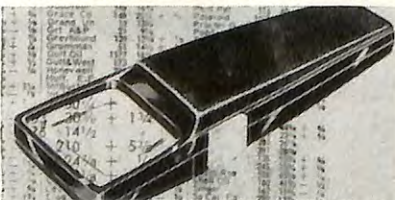

The finest pocket magnifier we've seen in years! Our handy, 5 power model has a built-in, push-button light that illuminates even the smallest detail. Measures a compact 1 1/2"x5", fits easily into pocket or purse. Great for stock and phone listings, map reading, and stamp or coin collecting. Can also be used as an emergency flash. Batteries included. No. 171 **MAGNIFYING LIGHT \$4.98**. Please add 50c for postage and handling.

GAESAR HOUSE Dept. E4, 2945 Radcliff Ave., BX N.Y.C. 10469

Elks Family SHOPPER

Useful and unique new products for indoors and outdoors

DID YOU FORGET?

that there will be no more Bicentennial coinage and no more Eisenhower Dollars minted? This set is a double "keepsake."

BICENTENNIAL MONEY



Set contains a new 1776-1976 Bicentennial Quarter, Half Dollar and Dollar. Also, a new \$2.00 bill minted during the Bicentennial.

COMPLETE SET MOUNTED IN DISPLAY CASE ONLY \$10.00 CASE ONLY (NO COINS) - \$4.50
Add \$1.00 postage. Brochures with order. **IMMEDIATE SHIPMENT.** Allow time for delivery. Satisfaction guaranteed.

VILLAGE COIN SHOP
Dept E Plaistow, NH 03865



DOGGY NEW LEISURE FASHION—4-Legged Pup Jamas keep pet comfortably warm and bedding clean. Designed "full" so as not to hinder freedom of movement. For boys or girls. Available in washable orlon fabric, solid and prints. For size, measure pet from collar to tail, in inches. Sizes 10-12-14, \$8.98; 16-18, \$9.98 + \$1.00 shpg. Accessory Catalog for pup and kitty 25c Du-Says, Dept. 1911, P. O. Box 8850, Metairie, LA 70011

CATALOG

32-PAGE



POOCH DRIZZLER

Keep Fido warm and dry this smart new way! The "Drizzler" is handsomely tailored from transparent vinyl over warm flannel. Hood folds back. Full chest protector keeps pet dry. For proper fit, measure dog from collar to tail. Satisfaction assured!

SIZES: 10-12-14-16-18-20-\$7.98 (Add \$1.00 Shipping)
: 22-24, \$10.98; 26-28-30, \$15.98

FULL-COLOR CATALOG! Newest things for pup, kitty. Pet apparel, accessories. 25¢. Free with order.

DEPT. 917, BOX 8850, METAIRIE, LA. 70011



AT LAST, BIRD FEEDERS THAT FOIL SQUIRRELS! Revolutionary new design features flexible perches that support birds NOT squirrels. Large capacity, multiple feeding stations, built-in water/suet station, free filling funnel, make these the finest feeders available. Wild Bird Feeder for mixed and sunflower seed-shown (460) Finch Feeder for Thistle Seed (465). Order from Springtime, Dept. E101, Wayland, MA 01701. Mastercharge and Visa welcome.



Excellent Christmas Gift

Square Note

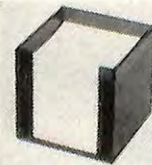

Keep this compact cube close to phones in home or office

Great for taking messages or leaving notes.

Available in clear or smoked plastic.

CUBE SIZE 3 1/2" x 3 1/2"

SATISFACTION GUARANTEED

Filled with your choice of 700 sheets of white or assorted color paper.

\$4.95 each + \$1.50 shipping.

The Cargo Co. Box 33084 Dept. C10 North Royalton, OH 44133

Paper refills \$2.00 each + 50c shipping.

Made-to-Order Kitchen Boss Plaques

THIS IS THE KITCHEN



Personalized With One or More Names
Sure-fire gift for that special person. Choose any title: Den, Bar, Study, Workshop, Room, Home, Beauty Shop. We may have appropriate drawing. 5 1/2"x7 1/2". Solid wood, walnut finish. Shipped to recipient with gift card, if requested. \$5.00 postpaid.

SIMSPRINT Box 79 FAIRFAX, MO. 64446
Longtime Producers of Personalized Plaques

NEED HELP GETTING UP?

TRY A CUSHION-LIFT® CHAIR

Now you can get up at the touch of a button — easily, securely, and without pain or effort. No more waiting for help . . . you can be independent again.

- Medicare coverage in most cases
- Free home demonstration — no obligation
- Free color brochure

A GREAT CHRISTMAS GIFT!



CALL TOLL FREE: 1-800-558-2151



ORTHO-KINETICS, INC.

P.O. Box 2000-EL
Waukesha, WI 53186
Wis. call collect: 1-414-542-6060

HAPPY HANG-UPS

Whimsical, full-color plaques to give to special friends. One features a smiling airplane and proudly declares: "Pilots are just plane people with a special air about them." The other depicts a grinning adding machine and the observation: "Accountants are important sumbodies with well balanced personalities." Both framed plaques are 9½x12" and ready to hang.

- #HU-5005 Pilot \$5.95 postpaid
- #HU-5007 Accountant \$5.95 postpaid

SATISFACTION GUARANTEED!

BILL COLLINGWOOD

Dept. E1079, Box 320, South Miami, Florida 33143

In a RUSH? Add \$1.00 EXTRA per order! "The YOUUnique Catalog" 25¢ or free with order.



Elks Family Shopper consumer/news

Small children seem to think, "Oh, this looks interesting. I think I'll taste it." As a result, about 100,000 children will swallow substances that will poison them this year.

These "poisons" include medicines, household cleaners, perfumes and cosmetics, rat killers, liquid polishes and waxes, fertilizers, paint, and plants.

So what can you do to protect your children? The Food and Drug Administration has a new factsheet that offers suggestions for *Keeping Poisons and Children Apart*. For your free copy, send a postcard with your name and address to the Consumer Information Center, Dept. 661G, Pueblo, Colorado 81009.

Poisonings from plants have increased dramatically in the last few years with the rise in use of house plants for decorating. Some of the poisonous plants found around the house are philodendron, yew, dieffenbachia, poinsettia, African violet, and begonia. If you have small children, keep these plants as far out of reach as possible. And let them know from an early age that plants are not food.

Keep other potentially poisonous substances locked up. If your medicine or cleaning cabinets won't lock, store these products in a place you can lock.

(Continued on page 54)

GIFT GIVING TIME



For Executives

- | | |
|---|--|
| PEN WATCH
\$47.95 SALE PRICE | DESK PEN CLOCK
\$49.95 SALE PRICE |
| <ul style="list-style-type: none"> • Hour • Day • Date • Battery • Refills | <ul style="list-style-type: none"> • 3 function quartz clock • Snooze alarm • Dual time • UM-3 battery |

Pre-Holiday Sale

15 day money back guarantee

Send me ___ Pen watches @ \$47.95 ea
___ Desk pen clocks @ \$49.95 ea.

April 52 ¢ for postage and handling. Florida residents add 4% sales tax.

Name _____
Address _____
City _____ State _____ Zip _____
 VISA MASTER CHG. # _____
Inter Bank # _____ Exp. Date _____
Signature _____

Call or Mail SERCO: (305) 642-4475
2010 N.W. 7 St., Miami, FL 33125

SLEEP WARM—SAVE FUEL



New BED WARMER goes on the mattress. Enjoy soothing, relaxing radiant heat from below. More comfortable and convenient than electric blankets. Yet, COSTS LESS to operate. Drives out cold and dampness.

SAVE FUEL by turning your furnace low at night, and still sleep warm. Automatic thermostat adjusts bed warmth for any changes in room temperature. Six sizes for home use, plus 12 volt models for RV's and sleeper cabs. Also auto seat, chair and pet warmers. Send for FREE booklet. Describes all Electro-Warmth® products, advantages & savings. Great for gifts, too.

PATENTED PRODUCTS CORP.

Dept. E-1079

Danville, OH 43014

DO-IT-YOURSELF FINE GRANDFATHER CLOCK KITS

STARTING UNDER \$220



(including movement and dial)

- Factory direct prices
- Heirloom quality
- Solid ¾" hardwoods: black walnut, cherry, mahogany, oak
- Easy to assemble, parts pre-cut
- Solid brass West German chiming movements
- Money back guarantee
- Prompt shipment

MASTER CHARGE and BANKAMERICARD/VISA ACCEPTED

Write for FREE color catalog

EMPEROR® CLOCK COMPANY

WORLD'S LARGEST MANUFACTURER OF GRANDFATHER CLOCKS

Dept. 208, Emperor Industrial Park
Fairhope, Alabama 36532

"SAVE YOUR HEART"



with a **STAIR-GLIDE®** Stairway Lift

RENTAL-PURCHASE Program Available

America's largest selling stairway lift. Ideal for people who cannot or should not climb stairs. Easily installed in less than 2 hours without damaging stairway. Runs off household current. Choose from Deluxe or Economy models.

AMERICAN STAIR-GLIDE® CORP.

4001 East 138th, Dept. E109
Grandview, Missouri 64030

SPACE-AGE HEET SHEET KEEPS YOU WARM WITHOUT ELECTRICITY

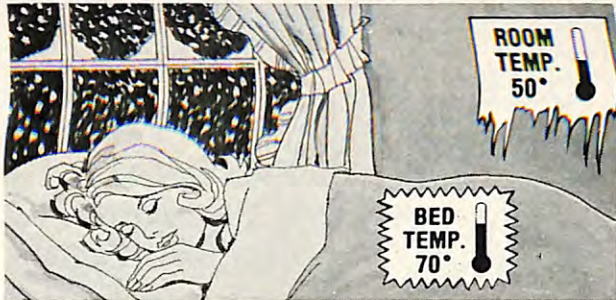

• NO WIRES!
• NO OPERATING COSTS!

only \$8⁹⁸ (Twin-Size)

YOUR OWN REFLECTED BODY HEAT KEEPS YOU COZY!

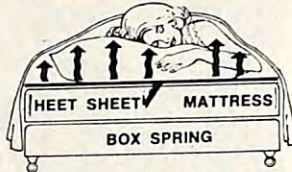

A space-age "miracle!" Made of Thermalfab . . . the super-effective insulating material developed to protect astronauts in the incredible cold of outer space! You sleep on it — not under it. Just place the incredible HEET SHEET between your mattress and bottom sheet. INSTANTLY, it retains and reflects your own body heat right back to you . . . keeps you cozy and warm as an electric blanket without a single watt of electricity! And you stay warm all night with your thermostat turned down; you can save plenty on heating bills. Lets you use lighter-weight blankets too — so you awake relaxed and refreshed. SPACE-AGE HEET SHEET is 100% safe, lightweight and

portable. Never gets dirty . . . the special heat-reflecting fabric is stain resistant too, so it even doubles as a mattress pad.

Order one for every bed in your house (special savings on extras). If not delighted, return within 14 days for refund (except postage & handling). MAIL COUPON TODAY!

© 1979 American Consumer Inc., Caroline Rd., Phila., PA 19176

AMERICAN CONSUMER, Dept. HSH-429
Caroline Road, Philadelphia, PA 19176

Yes! Please send me the SPACE AGE HEET SHEET(S) ordered below:

— (#009) TWIN-SIZE only \$8.98 each (2 for \$16.98)
— (#017) DOUBLE-SIZE only \$9.98 each (2 for \$18.98)
— (#025) KING-SIZE only \$11.98 each (2 for \$22.98)

Please add \$1 postage & handling for one Sheet. \$1.50 for two, \$3 for four.

If after receiving my order I'm not delighted, I may return it within 14 days for refund (except postage & handling).

8558

MAIL NO-RISK COUPON TODAY

Amount enclosed \$ _____ PA residents add 6% sales tax. Check or money order, no CODs please.

CHARGE IT: (check one) Exp. Date _____
 BankAmericard/Visa American Express
 Master Charge Bank Number _____

Credit Card # _____

Name _____

Address _____ Apt. # _____

City _____ State _____ Zip _____

Canadian Customers please send orders to: Mail Store Ltd.
Dept. HSH, 312 Rexdale Blvd. Toronto, Ontario M9W1R6
(Ontario & Quebec residents add sales tax)

Elks Family Shopper consumer/news

Keep hazardous substances in their original containers. There have been instances where poisonous substances put in cups or soda bottles were swallowed by a small child who did not realize what was in them.

Make sure both prescription and over-the-counter medicines have safety caps. They work. Deaths from aspirin, very common ten years ago, have dropped substantially since the introduction of child-proof caps.

Get rid of any unused medicines or household products by pouring them down the drain or toilet. Rinse the container before you discard it.

Never tell a child medicine is candy or tastes like candy.

Don't take medications in front of a child. Your son or daughter might try to imitate you by taking the medicine when you aren't there.

Keep a one-ounce bottle of syrup
(Continued on page 56)



IT'S IMPOSSIBLE TO STEAL THIS PORTABLE SAFE! Drop it in top desk or bureau drawer, and your jewels, money, medication can't be stolen unless the thief takes the furniture! Porta-Vault works with two lids. One locks closed, sealing your valuables, and one locks open to wedge against furniture lip, preventing removal of safe or drawer. Releases only with the set-it-yourself combination lock. Heavy duty steel box is 9x6x2"

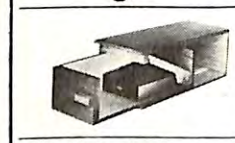

protectively lined. Use it in hotel room, office and home as an instant tamper-proof safe. 1yr. Warranty. Satisfaction Guaranteed. \$47.95 + \$3.50 shpg. (direct from U.S.). Inexco Enterprises, Dept. K2, 92 Ewen Rd., Hamilton, Ontario, Canada L8S-3C5.

RAMS-AIR Fireplace Furnace

HEAT YOUR HOME-SAVE MONEY

The amazing fireplace furnace that heats 2,000 sq. ft. at 1/2 the cost.

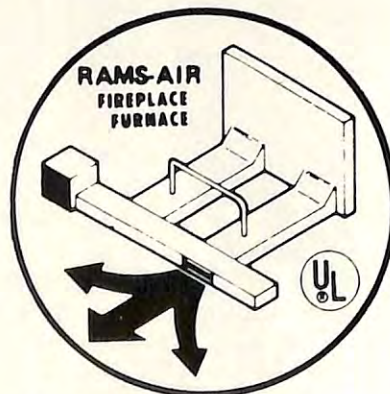

Easily Installed!
Fits Most Fireplaces!
15466 SW Summerfield Lane
Tigard, OR 97223
Phone: (503) 620-6031
Write or call for free brochure and measuring chart.

The Quartering Wedge
A New Concept in Wood Splitting
"You won't believe how easy it is to split wood!"



FOUR pieces instead of TWO with less TIME & EFFORT

Sturdy Construction One Piece Drop Forged 7 1/2 lbs. Patent Pending. Money Back Guarantee Against Defects in Workmanship. Makes a Perfect Gift.

SAVE ENERGY

only \$19.95

Add \$4.00 Postage & Handling. MA residents Add 5% Sales Tax

Send Check or Money Order to
LAVIGNE & GAUTHIER, Inc.
P. O. Box E 106 Ludlow, MA 01056

World-Wide Exclusive

**FROM THE
American Treasury...**

Norman Rockwell

FIRST-ISSUE COLLECTORS' MUGS



Genuine Porcelain
Featuring 4 World-Famous Full-Color Illustrations
Trimmed in 22-Karat Gold



Little Spooners



No Swimming

Big Moment

The Doctor and The Doll

illustrations
from
**THE
SATURDAY
EVENING
POST**

**EACH \$5
ONLY**

Special Offer! Entire Set of 4 ONLY \$15⁹⁷

Now! For the first time anywhere, you can own these beautiful porcelain collectors' mugs honoring the immortal Norman Rockwell. They won't be sold in any store, they cannot be obtained anywhere else except through this offer (unless, of course, you purchase them later from a collector!).

For over half a century, as our nation's beloved "artist in residence," Norman Rockwell made history come alive, everyday family events we take for granted became celebrations of life, capturing the very spirit of America!

Yes, as a tribute to this gifted artist, The American Treasury proudly presents a collectors' first...the initial collection of genuine porcelain mugs featuring 4 world-renowned Norman Rockwell scenes. Each heartwarming work has been faithfully reproduced in its original full-color detail, bearing the artist's unique signature—just as it appeared on a memorable Saturday Evening Post magazine cover years ago. The graceful, pure white mug stands 4 inches tall, and is trimmed on the rim and handle with gleaming, real 22-karat gold! Display these handsome creations in your favorite case or hutch, on a special table or shelf, or delight guests by serving their coffee or tea in one of these distinctive Rockwell Mugs!

Authorized & Licensed by The Saturday Evening Post for Exclusive Issue by The American Treasury!

Don't miss this exceptional opportunity. Another set of Norman Rockwell Porcelain Mugs will be issued soon, bearing 4 different scenes. This original series offer might not be repeated. And remember, these fabulous Mugs are an American Treasury world-wide exclusive—they cannot be obtained anywhere else, for any price. By ordering now, you will own and enjoy the first in this exciting new Norman Rockwell Collectors' Series, plus you'll be eligible to acquire later Mugs as they are issued. Naturally, your order is for this First Issue only; you will not receive others unless you specifically order them. You must be delighted with the charm and craftsmanship of your Mug order, or you may return it within 14 days for a refund of your purchase price (less postage and handling, of course). Mail coupon today.

© 1979 Panacolor, Inc., Caroline Rd., Phila., PA 19176

MAIL NO-RISK COUPON TODAY

AMERICAN TREASURY, Dept. NRB-18
Caroline Road, Philadelphia, PA 19176

Please send me the Norman Rockwell First-Issue, Genuine Porcelain Mug(s) ordered below for \$5 plus 75¢ postage & handling each.

___ (# 005) Little Spooners ___ (# 021) No Swimming
___ (# 013) Dr. and the Doll ___ (# 039) Big Moment
___ (# 047) Entire Set(s) of 4 Mugs only \$15.97 plus \$2 postage & handling—SAVE \$5.03

SAVE! 2 Complete Sets (8 Mugs in all) only \$28 plus \$3 postage & handling—SAVE \$15.00

If after receiving my order, I'm not completely satisfied, I may return it within 14 days and you will refund my purchase price (less postage & handling, of course).

Total amount enclosed \$_____ PA residents add 6% sales tax. Check or money order, no C.O.D.s please.

CHARGE IT! Exp. Date: _____
 Visa American Express
 Master Charge, bank # _____

Credit Card # _____
 Sign _____
 Name _____
 Address _____ Apt. # _____
 City _____ State _____ Zip _____

Canadian customers please add 50¢ per Mug and send orders to: Mail Store, Ltd., Dept. NRB-18, 170 Brockport Drive, Rexdale, 8353 Ont. M9W 5C8. (Ont. & Que. residents add sales tax.)

—Div. of Panacolor, Inc.

Your Dollar Still Has Clout At RVP



\$1.00 BRINGS YOU 100 Vitamin E 400 I.U.

Mail **\$1.00** Today To:

(LIMIT ONE BOTTLE PER HOUSEHOLD WITH THIS AD)



Vitamin Products

16 NASSAU AVENUE ROCKVILLE CENTRE, N.Y. 11570

8ELK-22

NAME _____

ADDRESS _____ APT. _____

CITY _____ STATE _____ ZIP _____

"Most claims for woodstoves are a lot of hot air."

If you're tired of hearing about "thermostatically controlled downdrafts" and paying more for stoves with Danish proverbs on the front, maybe you'd find this booklet both interesting and profitable. It's yours for the asking and \$1.00 for postage and handling.

MAKING SENSE OUT OF WOOD STOVES

Write to Hayes Equipment Corp. P.O. Box 526-E, 150 New Britain Ave., Unionville, CT 06085, 203-673-2556. Dealer inquiries invited.



Our Model 501 Fireplace Stove has a full baffle and internal damper (most stoves don't have either), plus a safety glass door section for viewing the fire.

Better'n Ben's®
Our stoves make more sense.

Super Gift For Super People



Remarkably attractive and sure to leave a lasting impression. Twisty Flex-O-Loc Key Keeper with the Elks Medallion—or your favorite sport. Available in 18 kt gold or silver finish. Made of flexible stainless steel aircraft cable with the patented Flex-O-Loc closure. Life time guarantee. Gift box.

Price \$4.98 plus 50¢ postage and handling.

Send check or M.O.

DIXIE PRODUCTS

P.O. Box 1370, Hurricane, Utah 84737

U.S. COINS BY THE POUND & GOLD



Rather than sort overflowing vaults, these are sold by the pound! GOLD PIECE of the world added! All coins 30-150 years old. May include Indian, Lincoln cents; silver dollars; 2¢; 3¢ pcs. etc. 1 lb.—\$16.50; 2 lbs.—\$30; 5 lbs.—\$72; 10 lbs. (plus 2 gold pcs)—\$130.



LAST U. S. SILVER COIN SETS

Never again will silver be used in coin mintage! Most has already been remelted so these UNCIRCULATED coin sets increase in value! 1964-\$9.50; 1963-\$10; 1962-\$10.50; 1961-\$11; 1960-\$11.50. All sets \$49.50 (mounted in lifetime holders). Special 1955 thru 1959-\$98. All major credit cards accepted. (Add exp. date.) Add \$2 for ins. & hndlg. Centre Coin Co., Box 1, Dept. K10, Sherman Oaks, Calif. 91413.



America's BEST Values!

greenhouses

Shatterproof fiberglass/California Redwood. Designed for the home gardener. Freestanding, lean-to and dome models, accessories. Use my "guaranteed price" lay-away plan. Write today for my FREE fact-filled, helpful color catalog.

Peter Reimuller —The Greenhouseman®
980 17th Ave., Dept. 12-K, Santa Cruz, Ca 95062

Elks Family Shopper
consumer/news

of ipecac handy, but *don't* use it unless you are *directed* to do so by your doctor or the poison control center.

Keep the number of your local poison control center near the telephone in case of emergencies.

Flowers add a personal touch to your home. An economical way to change the flowers to suit your mood year 'round is by making your own **dried flower arrangements**.

Before you start plucking flowers from your garden, send for the U.S. Department of Agriculture booklet that tells you step-by-step how to keep your flowers in good condition for years. For a free copy of *Dried Flower Arrangements*, just send a postcard to the Consumer Information Center, Dept. 679G, Pueblo, Colorado 81009.

You can use flowers from your garden. You can also discover some interesting wildflowers for drying along country roads or in the woods. But just be sure to avoid the bright red, 3-lobed poison ivy. Here are some simple methods

(Continued on page 58)

CHOOSE YOUR FREE BADGE (OVER 1,000 CHOICES)

Save Big—supply your group or raise funds taking orders from others. Simple make-it-yourself hand die press comes complete with illustrated instructions. You can pop out badges, key chains, pendants, purse-mirrors, even yo-yos, each customized the way you want them. GET FREE sample button and color catalog or send \$24.95 plus \$1.75 shipping (Illinois Residents add 5% sales tax) for complete kit. (Unconditional Money Back Guarantee!)



NOW! YOU CAN CUSTOM-MAKE BUTTONS FOR ANY OCCASION.

BADGE-A-MINUT, Box 618, Dept. EL-109 LaSalle, IL 61301

EXCITING STAMP COLLECTION FROM 19 EXOTIC ISLANDS—ONLY 10¢

55 Different stamps from islands where adventure, romance abound. Antigua, Sri Lanka, more. Attractive price lists included. ADULTS ONLY. Just send 10¢ to: MYSTIC STAMP CO., Dept. A-31, Camden, New York 13316



JAPANESE DOLLAR—ONLY 10¢

Issued by Japan in 1942 for the invasion of Malaya. Add this scarce banknote to your collection. Limit one. ADULTS ONLY. Plus wonderful price lists. Send 10¢ to: LITTLETON COIN CO., Dept. JD-67, Littleton, New Hampshire 03561



NOW! GET MINT MIDGET 13¢ U.S. INDIAN HEAD PENNY STAMP ONLY 10¢



Only 10¢ brings you this seldom seen stamp. Plus unusual mint 8 4¢ U.S. stamp. Wonderful price lists included. Limit 1. ADULTS ONLY. LITTLETON STAMP CO., Dept. PS-18, Littleton, New Hampshire 03561.

WOODWORKERS

Do-it-Yourself CATALOG

SAVE VAST SUMS. Build, restore, re-finish anything of wood! Here's everything you need. Fine woods, veneers, specialty tools. Cabinet hardware, period & modern. Pro finishes. Cane. Lamp parts. Uphol. supplies. Picture moldings. Clock kits. 100's of plans. Instruction books. Thousands of hard-to-find woodworker products in big new catalog. Mail ad for Catalog & 20 beautiful Wood Samples.



CONSTANTINE Est. 1812
2058 Eastchester Road, Bronx, N.Y. 10461

Send \$1 for 104-page Woodworkers Catalog with 20 beautiful Wood Samples, all identified. Dollar refunded on first order.

Name _____
Address _____
ZIP _____

HANGING WINDOW GARDEN

Provides perfect climate for favorite plants. **\$14.00**
MASTERCHARGE AND VISA WELCOME

Two clear 21" trays (one for 4" and one for 6" pots) hold gravel and water for ideal humidity. Heavy gauge white steel brackets attach easily to sash — *window still opens!* Holds heaviest plants solidly and securely.

Hanging Window Garden \$14.00 (Postage Free)
Separate trays only \$4.50 Ea.
Please specify for 4" or 6" pots.

Springtime Dept. E010
31 ALDEN RD., WAYLAND, MA 01778 • (617) 358-5106 Ex 100

FREE WOODCRAFT CATALOG

A complete line of ready-to-assemble quality furniture and accessories in a variety of woods—oak, cherry, walnut, birch and pine. Includes grand-father clocks, music boxes, roll-top desks, gun and tool cabinets, decorative wall hangings, planters, even Tiffany lamps. 145 items in all. Build any of them at a fraction of store-bought prices! Easy to assemble. No special skills or tools needed. Mail coupon to get your free color catalog. No obligation.



Woodcraft Collection Dept. 4FW
1400 North Fruitridge Ave., Box 1174
Terre Haute, IN 47811

Please send me my FREE color Woodcraft Collection catalog.

Print Name _____
Address _____ Apt. _____
City _____
State _____ Zip _____

Amazing Automobile Tire Cleats Guarantee!

You'll Never Get Stuck In Snow Or Ice Again!

- Gives positive traction.
- Steel cleats won't break or slip.
- No jacking-up wheels.
- Goes on easily . . . releases quickly.
- Ideal for cars and light trucks.



Remember the last time you sat in your car helplessly spinning your wheels . . . trying to get out of a deep snow and ice bank. The more you gunned your engine, spun your wheels . . . the deeper you sank—STUCK! The only way to get going again was to dig out—or get a tow!

RELAX . . . TAKE IT EASY!

With our fantastic positive traction TIRE CLEATS ready for instant use, you'll never get stuck in snow or ice again. GUARANTEED! You won't have to dig out . . . you'll drive out in seconds with super tractor traction. Made like true tank/tractor treads of hardened steel, TIRE CLEATS bite deep into ice and snow at every turn of the wheel, thrusting . . . urging the car forward with no slipping, no skidding. TIRE CLEATS install quickly without jacking up the wheels. Fits cars and vans . . . even light trucks. Set of 2 TIRE CLEATS only \$6.99, well worth the price that saves you back-breaking shoveling and exhaustion and expensive towing charges. If you're not satisfied with your TIRE CLEATS, if they don't live up to the guarantee you'll never get stuck in snow or ice again, return them in 90 days for a complete refund of your purchase price (less postage and handling, of course). Order NOW!

© 1979, Encore House, Inc., Roberts Lane, Glen Head, NY 11545

MAIL THIS NO-RISK COUPON TODAY

ENCORE HOUSE, Dept. TC-79
Roberts Lane, Glen Head, NY 11545

Yes! Please RUSH me the positive traction TIRE CLEATS I have ordered below. I understand that if I'm not fully satisfied with my order, I may return it within 90 days for a complete refund of my purchase price (less postage and handling, of course).

(#001) 1 Set of two TIRE CLEATS only \$6.99 plus \$1.25 postage and handling.

(#002) SAVE \$2.74! 2 Sets of TIRE CLEATS (four cleats) only \$11.99 plus \$1.75 postage and handling.

(#004) SAVE \$9.97! 4 Sets of TIRE CLEATS (8 cleats) only \$19.99 plus \$3 postage and handling.

Amount enclosed \$____ (NY residents please add sales tax.)
No C.O.D.s please.

CHARGE IT! VISA (BankAmericard) Master Charge

Credit Card # _____ Exp. Date: _____
Name _____
Address _____
City _____ State _____ Zip # _____

THE UNIQUE Instant Speller

- **FASTER AND HANDIER THAN ANY DICTIONARY**
- **6,000 MOST COMMONLY MISPELLED WORDS ARE CORRECTLY SPELLED, DIVIDED AND ACCENTED.**

An aid to business and professionals, students, secretaries. Puts a world of words right at your fingertips. Works on touch method. Press down release tab with pointer on first letter of word wanted. In a flash find your answer. No pages to turn. For every home, every office, this side of genius. A perfect gift.

Credit Cards Accepted: BankAmericard (Visa) or Master Charge. Give Card No. and Exp. Date. Only **\$5.99** each. 2 for \$11 plus \$1 postage & handling. Calif. add 6% tax.

Instant Speller Co., Dept. E1079 • 125 So. Western Ave., Los Angeles, Calif. 90004



30-DAY MONEY BACK GUARANTEE.

At Last!
A Full-Feature Workbench at an Affordable Price!



- Huge 12½ sq. ft. surface area
 - Solid rock maple construction (225 lbs!)
 - 2 large-capacity vises
 - Rugged 2" thick laminated top
 - Massive 9" x 18" vise jaw will hold even delicate work
 - Adjustable leg levelers adjust workbench to uneven floor surfaces
 - Easily disassembles for moving
 - Available in kit form, too!
 - Optional tool well & tool drawer also available
- Until now, quality workbenches have usually been too expensive and too small. This huge, extremely versatile bench is available direct from the factory at an incredibly low price.

Made in U.S.A.

Garden Way Research, Dept. 90120W
 Charlotte, Vermont 05445

TO: Garden Way Research, Dept. 90120W
 Charlotte, VT 05445

Please send me your free information about the New Garden Way Home Workbench, including details on the build-it-yourself kits.

Name _____
 Address _____
 City _____
 State _____ Zip _____

Why do so many Men swear by Wright Arch Preservers®



SEND FOR FREE CATALOG

Because ARCH PRESERVER construction assures complete foot comfort and protection.
 Because WRIGHT ARCH PRESERVERS have an unequalled reputation for quality and excellence for over 100 years.
 Because they come in a wide range of styles, sizes, and widths . . . AAA to EEE - 6 1/2 to 16.

MAIL THIS COUPON TODAY!

Executive Shoes, Brockton, MA 02403
 Dept. 369 Box 488

Send me FREE catalog of Wright Arch Preserver Shoes

Name _____
 Address _____
 City _____
 State _____ Zip _____

Have you worn Wright shoes before?
 Yes No

AMAZING SPACE-AGE BLANKET
 COULD SAVE YOUR LIFE!



Unfolds to 56" x 84"

Metal-backed mylar blanket weighs only 2 ounces, reflects 90% of body's natural warmth. A must for every car. Don't freeze to death in stranded car on winter roads. Wrap up in blanket to stay warm with engine off. Avoid carbon monoxide suffocation, most frequent cause of death when marooned. Leave in glove compartment and feel secure.

Pocket-size protection for warmth in any emergency. Perfect for travelers, hikers, hunters, cyclers, yachtsmen, skiers. Money-back guarantee. \$3.00 each. Two for \$5.50. Add .50 for shipping.

Survival Systems Ltd.

Dept. E, 41 Topsfield Rd., Ipswich, Mass. 01938

PLAY ANY TUNE With A **TRU-TONE HARP**
 \$5.95 Postpaid

NEW PATENTED DESIGN

- * FINEST JEW'S HARP MADE
- * CLEAR MUSICAL SOUND
- * ILLUSTRATED INSTRUCTIONS

TRU-TONE HARP CORP. Box E
 4805 S. E. 26th • Portland, OR • 97202

Mrs. Frederick D. Johnson
 221 S. 23rd Street
 West Highland Park
 Anytown, Kansas 80940

1000 RETURN ADDRESS LABELS \$1.00

1000 gummed economy name and address labels printed in black with ANY name, address, zip code. Up to 4 lines.
 Order \$717 Set of 1000 Economy Labels (boxed) . . \$1.00

250 Self-Stick GOLD FOIL LABELS \$1.98

GLEAMING GOLD FOIL

Glaming gold foil labels stick to any clean, dry surface - need no moistening. Rich black printing, classic border.
 Order P6128 Set of 250 Gold Foil Labels (boxed) . \$1.98

250 Self-Stick WHITE GLOSS LABELS \$1.98

STICKS AT A TOUCH

Glossy white self-stick labels cling to any smooth surface - no moistening. Sharp black printing up to 4 lines.
 Order P6030 Set of 250 White Gloss Labels (boxed) \$1.98

Walter Drake 3290 Drake Bldg.
 Colorado Springs, CO 80940

NAME _____
 ADDRESS _____
 CITY & STATE _____ ZIP _____

____\$717 1000 Labels @ \$1 each \$ _____
 ____P8128 Gold Foil Labels @ \$1.98 each \$ _____
 ____P6030 White Gloss Labels @ \$1.98 ea \$ _____

Add 20¢ per set for postage & handling \$ _____
 SATISFACTION GUARANTEED Total \$ _____

Elks Family Shopper

consumer/news

for preserving the blooms:
 © *The air drying method.* Just strip foliage from fresh cut flowers. Sturdy flowers such as zinnias, marigolds, strawflowers, herbs, and mints work well. Tie loosely in small bundles, and hang upside down in a warm, darkened room for 1 or 2 weeks. Store in cardboard boxes until you're ready to use them.
 © *The glycerine method.* Smash the stem bottoms 2 to 3 inches of fresh cut magnolia and other broad-leaved evergreens. Place stems immediately in 4 or 5 inches of solution consisting of 2 parts hot water to 1 to 2 parts glycerine or anti-freeze. Add more solution as it is absorbed. Soak 2 to 3 weeks or until leaves have become supple and golden brown.



Carol's illness prevented her from climbing these stairs like she used to. She could move to a one-story house, but she loves this house. A *Cheney Wecolator™* solved Carol's problem by letting her ride from floor to floor quickly and comfortably. As the first stairway elevator to be UL-listed, it's virtually maintenance-free and can be installed in just a matter of hours. For a colorful brochure on *Cheney Wecolators*, or *Wheelchair Lifts* and *Wheelchair Van Lifts*, contact your local Cheney Representative or write: The Cheney Company, Dept. EM, 3015 S. 163rd Street, New Berlin, WI 53151. (414) 782-1100.

Helping people help themselves.
CHENEY Wecolators.

CUSTOM PIPE TOBACCO

The world's finest tobaccos custom blended for the ultimate smoking pleasure. Write for free catalog. **SAMPLER PAK** of 5 unique blends. \$1.25 ppd.
GREEN RIVER TOBACCO CO. Dept. 30
 P.O. Box 1313, Owensboro, Ky. 42301

Fantastic Price Break! Only \$5.98

NOW AVAILABLE
TO THE PUBLIC



KEEP THAT "SHOWROOM SHINE" FOR 3-YEARS AND NEVER WAX, POLISH or BUFF AGAIN!



POLYMER GLASS MIRACLE SEALANT APPLIES IN LESS THAN 1 HOUR!

PROTECT NEW OR USED CAR PAINT AND BRIGHTWORK AGAINST ALL THESE HAZARDS!

- | | | | |
|----------|------------------|----------------|------|
| SNOW | SMOG & POLLUTION | BUGS | MUD |
| RAIN | OCEAN SPRAY | TREE SAP | ROAD |
| SUN-WIND | AIRBORNE SOOT | BIRD DROPPINGS | SALT |
- EVEN VANDALISM FROM MARKING PENS!

Not a wax! Not a polish! A miracle of modern chemistry!

You simply wipe it on to "wrap" your car in a protective glass-smooth surface! Just as acrylic finishes revolutionized the paint industry... just as epoxy adhesives made ordinary glues obsolete overnight... now a breakthrough in chemical science has produced an incredibly hard, super glossy, non-stick "polymer glass" sealant that can "glass in your car's showroom shine" virtually for its lifetime!

The Famous "Shock Test" Dealers Use

Dealers who have been charging an arm and a leg for this fabulous treatment have a standard sales pitch. They wipe a bit of this amazing formula on your car and then, while you're watching, deface it with a marking pen. Almost before you can scream in protest, they simply wipe it clean again! And while you're still speechless, they sell you a complete "glassing" for anywhere from \$85 to \$200 — whatever they think they can get!

The Secret is Simple — The Magic is in the Product

Glasscote's polymer glass formula

literally fuses itself to the finish of your car by "molecular bonding". And it contains a formulation similar to that used to make those "non-stick" frying pans, so it's so glossy smooth that practically nothing will stick to it! Even bird droppings and crushed insects simply slide off with the touch of a damp cloth.

It takes less than 60 minutes to Glasscote your car

Now you can get the identical protection for your car with Glasscote, and all you need do is all the dealer does — wipe it on, let it dry, and wipe it off! So why pay somebody \$85-\$200 an hour to do it for you? Why not buy Glasscote direct-by-mail for only \$5.98 — enough for three years treatment for a small car — more than enough to Glasscote even the biggest Mercedes, Rolls, or Cadillac for 12 full months! Simply wipe it on once a year and forget about all that waxing, polishing, and buffing forever! A simple soap and water washing or a wipe with a damp cloth restores the gloss!

Even if your used car is already dingy looking from oxidation, Glasscote helps remove it and restore a brighter color and more glossy shine.

Once you seal your car in Glasscote, its finish and chrome is immune to the worst conditions nature or man can devise! You're protected against:

- ... oxidation that can fade or change paint color
- ... corrosive smog, acid precipitation, industrial pollution, oily airborne soot
- ... road tar stains and smudges
- ... sticky tree sap, crushed insects, bird droppings
- ... salt sea air or road salt splashes that can pit, corrode and destroy chrome.

Save Gasoline — Add Resale Value to your Car

Experts say the smoother your car's finish, the less wind resistance it has, which means it can go farther on a gallon of fuel. And when you come to sell your car, you know what a difference appearance makes. A car with "showroom gloss" three, four, or five years old is bound to bring hundreds of dollars more than the same car with dingy, oxidized finish. So release yourself forever from the bondage of constant waxing and polishing, and insure yourself of top dollar on your trade in years from now! Mail coupon now!

3 YEAR GUARANTEE!

Simply use Glasscote as directed. If its "showroom shine" is not maintained for a period of 36 months, if the Glasscote surface doesn't totally and completely please you, its glossy, dirt-repellent qualities are not instantly apparent and noticeably superior, if you're not delighted in every way, return the unused portion to National Home Products, Customer Service, 60 Wilton Road, Westport, CT 06880. Our refund check for the full purchase price (except postage & handling) will promptly be sent to you!

MAIL NO-RISK COUPON TODAY

NATIONAL HOME PRODUCTS, Dept. GCS-41
60 Wilton Road, Westport, CT 06880

Please send me _____ bottle(s) of Glasscote at \$5.98 plus \$1 shipping and handling per bottle.

If at any time in the next 3 years my car loses its "showroom shine", I may return the unused portion for full refund (except shipping and handling).
SAVE: Order 2 bottles for only \$10.98 postpaid.

Total amount enclosed \$ _____ CT residents add 7% Sales Tax.

Check or money order, no C.O.D.'s please.

Charge it please to: American Express Visa

Master Charge (Bank Number _____)

Card No. _____ Expiration Date _____

Name _____

Address _____ Apt. # _____

City _____ State _____ Zip _____

Sun Shield

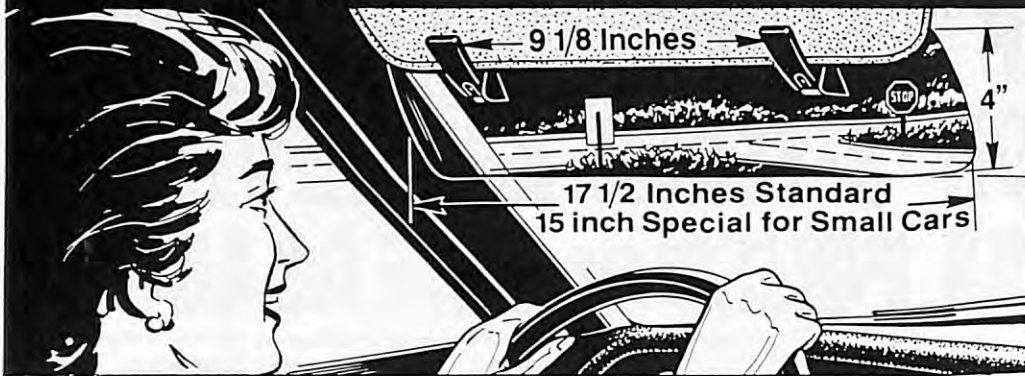

DOUBLES your driving COMFORT

- Reduces ALL GLARE and HEAT, front or side, Day or Night
- Accepted by leading safety authorities • Positive screw clamps hold securely
- Universally adjustable for look-through or shade-and-look-under.
- SATISFACTION GUARANTEED (Return within five days for full refund)

THE IDEAL GIFT • MOST ENJOYED • MOST APPRECIATED

Sun Shields, Inc. • Box 351 • Plymouth, MI 48170

Check or money order enclosed; Michigan residents ONLY add 4% tax.

- \$5.00 for one Sun Shield, shipped postpaid promptly.
- \$9.00 for 2 Sun Shields - Make your passenger comfortable, too!
- \$42.00 Doz. (minimum, one order) for group buyers - fleet owners.

E Specify 15 in. LENGTH (not car model) for sub compact & small foreign cars.

Name _____ Street _____

City _____ State _____ Zip _____



Make Spline Maple

This is not a lowly pun, but in woodworkers' parlance refers to the use of a third piece, or spline, to join two pieces of wood together. There are even blind and multiple spline joints.

Fine Woodworking magazine speaks this language to more than 100,000 readers—people seriously interested in making beautiful things out of wood. Whether you are an aspiring novice or an accomplished expert, you'll find it an especially informative magazine, with finely detailed articles about techniques and tools, materials and design. It's written by master craftsmen who share their many years of wood-working experience. And it's printed on heavy paper to withstand years of reference. All back issues are in print and indexed periodically.

If you want to become a better woodworker, write for more information about this beautifully illustrated bimonthly magazine. Better yet, send \$12.00 for a one-year subscription (Visa or Master Charge accepted). If you're not pleased, we'll be happy to refund.

Fine Woodworking
 The Taunton Press
 52 Church Hill Rd.
 PO Box 355-LD
 Newtown
 Connecticut 06470

WORLD'S FINEST 12 VOLT CHAIN SAW

BATTERY POWERED CHAIN SAW
 The Perfect Christmas Gift

IDEAL FOR

- Woodcutters • 4 Wheelers
- Sportsmen • Farmers
- Carpenters • Landscapers

BUILT TOUGH, LIGHT WEIGHT

SPECIAL INTRODUCTORY OFFER
\$99.95
 Postage Paid To Your Door

FOR FREE BROCHURE OR TO ORDER
 CALL 1-503-638-8602

THE EARTH SAW
 P.O. BOX 8
 11975 S.W. HERMAN ROAD
 TUALATIN, OREGON 97062

NON-METAL TAPS SAVE HEELS

Quiet, No-Skid, Like new with NO-NOISE

Run-down in 3 months Steel-Tough

Amazing polyurethane taps keep heels perfect for months. Attach in seconds to any heel, and no one can tell you're wearing taps. Men or ladies size.

KICK SHOE REPAIR COSTS TODAY!
 Money-back guarantee.

7 pair only \$2. 12 pr. \$3.

(Can save you \$4.00 in heels) ©1971
HALE HEEL COMPANY
 44 Chip Rd., Middlefield, Mass. 01243

B.P.O.E.

12" x 24" MIRROR WITH ELKS LOGO

DISTINCTIVELY ATTRACTIVE

Appropriate Gift for Home, Office, Recreation Room

Address 16.50 to:
 Concept Sales, Inc.
 P.O. Box 454
 Bristol, IND. 46507

Will ship prepaid 14 days

NOW! ANYONE CAN HAVE A BABY...

TEST TUBE BABY

Yes anyone can have a TEST TUBE BABY from Las Vegas, Nevada. This lovable little character will delight people of all ages. The perfect conversation piece for any and all occasions. This baby comes complete with its own red, white & blue convertible carrying case & cradle. Also included is a fully illustrated comical booklet all about America's 1st TEST TUBE BABY.

Please send me _____ TEST TUBE BABY(s) at \$4.95 each, plus \$1.00 shipping.
 Enclosed check or M.O. for \$ _____

Name _____
 Address _____
 City _____ State _____ Zip _____

(Nevada residents add 3 1/2% sales tax)
 MARK EMBRY ENTERPRISES 130 S. 4TH ST. STE. 29
 LAS VEGAS, NEVADA 89101

WOODLAND **PLAQUES**

We interrupt this marriage to bring you the fishing season

Season your marriage with humor.

Genuine wood plaques, beautifully carved with your choice of hobbies. Flame burnished, sealed with a velvet finish and accented with delicate flowers, hand-painted by the handicapped. A full 1½" thick, block of western pine, 10" x 11", thick enough to stand on your desk, furniture, shelves, etc., or can be wall mounted. A great conversation piece in your home, office, boat or R.V. A truly unique gift. Select your hand crafted wooden plaque and order today. Only \$11.95 or save \$2.00 C.O.D. charges. Send check or money order for \$9.95 each.

WOODSEY WIT & WISDOM
1376 "C" E. Grand Avenue, Pomona, California 91766

NAME _____ CHECK YOUR CHOICE
 Football
 Fishing
 Hunting
 Baseball
 Bowling
 Golfing
 Soccer
 Other _____

CITY _____ STATE _____
 ZIP _____ PHONE _____
 Satisfaction Guaranteed.

LIMITED EDITION **THE GOLDEN "SUSAN"**
 First-day-of-issue Susan B. Anthony United States Dollar.

Electroplated with **GENUINE 24-KARAT GOLD!**



YOU'LL RECEIVE: This handsome album cover bearing a portrait and biography of Susan B. Anthony which protects each folio!

Coin in die-cut mounting for viewing both sides with Portrait and Life Highlights in Steel Engraving technique

To commemorate the first time an American Woman has ever been honored on a U.S. coin, The Westport Mint has obtained a limited supply of the first Susan B. Anthony dollars released on July 2, 1979.

CERTIFIED FIRST DAY OF ISSUE!

Each uncirculated, mint-condition coin honoring the pioneer of Women's Rights, is plated with the enduring bright beauty of real gold — an added value your eyes can easily verify! Each is presented in a special mounting, designed to permit viewing both sides of this historic and beautiful coin, and accompanied by a Certificate of Authenticity certifying to its uniqueness as a first-day-of-issue. Truly a collector's item for every American.

ORDER QUICKLY — PRICE GUARANTEED ONLY 30 DAYS!

Even though the price of gold has risen to record heights, the Westport Mint guarantees to fill orders for this Limited Edition at the offering price of \$5 per coin, for a period of 30 days following the cover date of this publication. Orders will be filled on a first-come, first served basis until the supply is exhausted. So to avoid disappointment, we suggest you mail the order form today!

© 1979 The Westport Mint
60 Wilton Rd., Westport, CT 06880

MAIL NO-RISK COUPON TODAY

THE WESTPORT MINT, Dept. GSA-104
60 Wilton Road, Westport, CT 06880

Please send me _____ Gold-Plated Susan B. Anthony U.S. Dollar(s) with a First-Day-Of-Issue certificate(s) at only \$5 plus 65¢ postage, insurance, handling each.

SAVE: Order the dollar and certificate with a walnut finished display frame for only \$9.98 — we'll pay postage, insurance, and handling.

Quantity Order Savings: Order 5 "Golden Susans" for only \$22.50 postpaid. Order 10 "Golden Susans" for only \$39.95 postage paid; 25 "Golden Susans" for only \$87.50 postage paid. Keep some, use remainder for unique gifts or tips at holiday time!

If after receiving my order I'm not delighted, I may return it within 14 days and you will refund the full purchase price.

Total amount enclosed \$_____ CT residents add 7% Sales Tax. Check or money order, no C.O.D.'s please.

Charge it please (for orders over \$10) to: American Express
 Visa Master Charge (Bank Number _____)

Card No. _____ Expiration Date _____

Name _____

Address _____ Apt. # _____

City _____ State _____ Zip _____

INVENTORY ADJUSTMENT SPECIAL!

PILOT'S GLASSES AT UNBELIEVABLE PRICES!

ONLY \$6.95



- Impact Resistant
- Handcrafted
- Polished Glass Lenses
- Hardened Metal Frames
- Money Back Guarantee

To order, send check or money order (include \$1.00 for postage and handling) to U.S. Optics, Dept. 314, P.O. Box 14206 Atlanta, GA 30324. (Please specify gold or silver frames.) **SPECIAL:** Order now and get **TWO PAIR** for \$13 plus one dollar handling charge.

FREE! During this limited offer.
Deluxe velour lined protective case. A \$3.00 value.

LIMITED OFFER FROM U.S. OPTICS

ELEVATORS®
 Superb Shoes for Men
 Who Want to Look TALLER



26 Numbers for Dress, Business or Casual Wear.

This handsome shoe is one of the famous ELEVATORS®, specially designed to make a man look about TWO INCHES TALLER! The man who wears them knows their amazing secret . . . everyone else only knows how much better he looks. Sold by mail and Guaranteed by the ONLY maker of these remarkable shoes. Send for FREE Catalog, showing the wide style selection of ELEVATORS®.

RICHLIEE Shoe Company
1049 Lake St., Brockton, Mass. 02403

Send me FREE catalog of ELEVATORS® shoes, without obligation now or ever.

Name _____

Address _____

City _____ State _____ Zip _____

TILLER USERS...
 Can your machine do all of this?

- ★ Handle with just ONE HAND.
- ★ EVENLY break, turn & till soil.
- ★ Shred vegetation without tangling.
- ★ Leave NO WHEELMARKS or FOOTPRINTS.

The TROY-BILT® ROTO TILLER-POWER COMPOSTER can do all this and more! That's why serious gardeners consider it the finest tiller available. See for yourself! For complete details, OFF-SEASON SAVINGS, and FREE 24-page booklet clip this and mail today to:

TROY-BILT® Tillers
102nd St. & Ninth Ave., Troy, N.Y. 12180



TROY-BILT® Roto Tiller-Power Composters
Dept. 90550
102nd St. & 9th Ave., Troy, N.Y. 12180

Please send the whole wonderful story of TROY-BILT® Roto Tillers including prices and OFF-SEASON-SAVINGS now in effect for a limited time. (Please Print Clearly)

Mr. _____
 Mrs. _____
 Ms. _____
 Address _____
 City _____
 State _____ Zip _____

THE PERFECT GIFT

Trick Shots
ON THE POOL TABLE

BEAUTIFUL LARGE DIAGRAMS
HAVE FUN • AMAZE YOUR FRIENDS

- 1 Ten Shots For The Beginner..... \$7.
- 2 Ten Shots For Advanced Player.... \$7.
- 3 Ten Professional Trick Shots..... \$7.
- 4 Eight Three Cushion Shots..... \$6.
- 5 Six Propositions To Wager On..... \$5.
- 6 Complete Set of 44 Trick Shots... \$20.
- 7 Complete Gift Set of 44 Trick Shots In Neat 6 Ring Binder..... \$25.

.....ORDER BY NUMBER.....

SEND CHECK OR MONEY ORDER TO:
TRICK SHOTS • P. O. BOX 2215
 LYNCHBURG, VA. 24501

NEW SPACE-AGE PAINT STRIPPER *WHISKS LIKE A SPONGE!*

Strips Away Old Paint, Varnish AND Years Of Accumulated Grime



Now Strip Away Anything **FAST!**

- No Sanding • No Blasting • No Scraping • No Burning
- No Dangerous Power Tools • No Harmful Chemicals

MEET THE STRIPPER! It's space age science's super efficient paint and varnish remover that erases away, strips away, whisks away caked paint, tough varnish and years of grime with light easy strokes. That's not a promise—THAT'S A GUARANTEE! You'll be absolutely amazed at the results. THE STRIPPER moves across facades and veneers easily as it turns those caked, scarred, crusty surfaces into smooth, bare finishes F-A-S-T!

THE STRIPPER works just as well on all kinds of tough problems without sanding—without scraping—without burning or blasting—without harsh chemicals or power tools. So powerful it **STOPS RUST DEAD IN ITS TRACKS** as you erase those ugly stubborn patches down quickly to clean, bare metal. **No hard rubbing!** Just light erasing motions and you strip paint, varnish, rust, etc., from furniture, walls, doors, cabinets, boats, grills, cars, pipes, etc. Perfect for tackling thousands of tough, nasty jobs. It ends the need for sandpaper and caustic solvents.

The result of space age technology THE STRIPPER has thousands upon thousands of microscopic points that work efficiently and scientifically to strip away, whisk away, erase away old paint, rust and varnish with a simple erasing motion.

RESULTS GUARANTEED—TRY AT OUR RISK
The Stripper that looks and weighs like a sponge comes to you with this amazing "Use it and abuse it" no non-sense guarantee: Tackle your toughest jobs. Be amazed at how much labor the Stripper saves you. If you are not pleased and delighted with its incredible performance return within 14 days for a full refund of your purchase price (less postage and handling, of course). Order today.

This photographic accentuation helps depict the whisk-away action of the wonderful Space-Age Paint Stripper.

DOES ALL THIS:

- ✓ "Whisks-off" years and years of old paint.
- ✓ Strips away rust down to bare metal fast!
- ✓ Restores furniture to smooth paint-free finish.
- ✓ "Erases" years of grime and varnish as if by magic.
- ✓ Perfect for hundreds of jobs on walls, doors, cabinets, cars, grills, furniture, etc.

REMOVES RUST CONTOUR CONTROL WHISK AWAY ACTION

© 1978 Encore House, Inc. Roberts Lane, Glen Head, NY 11545

MAIL THIS NO-RISK COUPON TODAY

SPACE-AGE STRIPPER, Dept. SAS-153
Roberts Lane, Glen Head, NY 11545

Please RUSH me the Incredible SPACE-AGE PAINT STRIPPER(s) with the understanding that if I am not completely thrilled and delighted with the way it completes my toughest jobs I may return for a full refund of my purchase price within 14 days (less postage and handling, of course). Check offer desired:

(#001) 1 Carton of Six Strippers for only \$7.95 plus 50¢ post. and hand.
 (#002) **SAVE \$3.20!**—2 Cartons for only \$12.95 plus 75¢ post. and hand.
 (#003) **SAVE \$7.40!**—3 Cartons only \$16.95 plus \$1 postage and handling.

Amount enclosed \$ _____ (NY residents please add sales tax).
 No C.O.D.'s please.

CHARGE IT! VISA (BankAmericard) Exp. Date: _____
 Master Charge

Credit Card # _____
 Name _____
 Address _____
 City _____ State _____ Zip _____

Yes Haband, I want to try your remarkable shoes! **2 Pairs for 24.95**

HABAND COMPANY
 265 No. 9th St., Paterson, NJ 07530

Yes! Please send me _____ pairs, for which I enclose \$ _____ plus \$1.25 towards postage and handling. I understand that if for any reason I don't wish to wear the shoes after they arrive, I may return them within 30 days for full refund of every penny I paid you.

PRODUCT NUMBER 72J-437

Color/Style	Qty.	Size	Width
Brown Tassel Loafer			
Brown Slip-On			
Brown Oxford			
Black Slip-On			
Brown Boot			
Black Boot			

ADDITIONAL SAVINGS:
 3 pairs for 37.35 4 pairs for 49.70

Name _____
 Street _____ Apt. # _____
 City/State _____ Zip _____

CUSTOM MADE EMBLEMS

Organizations, Schools, Churches, Commercial Fund Raising and etc. Free Brochure Dept. CM 10E

EMBLEMATIC JEWELRY
 ELKS, K of C., MASONS, ETC.
 Free brochure Dept. EJ 12E
 Fraternal Wholesaler Jewelry Mfg. Co.
 P.O. Box 8123, Cranston, R.I. 02920
 (401) 942-4591

E15 \$1.00 ea.
 p.p. 25c

Help!

The Elks Magazine postage fees have skyrocketed!

Help us cut costs by reporting any address change to your lodge secretary and *The Elks Magazine* Circulation Department.

Be sure to include lodge and membership number or an address label from the magazine. **Notice should be sent 6 to 8 weeks before your move.**

ATTACH ADDRESS LABEL HERE

New Address:

Name _____
 Address _____
 City _____
 State _____ Zip _____
 Lodge No. _____
 Member No. _____

Mail to: Circulation Manager
 The Elks Magazine
 425 W. Diversey Pwy.
 Chicago, IL 60614

10-9

BINGO PLAYERS' DELIGHT

Save Time, Play More Cards.
 Bingo Maggi™ kit is easy to use, just pass wand over your cards and presto chips jump up and attach to it for Speedy Collection, ready for the next game. Excellent tool and gift for all bingo players. Yellow or green Magnetic Wand with 100 chips, \$3.75 plus 50¢ post. Extra chips available in colors red, green, violet, pink or blue. \$1.70 per hundred.

SEAT FOR BINGO and any place you need comfort and support when seated for a long time. Firm cushion and back rest are each 2 1/2" thick.

A CARRY-ALL TOO. Just close cushions together and make a light carry-all. With handles at one end, large elastic pouch and self-locking flap, it allows you to carry all bingo supplies. Choice of five attractive colors: red, denim, blue, beige or brown with Bingo card design. Strong, hand-sewn. Guaranteed for one year against defects in workmanship and material. \$14.95 plus \$2.00 hdlg. & shpg.

MOHAWK GIFTWARE AND COIN SHOP
 9 Market St., Dept. E
 Amsterdam, N. Y. 12010

**POPULAR BLAZER IN
SOFT PIGSKIN LEATHER**
SALE PRICE **\$99** REG \$125
ONLY

What a great fashion investment this blazer will be for your wardrobe! Soft and supple, its classic styling and pigskin's natural ageless beauty make it a remarkable buy at only \$99.

The "Eaton" is meticulously tailored to add new dimensions to your blazer way of life. Updated styling with narrow notched lapels and traditional patch pockets. The back is smartly set off by curved seam detailing and center vent. Fully rayon lined, with 3 inner pockets. This durable, comfortable blazer will take you from office...to after-hour engagements...to weekend outings. You'll be gathering compliments for many seasons to come. A truly exceptional value. Specify Golden Tan or Golden Brown.

Available in even sizes only, 36 to 46. Only \$99
Long sizes 40, 42, 44, 46. Only \$109

BERMANS
THE LEATHER EXPERTS

MONEY BACK GUARANTEE!
MAIL NO-RISK COUPON TODAY

BERMANS LEATHER DIRECTIONS
113 27th Ave. N.E., Minneapolis, MN 55418
USE YOUR MAJOR CREDIT CARD
PHONE 1-800-328-2411

(In Minnesota, Call Collect 612-789-4381)

Please send me the following "Eaton" Sueded Pigskin Blazer(s):

Regular Sizes (36 to 46) **\$99:**
 Golden Tan (I-8021-AA) Golden Brown (I-8022-AA) SIZE _____

Long Sizes (40, 42, 44, 46) **\$109:**
 Golden Tan (I-8023-AA) Golden Brown (I-8024-AA) SIZE _____

Add \$3.00 postage and handling per blazer.
 Check Money Order enclosed for complete total of \$_____

I understand that if I am not fully satisfied, I may return blazer(s) for a complete refund of the purchase price.

Charge to: CB MC VISA AE DC

Card # _____ Exp. Date _____

Name _____

Address _____

City _____ State _____ Zip _____

Prices effective through March 31, 1980



U.S. Air Mail

Get your collection off the ground with Winged Globe, Statue of Liberty, The American Eagle, Abraham Lincoln, Liberty Bell, plus more! We'll also include selections for you to examine. Keep only those you wish to buy, return any others. Cancel service anytime.

ONLY **25¢**

Send 25¢ today to: **GARCELON STAMP CO., Dept. EMOS, Calais, Maine 04619**

Catalog Value \$1.24

39 TIPS

TO A MORE EFFECTIVE RESUME

From a Personnel Professional who reads thousands of them

Do you have the right qualifications but just can't get the job? Are you looking for your first job? Are you over 40 (or 50) and worried? Is your resume doing a job for you...or is it hurting your chances? Do you have trouble when writing a resume? Read these straight-to-the-point tips. Learn how to avoid common errors. You'll improve your career battling average! **SAMPLES INCLUDED!** Send \$3.95 (check or money order) to:

Professional Personnel Services

POST OFFICE BOX #116 / ROMEO, MICHIGAN / 48065

L.L.Bean®

Outdoor Sporting Specialties



Touring Cap

Attractive and sturdy sports cap of brushed pigskin leather. Pigskin "breathes", is flexible and retains shape. Impregnated with Scotchgard®, highly rain resistant, with snapped down visor. Fully Rayon lined. Easily cleaned by brushing. Color, Taupe. Sizes, Sm. (6½-6¾), Med. (7-7½), Lg. (7½-7¾), XLg. (7¾-7⅞). Price \$11.50 ppd.

SEND FREE CATALOG

Please Ship Postpaid
Touring Cap @ \$11.50, Size _____

Check Enclosed American Express
 VISA Master Charge

Card No. _____

Exp. Date _____

Name _____

Address _____

City _____

State _____ Zip _____

L. L. Bean, Inc.

7161 Cedar St., Freeport, ME 04033

TALL OR BIG MEN

*Sick of
Being
Sold Short?*



HAGGAR®

Most men's clothing stores successfully ignore the very existence of Tall, Extra Tall and Big Men by trying to sell you outdated styles... at outrageous prices.

Not The KING-SIZE Co... we cater to Tall, Extra Tall and Big Men with the world's best selection of fashionable clothing and shoes in hard-to-find sizes... all reasonably priced! Shirts, Sweaters, Suits, Slacks & Jackets with Sleeves to 38" ... necks to 22" ... inseams to 39" ... waists to 60". Shoes and Boots to 16EEE.

All Guaranteed both Before and After Wearing, Washing and Dry Cleaning...or MONEY BACK.

FREE 100 PAGE CATALOG

My Telephone Number _____
Area _____
Height _____ Weight _____ Shoe Size _____
NAME _____
ADDRESS _____
CITY _____ STATE _____ ZIP _____
THE King-Size Co. 2539 King-Size Bldg.
Brockton, MA 02402

Medicare Approved



EASY-LIFT® Cushion Lifting Chair

- Power cushion gently lifts you to a standing position
- Full, power recline feature
- Simple switch control
- Runs off household current
- Variety of colors, models and fabrics

AMERICAN STAIR-GLIDE CORP.

4001 East 138th Street, Dept. EE-109
Grandview, Missouri 64030

Retire to a riverfront community in Florida.

Colony Cove, a Florida prestige adult mobile home community on the Cotee River in New Port Richey is just 25 miles north of Tampa. With Florida's unusual seasonal climate, relax in the heated pool at our riverside clubhouse year round. Located in a natural wood setting, enjoy bicycling, shuffleboard, fishing and boating with direct access to the Gulf of Mexico. From \$21,900. Send in coupon for free brochure

or call toll-free
1-800-237-9883.



Colony Cove
at New Port Richey

Name _____
Address _____ City _____
State _____ Zip _____ Phone _____

Mail coupon to: Colony Cove
738 C-518, Box 280, New Port Richey, Florida 33552
I plan to move to Florida in _____ 50
 1979 1980 _____ When?

BINGO

FOR PERMANENT
FUND RAISING

Easy way to raise money for your Organization because everyone has fun playing BINGO! Thousands of Organizations are making up to \$500.00 per week using "BINGO KING" supplies and FREE Idea Bulletins. Write for FREE catalog and details on raising money for your Organization.

PLEASE GIVE NAME OF ORGANIZATION.

'BINGO KING'
DEPT. EL-79, BOX 2499, LITTLETON, COLO. 80161

WANTED

Old Saloon Bars and Back Bars.
Stained Glass Windows.
Top Prices Paid.

Send description, Price, Photos, To:

SHEFFIELD'S
5977 Delmar, Saint Louis, MO 63112
OR CALL: 314-727-2411

HEARING AIDS

SUPER SAVINGS! Newest, Finest. All types. Buy DIRECT & save up to HALF! No salesmen. Sold by AIR MAIL on HOME TRIAL. FREE Catalog. Write: **MONEYSAVERS**, Dept. EK-10, 9530 Langdon Ave., Sepulveda, Cal. 91343

SAVE 1/2!

FREE CATALOG — WRITE!

LAPEL PINS

YOUR DESIGN molded in 3 dimensions, rich colors. Choice of backs, Golf Ball Markers, Push Pins, etc. 1¢ to 14¢ ea (min. 1000) plus 1-time mold charge. Free literature, or \$1 for samples (deductible on order).

KNOBBY KRAFTERS Dept. E
P.O. Box 300, Attleboro, Mass. 02703
Phone (617) 222-7272

Fund-raising, Give-Aways,
Membership Drives, Con-
vention Sweeps



A REMARKABLE NEW CHESS MACHINE

CYBERCHESS. Far superior to \$300 computers. Experts call it ingenious. Plays and teaches. Guaranteed to ignite your game. Under \$35. Write for literature.

CYBERCHESS, Dept. S29, 17517 Fabrica Way,
P.O. Box 2066, Cerritos, CA. 90701



Major Projects

(Continued from page 18)

using worldwide tours and vacations as a vehicle for raising money for the state's scholarship program. Whether or not the institution of such a plan would be lucrative enough to be worth the necessary effort was, at that time, questionable. Since then, the operation of the Tour Committee has proven to be a success. Thousands of Elks and Elks' ladies have taken advantage of the group and charter flight plans arranged by the Tour Committee. All expenses involved in publicizing the tours are paid with funds from the Massachusetts Elks Association budget. All donations from travel agents and other organizations with an interest in the tours are therefore utilized to augment the scholarship fund.

Another way in which Massachusetts Elks support their major project is a

statewide, annual raffle. The funds raised through the raffle reach an average of \$75,000 per year. Various organizations benefit from the proceeds, which are distributed as charity awards. A total of \$77,000 was donated as awards in 1978-1979.

All lodges participate in supporting the major project. Administrative and organizational duties are assumed on a volunteer basis by members of the state association. Grand Trustee Alfred Mattei serves as president of the Scholarship Fund, while GL Committeeman Arthur Kochakian directs the Tour Committee, and PDD Dominic Dululio, chairman of the GL Americanism Committee, administers the Charity Awards Program. The combined leadership and active participation in both aspects of the major project provides for aid to those in need and the promotion of education for America's youth.

Former Elks National Foundation Winner



Norman E. Fretwell

Chosen as one of its Most Valuable Students by the Elks National Foundation in 1962, Norman E. Fretwell entered West Point, where he distinguished himself by attaining a position on the Dean's List and becoming Class President in his sophomore, junior and senior years. Also, in his concluding year at West Point, he was selected as Brigade Commander of Corps of Cadets and was the proud recipient of the Pershing Sword Award for most outstanding leadership accomplishments.

An Army career awaited Mr. Fretwell after graduation, and he attended Airborne and Ranger Schools, becoming a paratrooper with the 101st Airborne Division. The faith placed in him by his superiors was soon to be tested in combat in Vietnam—and First Lieutenant Fretwell performed under fire with bravery and honor, receiving the Bronze Star for heroism in combat.

Before leaving Vietnam in 1968, Mr. Fretwell was commissioned Captain and, subsequently, was sent to West Berlin, where he served as the Senior Aide to the U.S. Commander.

His military obligations fulfilled in honorable fashion, Mr. Fretwell attended Michigan Law School for postgraduate education and graduated with a Doctor of Jurisprudence degree.

Since 1973, Mr. Fretwell has practiced law with the firm of Watson, Ess, Marshall & Enggas in Kansas City, MO, his practice focusing on business-related matters, including corporate, banking and securities work. Once again distinguishing himself as he had in Vietnam, he was made a partner in the firm on July 1, 1979.

Mr. Fretwell's service to his fellow man continued with his participation in various civic activities. He served on the Board of Directors of the Kansas City Boys Club and lent his expertise to many Boy Scout committees. He has taught basic law to students in inner-city schools in connection with local bar association programs and, for the past 10 years, has been on the staff of Missouri Boys State. This will be the fifth year that Mr. Fretwell has served as the Dean of Counselors of Missouri Boys State, wherein he conducts a week-long experience in politics and government for approximately 1,000 high school students living in Missouri.

Norman E. Fretwell, former Elks National Foundation Winner, continues to serve his community in the finest tradition of Elkdom.

Our gratitude to Jack Brubaker, Exalted Ruler of Joplin, MO, Lodge No. 501, and Curt Wiggins, Youth Activities Committee Member, for their kind assistance in compiling this information.

100%
man-made
in U.S.A.

HABAND = INCREDIBLE SAVINGS, and the \$60 AND UP LOOK!

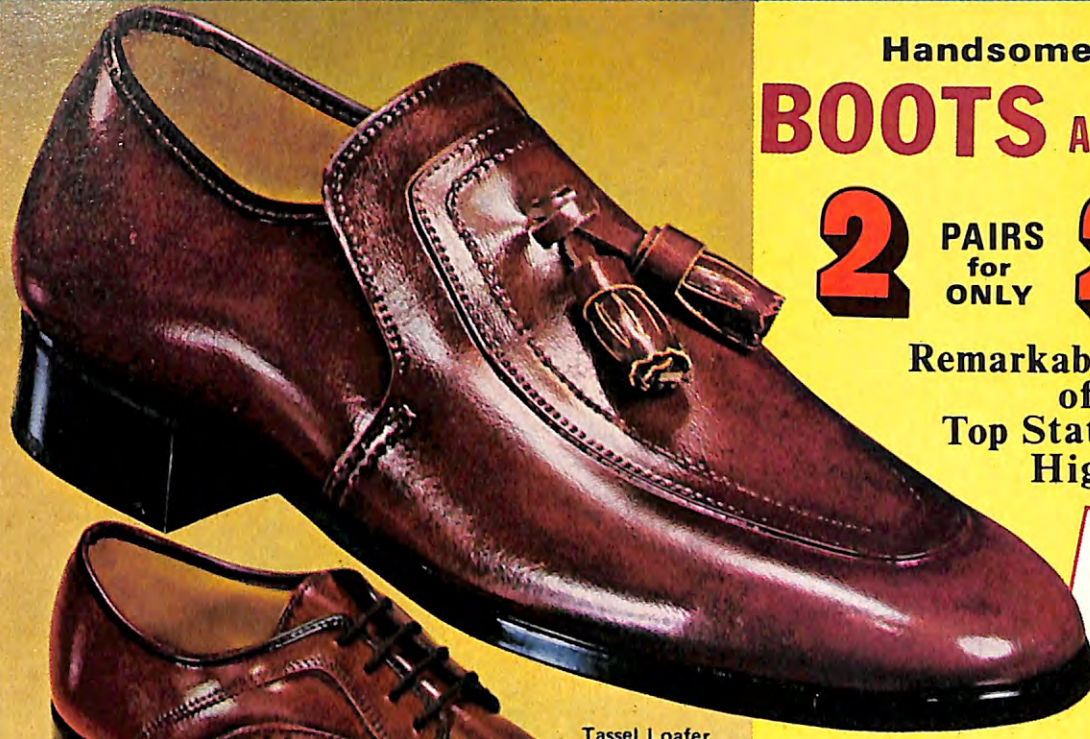

Tassel Loafer



Oxford



Black Slip-On



Brown Slip-On

Handsome, Luxurious
BOOTS AND SHOES

2 PAIRS
for
ONLY **24⁹⁵**

Remarkable Reproductions
of the
Top Status, Top Fashion
High Priced Shoes!

**THOUSANDS of PAIRS
SOLD EVERY WEEK
THROUGH THE
U.S. MAILS!**

With all the
**Flex, Cushion, and Support
You Need for Complete Comfort!**

- Beautifully grained, richly antiqued 100% man-made discovery looks and feels and wears like leather, yet costs so much less!
- Soft and Supple, they need no break-in.
- Absolutely weatherproof, and they never need a shine!

It's true! Haband, the mail order people from Paterson, N.J., sell their fine executive dress shoes to over two-million business and professional men all over America. It is a fast, reliable way to get good shoes in your exact size and the newest executive styles direct to your home — no running around!

And right now is an excellent time to get acquainted. These are all the newest styles, just out of the top designer showrooms, but at substantial savings when you order from Haband. Have you seen the price of leather shoes lately? At that rate, it is inevitable: Sooner or later you will be buying the New Price Shoes from Haband. Why not sooner? You get perfect fit in your exact size and fast reliable service.

**IS
YOUR
SIZE
on this
CHART?**

	5½	6	6½	7	7½	8	8½	9	9½	10	10½	11	12	13
A														
B														
C														
D	✓	✓	✓	✓	✓	✓	✓	✓	✓	✓	✓	✓	✓	✓
E		✓	✓	✓	✓	✓	✓	✓	✓	✓	✓	✓	✓	✓
EEE			✓	✓	✓	✓	✓	✓	✓	✓	✓	✓	✓	✓

100% NO RISK GUARANTEE
**Yes Haband, I Want to Try
Your Remarkable Shoes!** **2** Pairs for **24⁹⁵**

HABAND COMPANY
265 North 9th St., Paterson, NJ 07530

Yes! Please send me pairs, for which I enclose \$ plus \$1.25 towards postage and handling. I understand that if for any reason I don't wish to wear the shoes after they arrive, I may return them within 30 days for full refund of every penny I paid you.

PRODUCT NO. 72J-437

Color/Style	Qty	Size	Width
Brown Tassel LOAFER			
Brown SLIP-ON			
Brown OXFORD			
Black SLIP-ON			
Brown BOOT			
Black BOOT			

Name _____ Apt. _____
Street _____ # _____
City/State _____ Zip _____

Additional Savings:
3 pairs for 37.35
4 pairs for 49.70



HABAND

265 N. 9th St., Paterson, N.J. 07530

Boot (in Black or Brown)

HABAND — Doing business by U.S. Mail since 1925.

Super Sours begin with Seven.



For a super Whiskey Sour, start with the very special taste of Seagram's 7 Crown. Add 1½ oz. Seagram's 7 to the juice of one lemon and one tsp. of extra fine sugar. Shake, strain over ice and garnish with an orange slice and a cherry. A Seagram's 7 Sour is super! Enjoy our quality in moderation.

Seagram's 7 Crown
Where quality drinks begin.

